

Operation Guide

TASKalfa MA4500ci TASKalfa MA3500ci

2023.2
2Z7KDEN000



Contents

1	Please Read First	1
	Preface	2
	Machine Features	4
	Optimize your office workflow	4
	Save energy and cost	6
	Create attractive documents	7
	Strengthen security	8
	Use functions more efficiently	10
	Color and Image Quality Functions	13
	Basic Color Modes	13
	Adjusting Image Quality and Color	15
	Guides Provided with the Machine	17
	About the Operation Guide (this Guide)	19
	Structure of the guide	19
	Conventions Used in This Guide	20
	Notice	25
	Safety Conventions in This Guide	25
	Environment	26
	Precautions for Use	27
	SAFETY OF LASER BEAM (USA)	28
	Safety Instructions Regarding the Disconnection of Power	29
	Compliance and Conformity	29
	Radio Tag Technology	30
	Other precautions (for users in California, the United States)	30
	Warranty (the United States and Canada)	31
	Legal Restriction on Copying/Scanning	32
	Wireless Connection (Mexico only)	33
	Security Precautions when Using Wireless LAN (If equipped)	34
	Limited Use of This Product (If equipped)	35
	Legal and Safety Information	36
	Energy Saving Control Function	38
	Automatic 2-Sided Print Function	38
	Resource Saving - Paper	38
	Environmental benefits of "Power Management"	38
	ENERGY STAR Program	39
2	Installing and Setting up the Machine	40
	Part Names (Machine Exterior)	41
	Part Names (Connectors/Interior)	43
	Part Names (With Optional Equipments Attached)	45
	Connecting the Machine and Other Devices	46
	Connecting Cables	48
	Connecting LAN Cable	48
	Connecting USB Cable	49
	Connecting the Power Cable	49
	Power On/Off	50
	Power on	50
	Power off	50
	Using the Operation Panel	51
	Operation Panel Keys	51
	Assigning Functions to Function Keys	53
	Adjusting the Operation Panel Angle	55
	Touch Panel	56
	Using the Touch Panel	56
	Home screen	59

Display for Device Information	65
Display Setting Screen	66
Display of Keys That Cannot Be Set	68
Original Preview	70
Entering Numbers	72
Help Screen	74
Accessibility Functions (Magnifying the View)	75
Login/Logout	76
Login	76
Simple Login	77
Logout	77
Default Settings of the Machine	78
Setting Date and Time	78
Network Setup	79
Energy Saver function	91
Quick Setup Wizard	93
Configuring Settings Quick Setup Wizard	95
Installing Software	96
Published Software (Windows)	96
Installing Software in Windows	98
Uninstalling Windows Software	105
Installing Software on a Mac OS Computer	107
Setting TWAIN Driver	112
Setting WIA Driver	114
Checking the Counter	116
Additional Preparations for the Administrator	117
Administrator Privileges Overview	117
Log in as Machine Administrator or Administrator	117
Strengthening the Security	118
Command Center RX	121
Accessing Command Center RX	122
Changing Security Settings	123
Changing Device Information	124
SMTP and E-mail Settings	125
Registering Destinations	129
Creating a New Custom Box	130
Printing a Document Stored in a Custom Box	131
Transferring Data from Our Other Products	133
Migrating the Address Book	133

3 Preparation before Use 141

Load Paper	142
Loading Paper	142
Precaution for Loading Paper	144
Paper Specifications available in the Cassettes	145
Loading in the Cassettes	146
Paper Specifications available in the Multipurpose Tray	149
Loading Paper in the Multipurpose Tray	150
Specifying Paper Size and Media Type	152
Paper Stopper	155
Preparation for Sending a Document to a Shared Folder in a PC	156
Making a Note of the Computer Name and Full Computer Name	156
Making a Note of the User Name and Domain Name	157
Creating a Shared Folder, Making a Note of a Shared Folder	158
Configuring Windows Firewall	163
Scan to Folder Setup Tool for SMB	168
Registering Destinations in the Address Book	173
Adding a Destination (Address Book)	173
Adding a Destination on One Touch Key	185

4	Print from PC	188
	Printer Driver Print Settings Screen	189
	Displaying the Printer Driver Help	191
	Changing the Default Printer Driver Settings (Windows 10)	192
	Changing the Default Printer Driver Settings (Windows 11)	192
	Changing the Default Printer Driver Settings (Windows 8.1, Windows 2012)	192
	Printing from PC	193
	Printing on Standard Sized Paper	194
	Printing on Non-standard Sized Paper	196
	Printing with Universal Print	199
	Printing on Banner Paper	202
	Canceling Printing from a Computer	205
	Printing from the Mobile Device	206
	Printing by AirPrint	206
	Printing by Mopria	206
	Printing with Wi-Fi Direct	206
	Printing Data Saved in the Printer	207
	Specifying the Job Box from a Computer and Storing the Job	207
	Printing Documents from Private Print Box	208
	Deleting the Documents Stored in the Private Print Box	209
	Printing Document from Stored Job Box	210
	Deleting the Documents Stored in the Stored Job Box	211
	Printing Document from Quick Copy Box	212
	Deleting the Documents Stored in the Quick Copy Box	213
	Printing Document from Proof and Hold Box	214
	Deleting the Documents Stored in the Proof and Hold Box	214
	Printing Documents from PIN Print Box	215
	Deleting the Documents Stored in the PIN Print Box	215
	Printing Document from Universal Print Box	216
	Deleting the Documents Stored in the Universal Print Box	217
	Monitoring the Printer Status (Status Monitor)	218
	Accessing the Status Monitor	218
	Exiting the Status Monitor	218
	Quick View State	218
	Printing progress tab	219
	Paper tray status tab	219
	Toner Status Tab	220
	Alert tab	220
	Status Monitor Context Menu	221
	Status Monitor Notification Settings	222
5	Operation on the Machine	224
	Loading Originals	225
	Placing Originals on the Platen	225
	Original Specifications available in the Document Processor	227
	Recalling Frequently Used Functions (Favorites)	230
	Register Favorites (Wizard Mode)	233
	Register Favorites (Program Mode)	233
	Recalling Favorites (Program Mode)	235
	Recalling Favorites (Wizard Mode)	235
	Editing Favorites	236
	Deleting Favorites	237
	Using Applications	238
	Installing Applications	238
	Activating Applications	239
	Deactivating Applications	240
	Uninstalling Applications	241
	Registering Shortcuts (Copy, Send, and Document Box Settings)	242
	Creating new shortcuts	242

Editing Shortcuts	243
Deleting Shortcuts	244
Copying	245
Basic Operation	245
Canceling Jobs	246
Basic Scanning (Sending)	247
Sending Document via E-mail	248
Sending Document to Desired Shared Folder on a Computer (Scan to PC)	250
Sending Document to Folder on an FTP Server (Scan to FTP)	253
Scanning using TWAIN or WIA	256
Scanning Document stored in a Custom Box	257
Useful Sending Method	259
WSD Scan	260
Install the Driver (for Windows 10)	260
Install the Driver (for Windows 11)	260
Install the Driver (for Windows 8.1, Microsoft Windows Server 2012)	260
Executing WSD scan	261
Scanning with FMU Connection	262
Sending to different types of destinations (Multi sending)	263
Sending to different types of destinations	263
Sending Documents to E-mail Address of Logged in User (to myself)	265
Using a Fax Server to Send (Fax Server Send)	266
Canceling Sending Jobs	268
Handling Destination	269
Specifying Destination	269
Choosing from the Address Book	270
Choosing from One Touch Key	271
Choosing from the Search (No.)	272
Checking and Editing Destinations	272
Confirmation Screen of Destinations	273
Re-enter new recipient information.	274
Recall	274
How to use the FAX Function	275
Using Document Boxes	276
What is Custom Box?	276
What is Job Box?	276
What is USB Drive Box?	277
What is a Fax Memory RX Box/Subaddress Box/Polling Box?	277
Basic Operation for Document Box	278
Creating a New Custom Box	283
Editing Custom Box	285
Delete the box.	286
Storing Documents to a Custom Box	287
Printing Document in a Custom Box	288
Saving scanned documents to a Custom Box	289
Sending Documents in a Custom Box	290
Sending Documents to E-mail Address of Logged in User (to myself)	291
Moving Documents in Custom Box	292
Copying Documents in Custom Box into Other Boxes	293
Copying Documents in Custom Box to USB Drive	294
Joining Documents in Custom Box	295
Deleting Documents in Custom Box	296
Using Removable USB Drive	297
Printing Documents Stored in Removable USB Drive	298
Saving Documents to USB Drive (Scan to USB)	300
Check the USB Drive Information	301
Removing USB Drive	301

6	Using Various Functions	302
	About Functions Available on the Machine	303
	Copy	303
	Send	306
	Custom Box (Store File, Print, Send)	310
	USB Drive (Store File, Printing Documents)	316
	Functions	320
	Original Size	321
	Paper Selection	323
	Mixed Size Originals	325
	Original Orientation	328
	Collate	330
	ID Card Copy	331
	Density	332
	Original Image	333
	EcoPrint	336
	Color Selection	337
	Color Balance	338
	Hue Adjustment	339
	Sharpness	341
	Background Density Adj.	342
	Saturation	343
	Prevent Bleed-thru	344
	Contrast	345
	Erase Colors	346
	Zoom	347
	Combine	349
	Border Erase, Border Erase/Full Scan	352
	Duplex	356
	Continuous Scan	361
	Job Finish Notice	362
	File Name Entry	363
	Priority Override	364
	Quiet Mode	365
	Detect Multi-fed Originals	366
	Detect Folded Corner Orig.	367
	Skip Blank Page	368
	Duplex	369
	Sending Size	370
	Long Original	372
	File format	373
	File Separation	382
	Scan Resolution, Resolution	383
	Clarify Text (Noise Removal)	384
	Email Subject/Body	385
	FTP Encrypted TX	386
	Email Encrypted TX	387
	Digital Signature to Email	388
	Delete after Printed	390
	Delete after Transmitted	390
	Storing Size	391
	Encrypted PDF Password	393
	JPEG/TIFF Print	394
	XPS Fit to Page	395
7	Status/Job Cancel	396
	Checking Job Status	397
	Displaying Status Screens	398
	Details of the Status Screens	399

Checking Detailed Information of Jobs	405
Checking Job History	406
Displaying Job History Screen	407
Checking the Detailed Information of Histories	407
Sending the Log History	407
Job Operation	408
Pause and Resumption of Jobs	408
Canceling of Jobs	408
Device Information	409
Checking the Remaining Amount of Toner and Aaper, and the Condition of the Unit	411

8 System Menu 412

Operation Method	413
System Menu Settings	415
DeviceSettings	420
Language/System of Units	420
Keyboard	420
Numeric Keypad	420
Date/Time	421
Energy Saver/Timer	422
Display Settings	425
Sound	427
Original/Scan Settings	428
Paper Feeding	430
Function Key Assignment	438
Operation Assist	439
Error Handling	440
Toner Settings	441
Notification/Report	442
Print Report/List	442
Result Report Setting	445
Device Status Notification	446
Fax Communication Report	446
History Settings	447
FunctionSettings	449
Function Defaults	449
Copy/Print	455
Send/Store	455
Email	457
Sending Job - Folder	459
Fax	460
WSD	461
Address Book	462
One-Touch Key	463
Send and Forward	464
Forward setting	465
Printer	466
Document Box	470
Job Box	471
Subaddress Box	472
Fax Memory RX Box	472
Home	472
Status	473
Remote Services	474
TWAIN/WIA	475
NetworkSettings	476
Host Name	476
Proxy	476
Wi-Fi Direct Settings	477

Wi-Fi Settings	478
Wired Network Settings	484
Protocol Settings	488
Ping	494
Bonjour	494
IP Filter (IPv4)	494
IP Filter (IPv6)	494
IPSec	495
Restart the network	495
Optional Network	496
Connectivity	499
Others	500
SecuritySettings	501
Security Quick Setup	501
Configuring Security Quick Setup	502
Interface Block Setting	503
Device Security Settings	504
Authentication Security	509
Unknown User Settings	509
Network	510
Job Accounting/Authentication	511
Add/DeleteApplication	512
Adjustment/Maintenance	513
Image Adjustment	513
Others	516

9 User Authentication and Accounting (User Login, Job Accounting) 518

Overview of User Login Administration	519
Managing the Job Account from PC	519
Enable User Login Administration	521
Setting User Login Administration	522
Authentication Security	522
Adding a User (Local User List)	524
Changing User Properties	527
Deleting a User	528
Managing the Users that Print on This Machine from a PC	528
Managing the Users to Scan Using TWAIN	530
Managing the Users to Scan Using WIA	531
Managing the Users that Send Faxes from a PC	532
Local Authorization	534
Server Settings	535
Configure Network User Rights	536
Group Authorization Settings	537
Guest Authorization Settings	540
Obtain NW User Property	543
Simple Login Settings	545
ID Card Settings	547
PIN Login	549
Using User Login Administration	549
Overview of Job Accounting	550
Enabling Job Accounting	552
Job Accounting (Local)	553
Adding an Account	553
Restricting the Use of the Machine	554
Editing an Account	556
Deleting an Account	557
Job Accounting for Printing	558
Job Accounting for Scan Using TWAIN	560

	Job Accounting for Scan Using WIA	561
	Job Accounting for the FAX Transmitted from a Computer	562
	Configuring Job Accounting	563
	Default Counter Limit	563
	Counting the Number of Pages Printed	564
	Print Accounting Report	568
	Using Job Accounting	569
	Apply Limit	570
	Copier/Printer Count	571
	Unknown User Settings	572
10	Troubleshooting	574
	Regular Maintenance	575
	Cleaning	575
	Cleaning Platen	575
	Cleaning Slit Glass	576
	Cleaning Paper Transfer Unit	577
	Replacing the Toner Container	578
	Replacing the Waste Toner Box	582
	Troubleshooting	584
	Solving Malfunctions	584
	Machine Operation Trouble	584
	Printed Image Trouble	630
	Color Printing Trouble	643
	Remote Operation	649
	Responding to Messages	652
	List of Transmission Error Codes	676
	Adjustment/Maintenance	719
	Overview of Adjustment/Maintenance	719
	Color Registration Procedure	720
	Perform image adjustment	724
	Clearing Paper Jams	725
	Jam Location Indicators	725
	Remove any jammed paper in the Multipurpose Tray	727
	Remove paper jams from Cassette 1 to Cassette 5	730
	Remove the paper jammed in the Rear Cover 1 (Feed)	732
	Remove the paper jammed in the Rear Cover 2	733
	Remove the paper jammed in the Rear Cover 3	734
	Remove the paper jammed in the Rear Cover 1	735
	Remove any jammed paper in Duplex Unit	737
	Remove any jammed paper in the Document Processor (Reverse Automatic) ...	739
11	Appendix	741
	Optional Equipment	742
	Overview of Optional Equipment	742
	Overview of the Applications	746
	Starting Application Use	746
	Checking Details of Application	747
	Character Entry Method	748
	Entry Screens	748
	Entering Characters	750
	About Paper	751
	Basic Paper Specifications	751
	Choosing the Appropriate Paper	752
	Special Paper	755
	Specifications	760
	Machine	760
	Copy Functions	762
	Printer Function	764

Scanner Functions	766
Document Processor	767
Paper Feeder (550-sheet)	768
Backing up your data	769
Backing up your data using KYOCERA Net Viewer	769
Backing up your data using Command Center RX	769
Backing up your data using USB Drive	770
Security Quick Setup Function List	771
TLS	771
Serverside Settings	771
Clientside Settings	773
IPv4 Settings (Wired Network)	774
IPv4 Settings (Wireless Network)	775
IPv6 Settings (Wired Network)	776
IPv6 Settings (Wireless Network)	777
Send Protocols: FTP Client (Transmission)	778
Other Protocols: HTTP (Client)	779
Other Protocols: SOAP	780
Other Protocols: LDAP	781
Send Protocols: SMTP (E-mail TX)	782
Email: POP3 User Settings	783
Print protocols	784
Send Protocol	786
Other Protocols	787
TCP/IP: Bonjour Settings	789
Network Settings	789
Connectivity	789
Interface Block Setting	790
Energy Saver/Timer	791
User Account Lockout Setting	791
Job Status/Job Logs Settings	791
Edit Restriction	792
Prevent Mis-sending Settings	793
History Settings	794

1 Please Read First

Preface

Thank you for purchasing this machine.

This Operation Guide is intended to help you operate the machine correctly, perform routine maintenance, and take simple troubleshooting measures as needed so that the machine can always be used in the optimum condition.

Please read this Operation Guide before using the machine.

The product illustrations, screens, settings, etc., in this guide may differ depending on the machine you are using.

We recommend the use of our genuine toner containers, which have passed rigorous quality control testing, to maintain quality.

The use of non-genuine toner containers may cause failure.

We will not be liable for any damages caused by the use of third party supplies in this machine.

A label is affixed to our genuine supplies, as shown below.

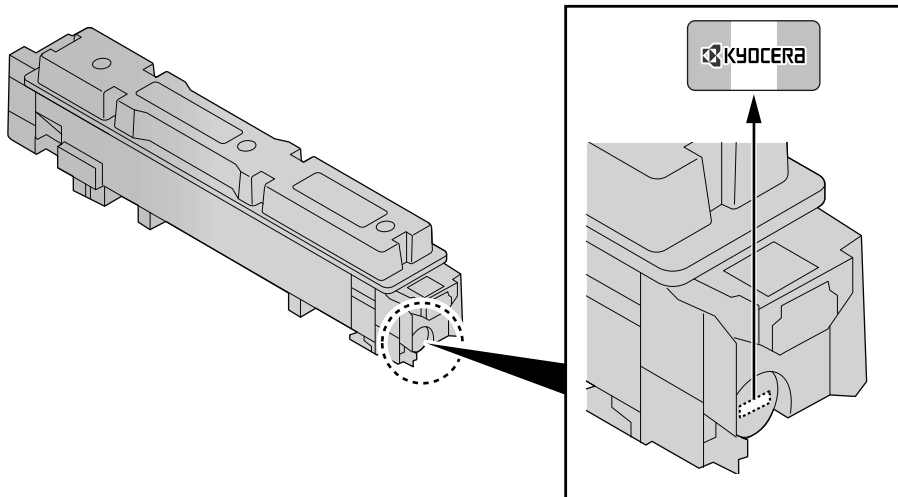

Checking the Equipment's Serial Number

The equipment's serial number is printed in the location shown in the figure.

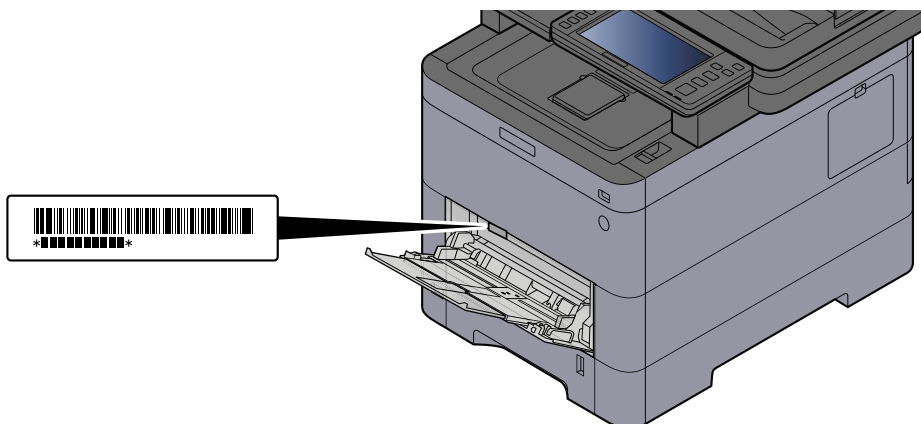

You'll need the equipment's serial number when contacting your Service Representative. Please check the number before contacting your service representative.

Machine Features

The machine is equipped with many useful functions.

➔ [Using Various Functions \(page 302\)](#)

Here are some examples.

Optimize your office workflow

Access to frequently used functions with just one touch (Favorites)

You can preset frequently used functions. Once you register frequently used settings as favorite, you can call up the settings easily. Using this favorite brings the same results even if operated by another person.

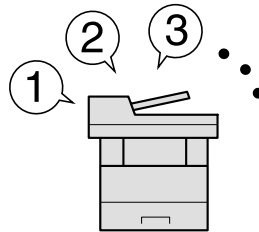

➔ [Recalling Frequently Used Functions \(Favorites\) \(page 230\)](#)

Scan originals of different sizes at a time (Mixed Size Originals)

It is useful when preparing conference materials.

You can set the different sized originals at one time so you don't need to reset the originals regardless of size.

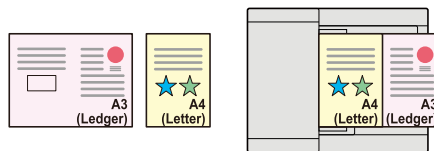

➔ [Mixed Size Originals \(page 325\)](#)

Scan a large number of originals in separate batches and produce as one job (Continuous Scan)

It is useful when preparing many-page handouts.

When a large number of originals cannot be placed in the document processor at one time, the originals can be scanned in separate batches and then copied or sent as one job.

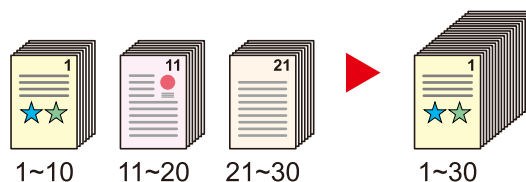

➔ [Continuous Scan \(page 361\)](#)

Send one time with multiple sending options (Multi Sending)

You can send a same document to the multiple destinations using a different method.

You can specify multiple destinations of different send methods such as Email, SMB, and Fax.

You can reduce your workflow by sending a job at once.

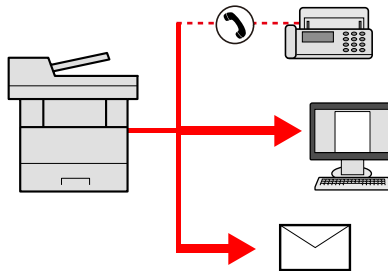

➔ [Sending to different types of destinations \(Multi sending\) \(page 263\)](#)

Save frequently used documents in the machine (Custom Box)

You can save the frequently used document in the machine and print it when needed.

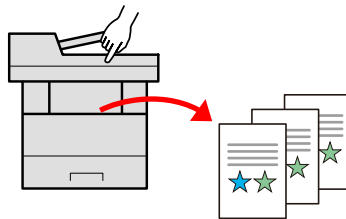

➔ [Using Document Boxes \(page 276\)](#)

Save energy and cost

Save energy as needed (Energy Saver function)

The machine is equipped with Energy Saver function that automatically switches the machine into Sleep Mode. You can set appropriate Energy Saver Recovery Level depending on the operation. In addition, the machine can automatically be switched into Sleep and recovered at a specified time for each day of the week.

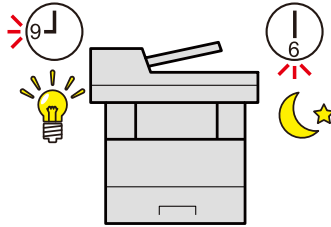

➔ [Energy Saver function \(page 91\)](#)

Printing with reduced toner consumption (EcoPrint)

You can save toner consumption with this function.

When you only need to check the printed content, such as a trial print run or documents for internal confirmation, use this function to save toner.

Use this function when a high-quality print is not required.

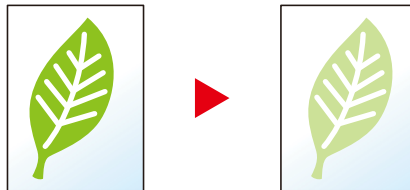

➔ [EcoPrint \(page 336\)](#)

Reduce paper use (Paper Saving Printing)

You can print originals on both sides of the paper. You can also print multiple originals onto one sheet.

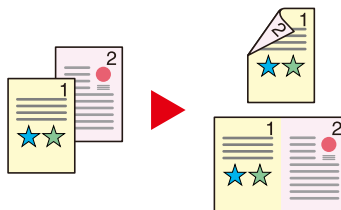

➔ [Combine \(page 349\)](#)

➔ [Duplex \(page 356\)](#)

Skip blank pages when printing (Skip Blank Page)

When there are blank pages in a scanned document, this function skips the blank pages and prints only pages that are not blank.

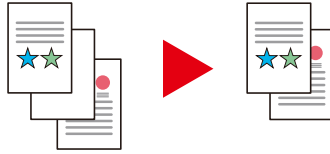

→ [Skip Blank Page \(page 368\)](#)

Create attractive documents

Prevent image bleed-through (Prevent Bleed-through)

You can prevent image bleed-through from the reverse side when scanning thin originals.

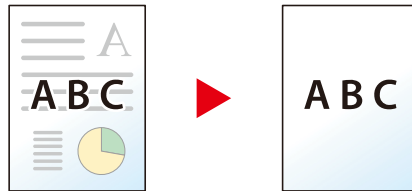

→ [Prevent Bleed-thru \(page 344\)](#)

Strengthen security

Password-protect a PDF file (PDF Encryption Functions)

Use the PDF format's password security options to restrict document viewing, printing and editing.

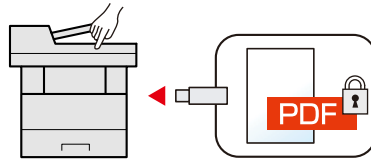

➔ [PDF Encryption Functions \(page 377\)](#)

Protect data on the SSD (Encryption / Overwrite)

You can overwrite the unnecessary data that remains on the SSD automatically.

To prevent an external leakage, the machine is able to encrypt data before writing it to the SSD.

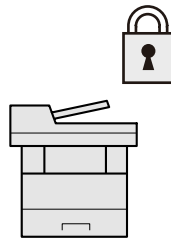

➔ [\[Data Security\] \(page 506\)](#)

Prevent loss of finished documents (Private Print)

Temporarily saving print jobs in the main unit document box and outputting them when in front of the device can prevent documents from being taken by others.

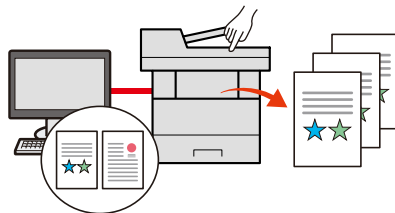

➔ [Printing Documents from Private Print Box \(page 208\)](#)

Log in by ID card (Card Authentication)

You can log in simply by touching an ID card. You don't need to enter your user name and password.

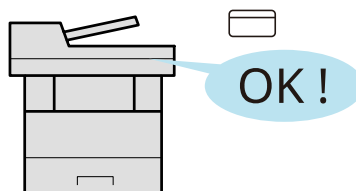

➔ [Card Authentication Kit\(B\) AC <IC card authentication kit \(Activate\)> \(page 744\)](#)

Strengthen security (Settings for Administrator)

Various functions are available for administrators to strengthen security.

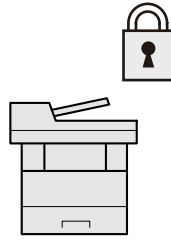

→ [Strengthening the Security \(page 118\)](#)

Prevent the execution of malware (Allowlisting)

Prevent malware from running and prevent software tampering and maintain system reliability.

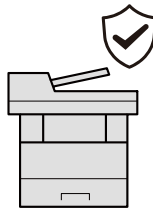

→ [Allowlisting \(page 505\)](#)

Use functions more efficiently

Make the machine quiet (Quiet Mode)

You can make the machine quiet by reducing its running noise. You can configure this mode by job.

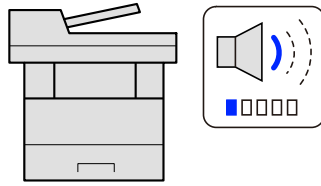

➔ [Quiet Mode \(page 365\)](#)

Expand functions as necessary(Application)

The functionality of the machine can be expanded by installing applications.

Applications that help you perform your daily more efficiently such as a scan feature and an authentication feature are available.

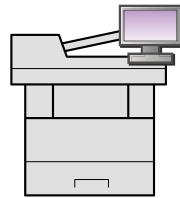

➔ [Using Applications \(page 238\)](#)

Install the machine without concerning the network cables (Wireless Network)

If there is a wireless LAN environment, it is possible to install the unit without worrying about the network wiring. In addition, Wi-Fi Direct, etc. are supported.

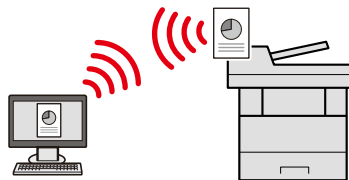

➔ [Configuring the Wireless Network \(page 81\)](#)

Use USB drive(USB Drive)

It is useful when you need to print documents outside your office or you cannot print documents from your PC.

You can print the document from the USB drive by plugging it directly into the machine.

Original scanned at the machine can be saved in the USB drive also.

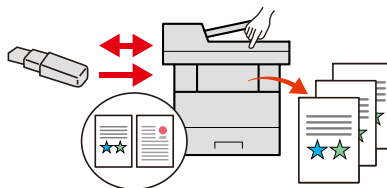

➔ [Using Removable USB Drive \(page 297\)](#)

➔ [Saving Documents to USB Drive \(Scan to USB\) \(page 300\)](#)

Specify image file format (File Format)

You can select the various file formats when sending/storing images.

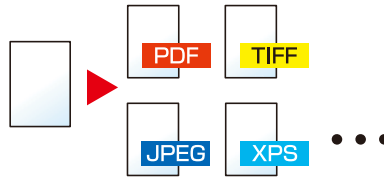

➔ [File format \(page 373\)](#)

Scan the long originals (Long Original)

You can scan the long originals such as Contract and Data log.

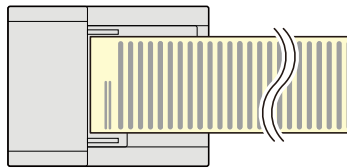

➔ [Long Original \(page 372\)](#)

Detect the multiple feeding of originals (Detect Multi-fed Originals)

When scanning a document from the document processor, scanning is automatically stopped when multiple pages are fed together.

This function is available only for TASKalfa MA4500ci.

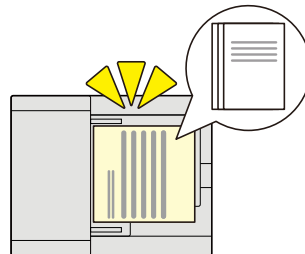

➔ [Detect Multi-fed Originals \(page 366\)](#)

Detect originals with bent corners (Detection of originals with bent corners)

When scanning a document from the document processor, scanning is automatically stopped when a document with a folded corner is detected.



➔ [Detect Folded Corner Orig. \(page 367\)](#)

Perform remote operation (Command Center RX)

You can access to the machine remotely to print, send or download data.

Administrators can configure the machine behavior or management settings.

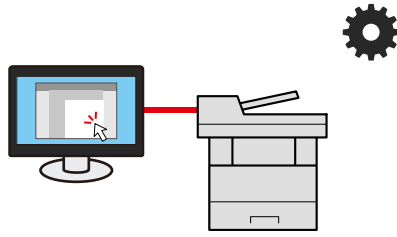

→ [Command Center RX \(page 121\)](#)

Color and Image Quality Functions

The machine is equipped with various color and image quality functions. You can adjust the scanned image as desired.

Basic Color Modes

The basic color modes are as follows.

Auto Color

Automatically recognizes whether a document being scanned is color or black & white.

Reference Image

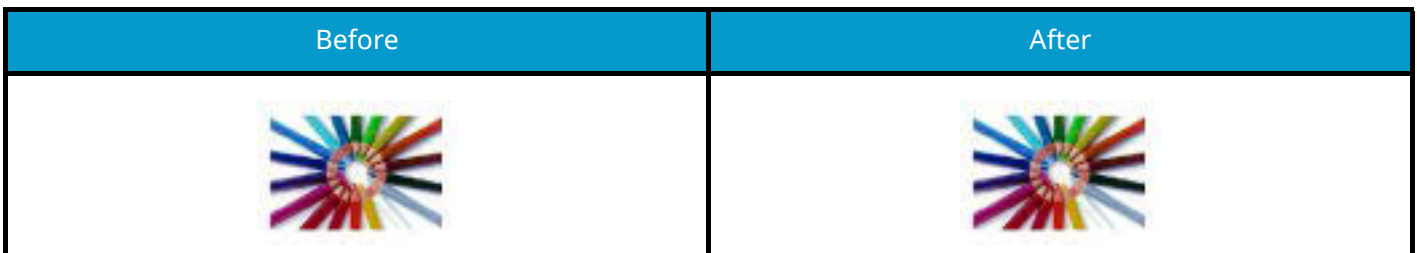

Full Color

Scans the document in full color.

Reference Image

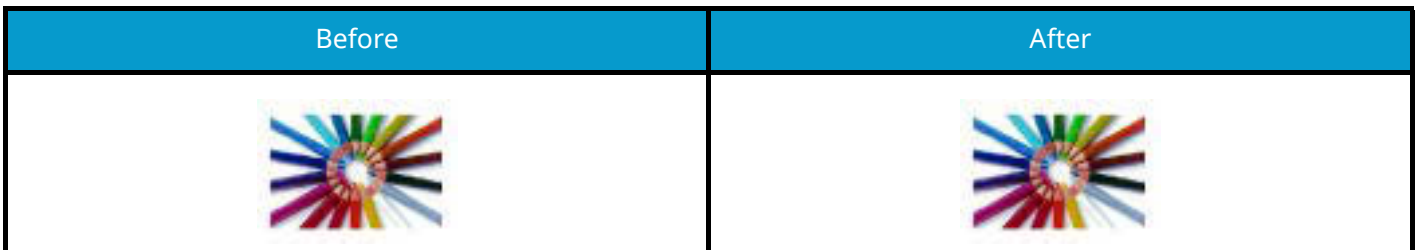

Grayscale

Scans a document in grayscale.

Reference Image

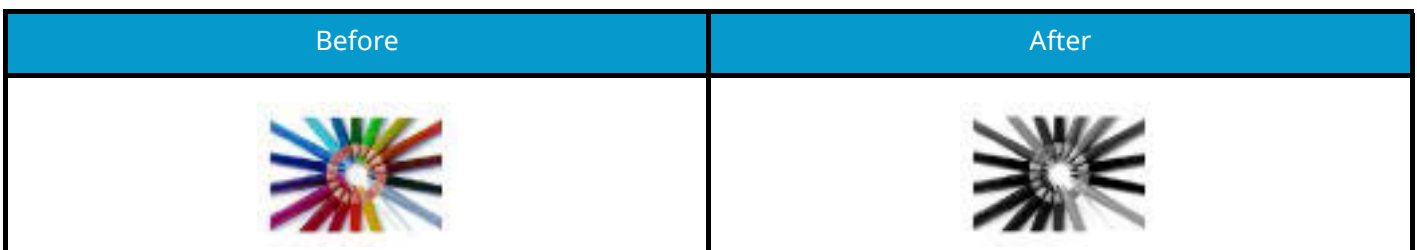

Black & White

Scans the document in black and white.

Reference Image

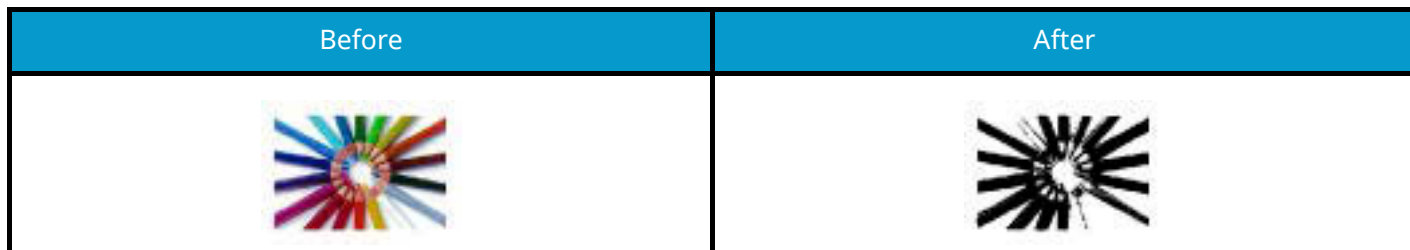









For details, refer to the following.

➔ [Color Selection \(page 337\)](#)

Adjusting Image Quality and Color

To adjust the image quality or color of an image, use the following functions.

Adjust the color precisely







I want to...	Sample image (before)	Sample image (after)	Function
Adjust the density.			Density
Adjust the color by strengthening blue or red tones. Example: Strengthening red			Color Balance
Change the image by individually adjusting each of the six colors: red, blue, green, cyan, magenta, and yellow. Example: Changing red tones close to yellow to yellow, and cyan tones close to blue to blue			Hue Adjustment
Adjust the saturation.			Saturation

For details, refer to the following:

- ➔ [Density \(page 332\)](#)
- ➔ [Color Balance \(page 338\)](#)
- ➔ [Hue Adjustment \(page 339\)](#)
- ➔ [Saturation \(page 343\)](#)

Adjust the image quality precisely



I want to...	Sample image (before)	Sample image (after)	Function
Emphasize or blur the image outline. Example: Emphasize the image outlines			Sharpness

I want to...	Sample image (before)	Sample image (after)	Function
Adjust the difference between dark and light parts of the image.			Contrast
Darken or lighten the background (the area with no texts or images) of a document. Example: Lightening the background			Background Density
Prevent bleed-through in 2-sided originals.			Prevent Bleed through

For details, refer to the following:

- ➔ [Sharpness \(page 341\)](#)
- ➔ [Contrast \(page 345\)](#)
- ➔ [Background Density Adj. \(page 342\)](#)
- ➔ [Prevent Bleed-thru \(page 344\)](#)

Adjust the scanned image

I want to...	Sample image (before)	Sample image (after)	Function
Decrease the file size and produce the characters clearly.			File format [High Comp. PDF]
Convert a paper document to PDF with searchable text.			File format [OCR Text Recognition] of [PDF] or [High Comp. PDF]

For details, refer to the following:

- ➔ [File format \(page 373\)](#)

Guides Provided with the Machine

The following guides are provided with the machine. Refer to each guide as needed. The guides can be downloaded from the Download Center (<https://kyocera.info/>). To view the guides on a computer, Adobe Reader Version 8.0 or later needs to be installed.

The contents of the guides are subject to change without notice for the purpose of improvement of machine performance.

Start using the machine quickly	<p>Quick Guide</p> <p>Describes frequently-used operations and what to do when problems occur.</p> <p>This printed guide is provided together with the machine.</p>
For safe use of the machine	<p>Safety Guide</p> <p>Provides safety and cautionary information for installation environment and use of the machine. Be sure to read this guide before using the machine.</p> <p>This printed guide is provided together with the machine.</p> <p>Safety Guide (TASKalfa MA4500ci/TASKalfa MA3500ci)</p> <p>Indicates the space required for machine installation, and describes the cautionary labels and other safety information. Be sure to read this guide before using the machine.</p> <p>This printed guide is provided together with the machine.</p>
Use the machine to its fullest	<p>Operation Guide (this guide)</p> <p>Explains how to load paper and perform copy, print and scan operations, and indicates default settings and other information.</p>
Use the fax functions	<p>FAX Operation Guide</p> <p>Explains how to use the fax function.</p>
Use the ID card	<p>Card Authentication Kit (B) Operation Guide</p> <p>Explains how to perform authentication using the ID card.</p>
Strengthen security	<p>Data Encryption/Overwrite Operation Guide</p> <p>Explains how to introduce and use the Data Encryption/Overwrite Function, and how to overwrite and encrypt data.</p>
Easily register machine information and configure settings	<p>Command Center RX User Guide</p> <p>Explains how to access the machine from a Web browser on your computer to check and change settings.</p>
Print data from a computer	<p>Printer Driver User Guide</p> <p>Explains how to install the printer driver and use the printer function.</p>
Monitor the machine and printers on the network	<p>KYOCERA Net Viewer User Guide</p> <p>Explains how to monitor your network printing system (the machine) with KYOCERA Net Viewer.</p>
Scan images and save with information	<p>File Management Utility User Guide</p> <p>Explains how to use File Management Utility to set various parameters and send and save scanned documents.</p>

Print without using the printer driver	PRESCRIBE Commands Command Reference Describes the native printer language (PRESCRIBE commands). PRESCRIBE Commands Technical Reference Describes the PRESCRIBE command functions and control for each type of emulation.
Directly print a PDF file	KYOCERA Net Direct Print Operation Guide Explains how to print PDF files without launching Adobe Acrobat or Reader.
Adjust the print or scan position	Maintenance Menu User Guide Maintenance Menu provides the explanation on how to configure the print, scan, and other settings

About the Operation Guide (this Guide)

Structure of the guide

The Operation Guide contains the following chapters.

Chapter	Contents
Please Read First	Provides precautions regarding use of the machine and trademark information.
Installing and Setting up the Machine	Explains part names, cable connections, installation of the software, login, logout, and other matters related to administration of the machine.
Preparation before Use	Explains preparations and settings that are required in order to use the machine, such as how to load paper and create an address book.
Print from PC	Explains the basic printing method.
Operation on the Machine	Explains the basic procedures for using the machine, such as placing originals, making copies, sending documents, and using document boxes.
Using Various Functions	Explains convenient functions that are available on the machine.
Status/Job Cancel	Explains how to check the status of a job and the job history, and how to cancel jobs being printed or waiting to print. Also explains how to check paper and toner levels, how to check the device status, and how to cancel fax transmission.
System Menu	Explains System Menu and how it relates to the operation of the machine.
User Authentication and Accounting (User Login, Job Accounting)	Explains user login and job accounting.
Troubleshooting	Explains what to do when toner runs out, an error is displayed, or a paper jam or other problem occurs.
Appendix	Describes convenient options that are available for the machine. Provides information on media types and paper sizes, and gives a glossary of terms. Explains how to enter characters, and lists the specifications of the machine.

Conventions Used in This Guide

Adobe Reader is used as an example in the explanations below.

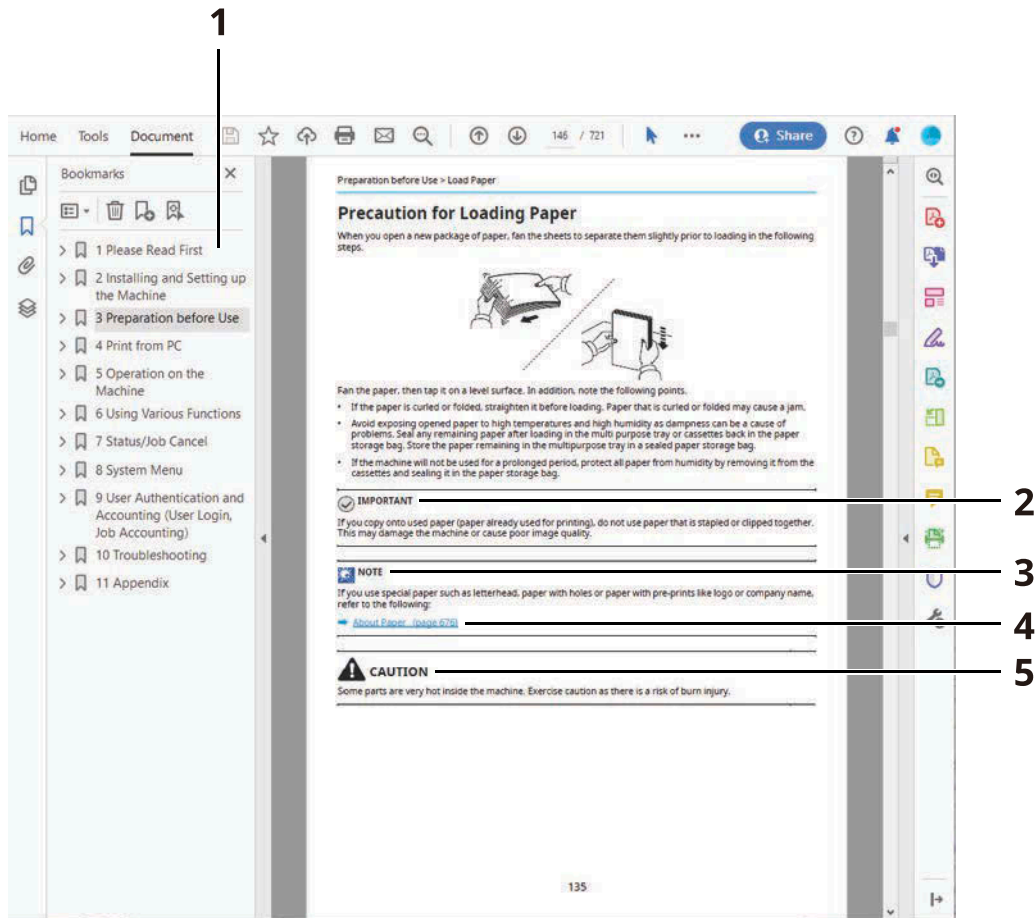

- 1 Click an item in the Table of Contents to jump to the corresponding page.
- 2 Indicates operational requirements and restrictions to operate the machine correctly, and avoid damage to the machine or property.
- 3 Indicates supplemental explanations and reference information for operations.
- 4 Click the underlined text to jump to the corresponding page.
- 5 Indicates that personal injury or mechanical damage may result from insufficient attention to or incorrect compliance with the related points.

NOTE

The items that appear in Adobe Reader vary depending on how it is used. If the Table of Contents or tools do not appear, refer to Adobe Reader Help.

Certain items are indicated in this guide by the conventions described below.

Convention	Description
[]	Indicates keys and buttons.
" "	Indicates a message.

Conventions Used in Procedures for Operating the Machine

In this Operation Guide, continuous operation of the keys on the touch panel is as follows:

Actual procedure

- 1 Press the [System Menu / Counter] key.
- 2 Select [DeviceSettings].
- 3 Move the screen downwards (i.e. swiping)
- 4 Select [Sound].

Procedure indicated in this guide

[System Menu / Counter] key > [DeviceSettings] > [Sound]

Actual procedure

- 1 Select [Job Accounting/Authentication].

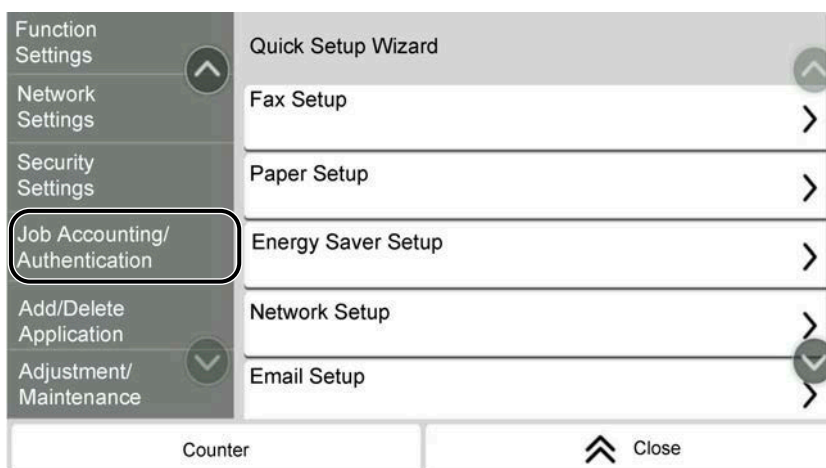

- 2 Select [Job Accounting] from "Job Accounting Setting".

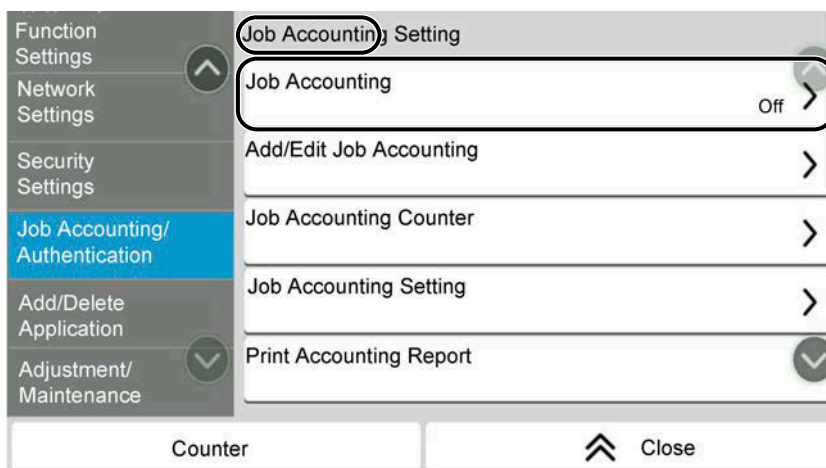

Procedure indicated in this guide

[Job Accounting/Authentication] > "Job Accounting Setting" [Job Accounting]

For details on touch panel operation, refer to the following:



➔ [Using the Touch Panel \(page 56\)](#)

Size of Paper

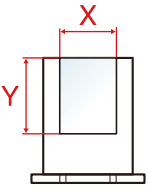

Paper sizes such as A5 and Statement can be used in both the horizontal and vertical orientations. To distinguish the orientations when these sizes are used, "R" is added to sizes used in the horizontal orientation.

Set the paper in vertical orientation

When loading in a cassette

Setting Position (X=Length, Y=Width)	Icon on the touch panel	Indicated size in this Guide
		A5-R, Statement-R

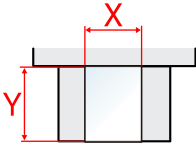
When loading in the multipurpose tray



Setting Position (X=Length, Y=Width)	Icon on the touch panel	Indicated size in this Guide
		A5-R, Statement-R

Paper sizes that can be used vary depending on the function and paper feeder unit. For details, refer to the following.

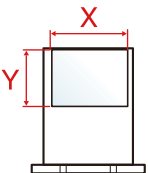

➔ [Specifications \(page 760\)](#)

Set the paper in horizontal orientation

When loading in a cassette

Setting Position (X=Length, Y=Width)	Icon on the touch panel	Indicated size in this Guide
		A5, Statement

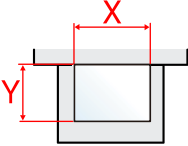
When loading in the multipurpose tray

Setting Position (X=Length, Y=Width)	Icon on the touch panel	Indicated size in this Guide
		A5, Statement

Paper sizes that can be used vary depending on the function and paper feeder unit. For details, refer to the following.

➔ [Specifications \(page 760\)](#)

Notice

Safety Conventions in This Guide

The sections of this guide and parts of the machine marked with symbols are safety warnings meant to protect the user, other individuals and surrounding objects, and ensure correct and safe usage of the machine. The symbols and their meanings are indicated below.



WARNING:

Indicates that serious injury or even death may result from insufficient attention to or incorrect compliance with the related points.



CAUTION:

Indicates that personal injury or mechanical damage may result from insufficient attention to or incorrect compliance with the related points.

Symbols

The  symbol indicates that the related section includes safety warnings. Specific points of attention are indicated inside the symbol.



[General warning]



[Warning of high temperature]

The  symbol indicates that the related section includes information on prohibited actions. Specifics of the prohibited action are indicated inside the symbol.



[Warning of prohibited action]



[Disassembly prohibited]

The  symbol indicates that the related section includes information on actions which must be performed. Specifics of the required action are indicated inside the symbol.



[Alert of required action]



[Remove the power plug from the outlet]



[Always connect the machine to an outlet with a ground connection]



NOTE

An original which resembles a bank note closely may not be copied properly in some rare cases because this machine is equipped with a counterfeiting prevention function.

Environment

The service environmental conditions are as follows:

Temperature	10 to 32.5°C/50 to 90.5°F But humidity should be 70% or less when temperature is 90.5 °F (32.5 °C).
Humidity	10 to 80% But temperature should be 86 °F (30 °C) or less when humidity is 80%.

Avoid the following locations when selecting a site for the machine.

- Avoid locations near a window or with exposure to direct sunlight.
- Avoid locations with vibrations.
- Avoid locations with drastic temperature fluctuations.
- Avoid locations with direct exposure to hot or cold air.
- Avoid poorly ventilated locations.

During copying, some ozone is released, but the amount does not cause any ill effect to one's health.

If, however, the machine is used over a long period of time in a poorly ventilated room or when making an extremely large number of copies, the smell may become unpleasant.

To maintain the appropriate environment for copy work, it is suggested that the room be properly ventilated.

Precautions for Use

Cautions when handling consumables

CAUTION

Do not attempt to incinerate parts which contain toner. Dangerous sparks may cause burns.

Keep parts which contain toner out of the reach of children.

If toner happens to spill from parts which contain toner, avoid inhalation and ingestion, as well as contact with your eyes and skin.

- If you do happen to inhale toner, move to a place with fresh air and gargle thoroughly with a large amount of water. If coughing develops, contact a physician.
- If you do happen to ingest toner, rinse your mouth with water and drink 1 or 2 cups of water to dilute the contents of your stomach. If necessary, contact a physician.
- If you do happen to get toner in your eyes, flush them thoroughly with water. If there is any remaining tenderness, contact a physician.
- If toner does happen to get on your skin, wash with soap and water.

Do not attempt to force open or destroy parts which contain toner.

Other precautions

Return the exhausted toner container and waste toner box to your dealer or service representative. The collected toner container and waste toner box will be recycled or disposed in accordance with the relevant regulations.

Store the machine while avoiding exposure to direct sunlight.

Store the machine in a place where the temperature stays below 40 °C while avoiding sharp changes of temperature and humidity.

If the machine will not be used for an extended period of time, remove the paper from the cassette and the Multipurpose (MP) Tray, return it to its original package and reseal it.

SAFETY OF LASER BEAM (USA)

Safety of laser beam

This machine has been certified by the manufacturer to Class 1 level under the radiation performance standards established by the U.S.DHHS (Department of Health and Human Services) in 1968. This indicates that the product is safe to use during normal operation and maintenance. The laser optical system, enclosed in a protective housing and sealed within the external covers, never permits the laser beam to escape.

The CDRH Act

A laser-product-related act was implemented on Aug. 2, 1976, by the Center for Devices and Radiological Health (CDRH) of the U.S. Food and Drug Administration (FDA). This act prohibits the sale of laser products in the U.S. without certification, and applies to laser products manufactured after Aug. 1, 1976. The label shown below indicates compliance with the CDRH regulations and must be attached to laser products marketed in the United States.

The position of the rating label is show below.

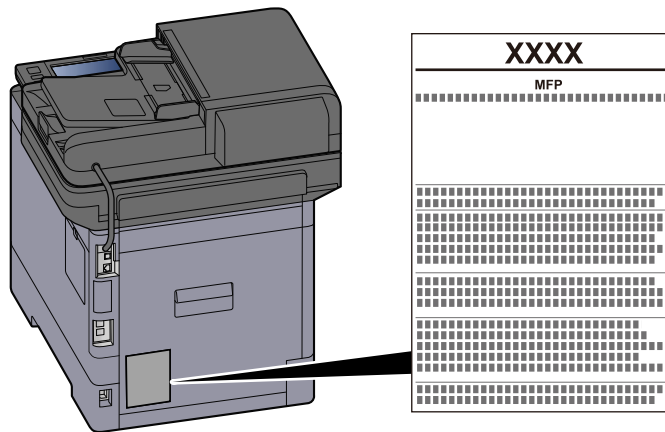

Optical unit

When checking the optical unit, avoid direct exposure to the laser beam, which is invisible. Shown at below is the label located on the cover of the optical unit.

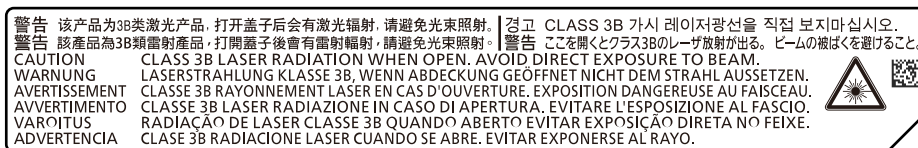

Maintenance

For safety of the service personnel, follow the maintenance instructions in the other section of this manual.

Safety Instructions Regarding the Disconnection of Power

Caution: The power plug is the main isolation device! Other switches on the equipment are only functional switches and are not suitable for isolating the equipment from the power source.

Attention: Le débranchement de la fiche secteur est le seul moyen de mettre l'appareil hors tension. Les interrupteurs sur l'appareil ne sont que des interrupteurs de fonctionnement: ils ne mettent pas l'appareil hors tension.

Compliance and Conformity

We hereby declare that this product complies with Directive 2014/53/EU.

The full text of the EU declaration of conformity is available at the following internet address:

<https://www.kyoceradocumentsolutions.eu/index/service/dlc.html>

Module name, Option	Software Ver.	Frequency band in which the radio equipment operates:	Maximum radio-frequency power transmitted in the frequency band in which the radio equipment operates:
IB-51 (option)	2.2.6	2.4 GHz	100 mW
IB-37 (option)	1.0	2.4 GHz	100 mW
		5 GHz	50 mW - 1 W
IB-38 (option)	1.0	2.4 GHz	100 mW

This equipment has been tested and found to comply with the limits for a Class B digital device, pursuant to Part 15 of the FCC Rules.

These limits are designed to provide reasonable protection against harmful interference in a residential installation. This equipment generates, uses and can radiate radio frequency energy and, if not installed and used in accordance with the instructions, may cause harmful interference to radio communications. However, there is no guarantee that interference will not occur in a particular installation. If this equipment does cause harmful interference to radio or television reception, which can be determined by turning the equipment off and on, the user is encouraged to try to correct the interference by one or more of the following measures:

- Reorient or relocate the receiving antenna.
- Increase the separation between the equipment and receiver.
- Connect the equipment into an outlet on a circuit different from that to which the receiver is connected.
- Consult the dealer or an experienced radio/TV technician for help.
- The use of a non-shielded interface cable with the referenced device is prohibited.

FCC Caution: Any changes or modifications not expressly approved by the party responsible for compliance could void the user's authority to operate this equipment.

This device complies with Part 15 of FCC Rules.

Operation is subject to the following two conditions; (1) this device may not cause harmful interference, and (2) this device must accept any interference received, including interference that may cause undesired operation.

IMPORTANT NOTE:

Radiation Exposure Statement:

This equipment complies with FCC radiation exposure limits set forth for an uncontrolled environment. This equipment should be installed and operated with minimum distance 20 cm between the radiator & your body.

Industry Canada statement:

This device contains licence-exempt transmitter(s) / receiver(s) that complies with Innovation, Science and Economic Development Canada's licence-exempt RSS (s). Operation is subject to the following two conditions:

- 1 This device may not cause interference.
- 2 This device must accept any interference, including interference that may cause undesired operation of the device.

The antenna(s) used for this transmitter must be installed to provide a separation distance of at least 20 cm from all persons and must not be co-located or operating in conjunction with any other transmitter.

Industry Canada ICES-003 Compliance Label: CAN ICES-3B/NMB-3B

* The above statements are valid only in the United States of America and Canada.

NOTE — Use shielded interface cables.

Caution:

The device for operation in the band 5150-5250 MHz is only for indoor use to reduce the potential for harmful interference to co-channel mobile satellite systems;

Operations in the 5.25-5.35GHz band are restricted to indoor usage only.

Radiation Exposure Statement:

This equipment complies with Canada radiation exposure limits set forth for an uncontrolled environment. This equipment should be installed and operated with minimum distance 20cm between the radiator & your body. * These above statements are valid in the United States of America, Canada and EU.

Radio Tag Technology

In some countries the radio tag technology used in this equipment to identify the toner container may be subject to authorization and the use of this equipment may consequently be restricted.

Other precautions (for users in California, the United States)

Perchlorate Material - special handling may apply. See www.dtsc.ca.gov/hazardouswaste/perchlorate.

Warranty (the United States and Canada)

MA4500ci COLOR MULTIFUNCTIONAL PRODUCT LIMITED WARRANTY

KYOCERA Document Solutions America, Inc. and KYOCERA Document Solutions Canada, Ltd. (both referred to as "KYOCERA") warrant the Customer's new color Multifunctional Product (referred to as "MFP"), and the new accessories installed with the initial installation of the MFP, against any defects in material and workmanship for a period of one year, or 300,000 copies/prints from date of installation, whichever first occurs. In the event the MFP or an accessory is found to be defective within the warranty period, KYOCERA's only obligation and the Customer's exclusive remedy shall be replacement of any defective parts. KYOCERA shall have no obligation to furnish labor.

This warranty is valid only for the original retail purchaser (referred to as the "Customer") of a new KYOCERA MFP in the United States of America or Canada, based upon the country of purchase.

In order to obtain performance of this warranty, the Customer must immediately notify the Authorized KYOCERA Dealer from whom the product was purchased. If the KYOCERA Dealer is not able to provide service, write to KYOCERA at the address below for the name and address of the Authorized KYOCERA Dealer in your area, or check KYOCERA's website at <https://www.kyoceradocumentsolutions.com> for KYOCERA Document Solutions America, Inc. or <https://www.kyoceradocumentsolutions.ca> for KYOCERA Document Solutions Canada, Ltd.

This warranty does not cover MFPs or accessories which: (a) have become damaged due to operator negligence, misuse, accidents, improper storage or unusual physical or electrical stress, (b) have used parts or supplies which are not genuine KYOCERA brand parts or supplies, (c) have been installed or serviced by a technician not employed by KYOCERA or an Authorized KYOCERA Dealer, or (d) have had the serial number modified, altered, or removed.

This warranty gives the Customer specific legal rights. The Customer may also have other rights, which vary from state to state, or province to province. Neither the seller, nor any other person, is authorized to extend the time period or expand this warranty on behalf of KYOCERA.

THIS WARRANTY IS MADE IN LIEU OF ALL OTHER WARRANTIES AND CONDITIONS, EXPRESS OR IMPLIED, AND KYOCERA SPECIFICALLY DISCLAIMS ANY IMPLIED WARRANTY OR CONDITION OF MERCHANTABILITY OR FITNESS FOR A PARTICULAR PURPOSE. THIS WARRANTY SHALL NOT EXTEND TO, AND KYOCERA SHALL NOT BE LIABLE FOR, ANY INCIDENTAL OR CONSEQUENTIAL DAMAGES WHICH MAY ARISE OUT OF THE USE OF, OR INABILITY TO USE, THE MFP.

KYOCERA Document Solutions America, Inc.

225 Sand Road, P.O. Box 40008
Fairfield, New Jersey 07004-0008, USA

KYOCERA Document Solutions Canada, Ltd.

6120 Kestrel Rd., Mississauga, ON L5T 1S8,
Canada

Legal Restriction on Copying/Scanning

It may be prohibited to copy/scan copyrighted material without permission of the copyright owner.

Copying/Scanning the following items is prohibited and may be penalized by law. It may not be limited to these items. Do not knowingly copy/scan the items that are not to be copied/scanned.

- Paper money
- Bank note
- Securities
- Stamp
- Passport
- Certificate

Local laws and regulations may prohibit or restrict copying/scanning of other items not mentioned above.

Wireless Connection (Mexico only)

The operation of this equipment is subject to the following two conditions:

(1) it is possible that this equipment or device may not cause harmful interference, and (2) this equipment or device must accept any interference, including interference that may cause undesired operation.

La operación de este equipo está sujeta a las siguientes dos condiciones:

(1) es posible que este equipo o dispositivo no cause interferencia perjudicial y (2) este equipo o dispositivo debe aceptar cualquier interferencia, incluyendo la que pueda causar su operación no deseada.

Security Precautions when Using Wireless LAN (If equipped)

Wireless LAN allows information to be exchanged between wireless access points instead of using a network cable, which offers the advantage that a WLAN connection can be established freely within an area in which radio waves can be transmitted.

On the other hand, the following problems may occur if security settings are not configured, because radio waves can pass through obstacles (including walls) and reach everywhere within a certain area.

Secretly Viewing Communication Contents

A third person with malicious objectives may intentionally monitor radio waves and gain unauthorized access to the following communication contents.

- Personal information including ID, passwords, and credit card numbers
- Contents of email messages

Illegal Intrusion

A third party with malicious intent may gain unauthorized access to personal or company networks and conduct the following illegal actions.

- Extracting personal and confidential information (information leak)
- Entering into communication while impersonating a specific person and distributing unauthorized information (spoofing)
- Modifying and retransmitting intercepted communications (falsification)
- Transmitting computer viruses and destroying data and systems (destruction)

Wireless LAN cards and wireless access points contain built-in security mechanisms to address these problems and to reduce the possibility of these problems occurring by configuring the security settings of wireless LAN products when the product is used.

We recommend that customers take responsibility and use their judgment when configuring the security settings and that they ensure that they fully understand the problems that can occur when the product is used without configuring the security settings.

Limited Use of This Product (If equipped)

- Radio waves transmitted from this product may affect medical equipment. When using this product in a medical institution or in the vicinity of medical instruments, either use this product according to the instructions and precautions provided by the administrator of the institution or those provided on the medical instruments.
- Radio waves transmitted from this product may affect automatic control equipment including automatic doors and fire alarms. When using this product in the vicinity of the automatic control equipment, use this product according to the instructions and precautions provided on the automatic control equipment.
- If this product is used in devices that are directly related to service including airplanes, trains, ships, and automobiles or this product is used in applications requiring high reliability and safety to function and in devices requiring accuracy including those used in disaster prevention and crime prevention and those used for various safety purposes, please use this product after considering the safety design of the entire system including adoption of a failsafe design and redundancy design for reliability and safety maintenance of the entire system. This product is not intended for use in applications requiring high reliability and safety including aerospace instruments, trunk communication equipment, nuclear power control equipment, and medical equipment; hence, the decision as to whether to use this product in these applications needs to be fully considered and determined.

Legal and Safety Information

Unauthorized reproduction (copying) of all or part of this document is prohibited, with the exception of copyright law exceptions.

Regarding Trade Names

- PRESCRIBE is registered trademark of Kyocera Corporation.
- KPDL is a trademark of Kyocera Corporation.
- TASKalfa is registered trademarks or trademarks of KYOCERA Document Solutions Inc.
- Active Directory, Azure, Excel, Microsoft, Microsoft 365, Microsoft Edge, PowerPoint, Windows and Windows Server are registered trademarks or trademarks of Microsoft Corporation in the U.S.A. and/or other countries.
- PCL is a trademark of Hewlett-Packard Company.
- Adobe, Acrobat, PostScript and Reader are registered trademarks or trademarks of Adobe Inc. in the U.S.A. and/or other countries.
- Ethernet is a registered trademark of Fuji Xerox Co., Ltd.
- IBM and IBM PC/AT are trademarks of International Business Machines Corporation.
- AppleTalk, Bonjour, Mac, and Mac OS are trademarks of Apple Inc., registered in the U.S. and other countries.
- All European language fonts installed in this machine are used under licensing agreement with Monotype Imaging Inc.
- Helvetica, Palatino and Times are registered trademarks of Linotype GmbH.
- ITC Avant Garde Gothic, ITC Bookman, ITC ZapfChancery and ITC ZapfDingbats are registered trademarks of International Typeface Corporation.
- ThinPrint is a trademark of Cortado AG in Germany and other countries.
- UFST™ MicroType® fonts by Monotype Imaging Inc. are installed in this machine.
- iPad, iPhone and iPod touch are trademarks of Apple Inc., registered in the U.S. and other countries.
- AirPrint and the AirPrint logo are trademarks of Apple Inc.
- iOS is a trademark or registered trademark of Cisco in the U.S. and other countries and is used under license by Apple Inc.
- Google is trademarks and/or registered trademarks of Google LLC.
- Mopria™ is registered trademarks of Mopria™ Alliance.
- Wi-Fi, Wi-Fi Direct and Wi-Fi Protected Setup are trademarks and/or registered trademarks of Wi-Fi Alliance.
- RealVNC, VNC and RFB are registered trademarks of RealVNC Ltd. in the U.S. and in other countries.

All other brands and product names are registered trademarks or trademarks of their respective companies. Neither™ nor® will be specified in the main text.

Monotype Imaging License Agreement

- 1 Software shall mean the digitally encoded, machine readable, scalable outline data as encoded in a special format as well as the UFST Software.
- 2 You agree to accept a non-exclusive license to use the Software to reproduce and display weights, styles and versions of letters, numerals, characters and symbols (Typefaces) solely for your own customary business or personal purposes at the address stated on the registration card you return to Monotype Imaging. Under the terms of this License Agreement, you have the right to use the Fonts on up to three printers. If you need to have access to the fonts on more than three printers, you need to acquire a multiuser license agreement which can be obtained from Monotype Imaging. Monotype Imaging retains all rights, title and interest to the Software and Typefaces and no rights are granted to you other than a License to use the Software on the terms expressly set forth in this Agreement.

- 3 To protect proprietary rights of Monotype Imaging, you agree to maintain the Software and other proprietary information concerning the Typefaces in strict confidence and to establish reasonable procedures regulating access to and use of the Software and Typefaces.
- 4 You agree not to duplicate or copy the Software or Typefaces, except that you may make one backup copy. You agree that any such copy shall contain the same proprietary notices as those appearing on the original.
- 5 This License shall continue until the last use of the Software and Typefaces, unless sooner terminated. This License may be terminated by Monotype Imaging if you fail to comply with the terms of this License and such failure is not remedied within thirty (30) days after notice from Monotype Imaging. When this License expires or is terminated, you shall either return to Monotype Imaging or destroy all copies of the Software and Typefaces and documentation as requested.
- 6 You agree that you will not modify, alter, disassemble, decrypt, reverse engineer or decompile the Software.
- 7 Monotype Imaging warrants that for ninety (90) days after delivery, the Software will perform in accordance with Monotype Imaging-published specifications, and the diskette will be free from defects in material and workmanship. Monotype Imaging does not warrant that the Software is free from all bugs, errors and omissions.

The parties agree that all other warranties, expressed or implied, including warranties of fitness for a particular purpose and merchantability, are excluded.
- 8 Your exclusive remedy and the sole liability of Monotype Imaging in connection with the Software and Typefaces is repair or replacement of defective parts, upon their return to Monotype Imaging.

In no event will Monotype Imaging be liable for lost profits, lost data, or any other incidental or consequential damages, or any damages caused by abuse or misapplication of the Software and Typefaces.
- 9 Massachusetts U.S.A. law governs this Agreement.
- 10 You shall not sublicense, sell, lease, or otherwise transfer the Software and/or Typefaces without the prior written consent of Monotype Imaging.
- 11 Use, duplication or disclosure by the Government is subject to restrictions as set forth in the Rights in Technical Data and Computer Software clause at FAR 252-227-7013, subdivision (b)(3)(ii) or subparagraph (c)(1)(ii), as appropriate. Further use, duplication or disclosure is subject to restrictions applicable to restricted rights software as set forth in FAR 52.227-19 (c)(2).
- 12 You acknowledge that you have read this Agreement, understand it, and agree to be bound by its terms and conditions. Neither party shall be bound by any statement or representation not contained in this Agreement. No change in this Agreement is effective unless written and signed by properly authorized representatives of each party. By opening this diskette package, you agree to accept the terms and conditions of this Agreement.

OpenSSL License

For the Open Source Software license, go into the following URL and select Country > Product Name > OS > Language and then, refer to the "OSS_Notice" from the manual tab in the Download.

<https://kyocera.info/>

Energy Saving Control Function

To reduce power consumption when idle, the device comes equipped with a power management function that automatically shifts to "Sleep" to minimize power consumption after a certain period of time has passed since the device was last used.

→ [Sleep \(page 91\)](#)

Automatic 2-Sided Print Function

This device includes 2-sided printing as a standard function. For example, by printing two 1-sided originals onto a single sheet of paper as a 2-sided print, it is possible to lower the amount of paper used.

→ [Duplex \(page 356\)](#)

Printing in duplex mode reduces paper consumption and contributes to the conservation of forest resources. Duplex mode also reduces the amount of paper that must be purchased, and thereby reduces cost. It is recommended that machines capable of duplex printing be set to use duplex mode by default.

Resource Saving - Paper

For the preservation and sustainable use of forest resources, it is recommended that recycled as well as virgin paper certified under environmental stewardship initiatives or carrying recognized ecolabels, which meet EN 12281:2002* or an equivalent quality standard, be used.

This machine also supports printing on 64 g/m² paper. Using such paper containing less raw materials can lead to further saving of forest resources.

* : EN12281:2002 "Printing and business paper - Requirements for copy paper for dry toner imaging processes"

Contact your dealer or service representative for recommended paper types.

Environmental benefits of "Power Management"

To reduce power consumption when idle, this machine is equipped with a power management function that automatically activates energy-saving mode when the machine is idle for a certain period of time.

Although it takes the machine a slight amount of time to return to READY mode when in energy-saving mode, a significant reduction in energy consumption is possible. It is recommended that the machine be used with the activation time for energy-saving mode set to the default setting.

ENERGY STAR Program



We participate in the ENERGY STAR[®] Program. We provide the products that comply with ENERGY STAR standards to the market.

ENERGY STAR is an energy efficiency program with the goal of developing and promoting the use of products with high energy efficiency in order to help prevent global warming. By purchasing the products that comply with ENERGY STAR, customers can help reduce emissions of greenhouse gases during product use and cut energy-related costs.

2 Installing and Setting up the Machine

Part Names (Machine Exterior)

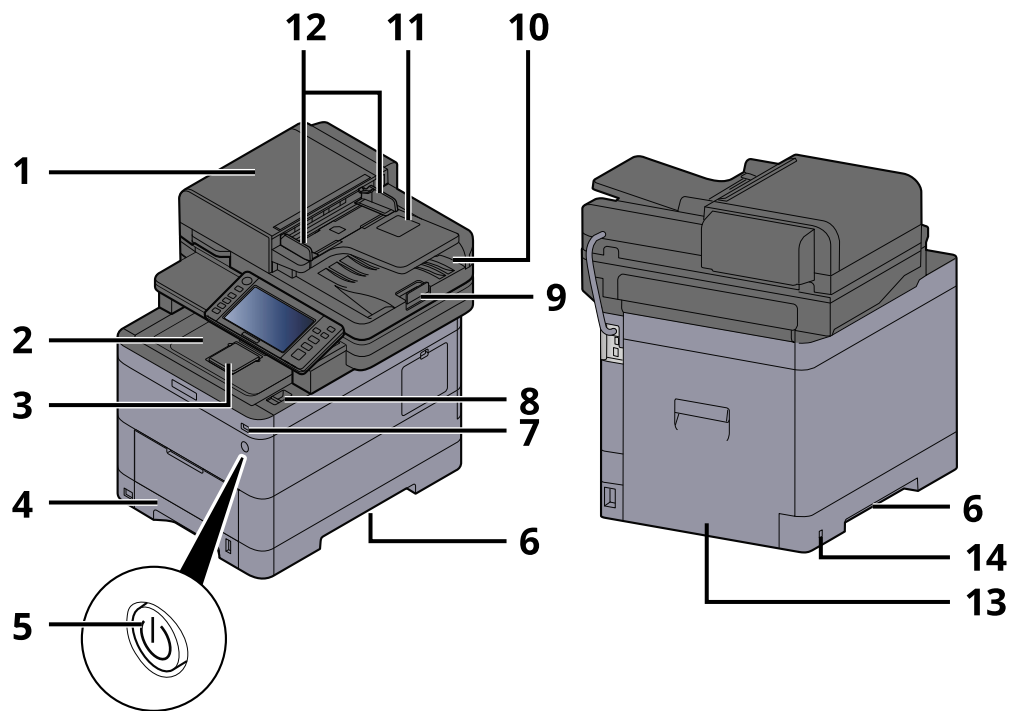

- 1 Document processor
- 2 Inner tray
- 3 Eject stopper
- 4 Cassette 1
- 5 Power Switch
- 6 Conveying handle
- 7 USB Memory slot
- 8 Scanner unit open lever
- 9 Original stopper
- 10 Original eject table
- 11 Original tray
- 12 Original width guide
- 13 Rear cover 1
- 14 Anti-theft slot

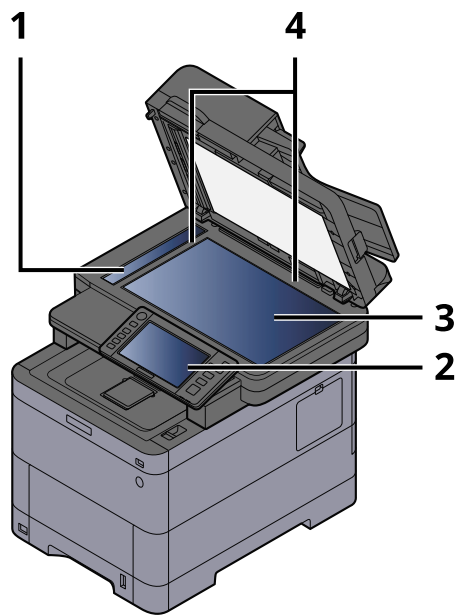

- 1 Slit glass
- 2 Operation panel
- 3 Platen
- 4 Original size indicator plate

Part Names (Connectors/Interior)

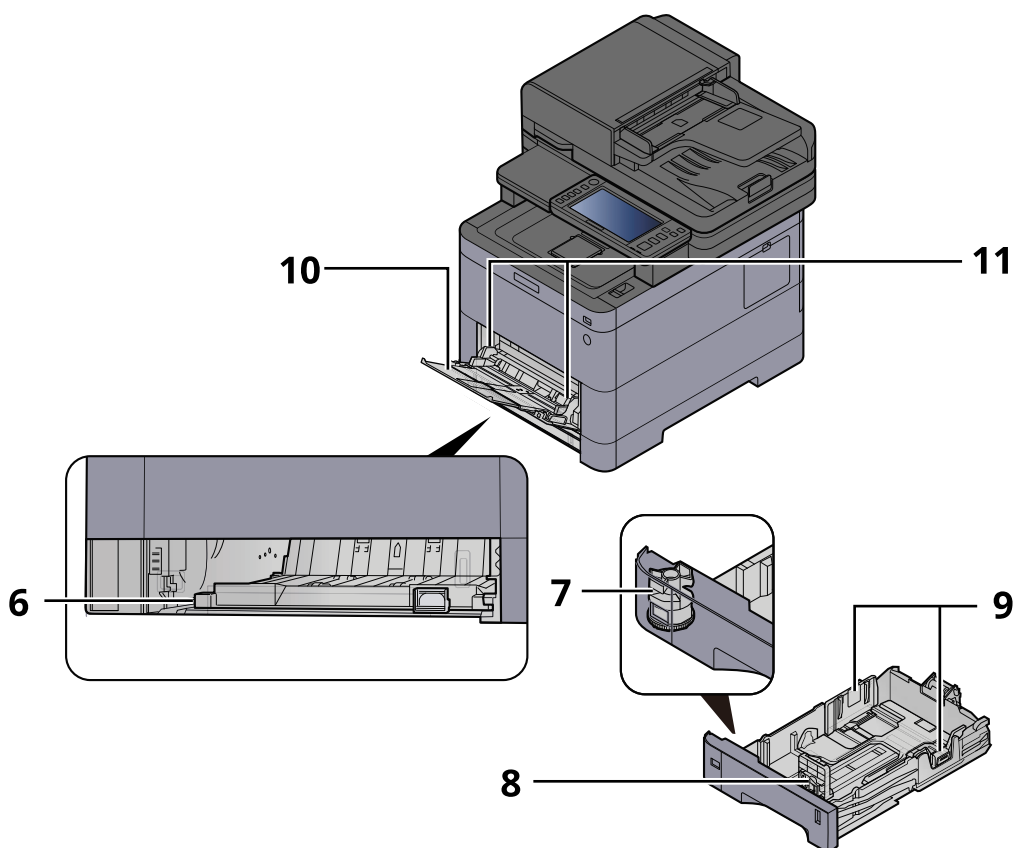
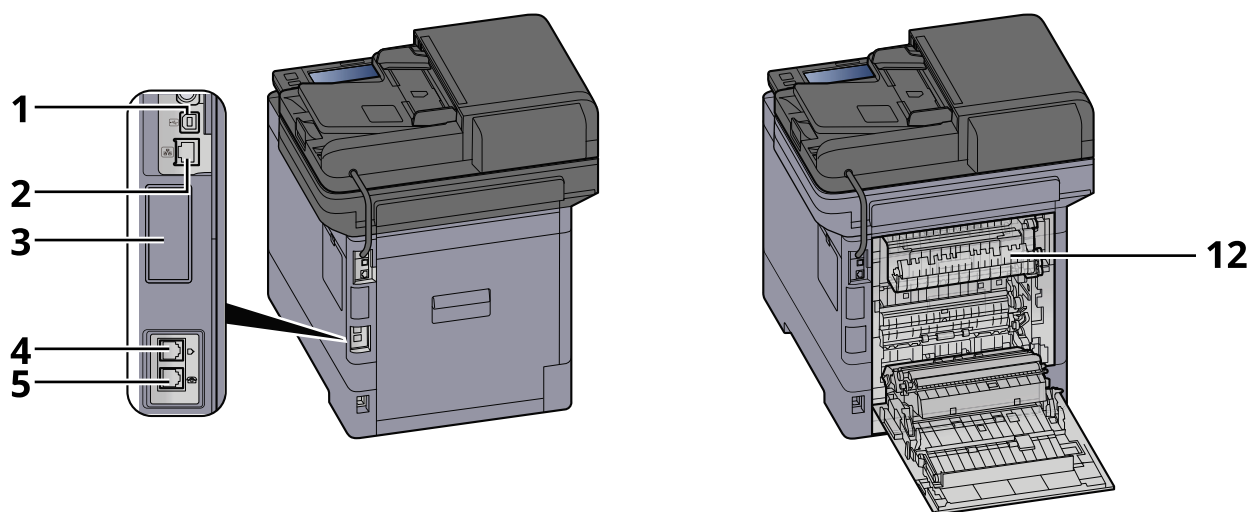

- 1 USB interface connector
- 2 Network interface connector
- 3 Optional interface slot
- 4 LINE connector
- 5 TEL connector

- 6 Conveying cover
- 7 Size dial
- 8 Paper length guide
- 9 Paper width guide
- 10 Paper guide
- 11 Multipurpose Tray
- 12 Fuser cover

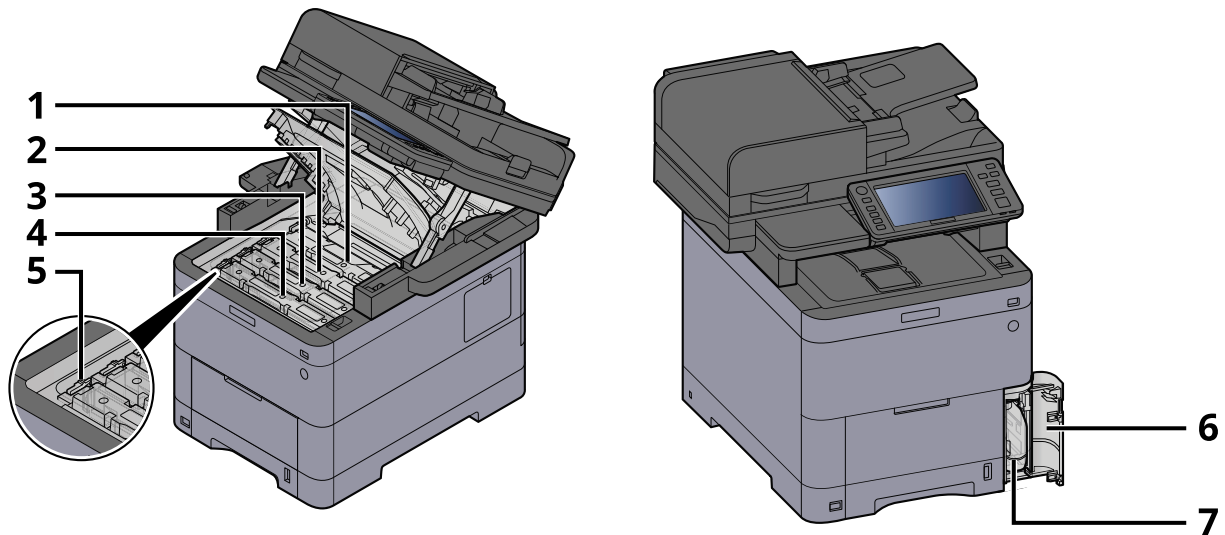

- 1 Toner container (Black)
- 2 Toner container (Cyan)
- 3 Toner container (Magenta)
- 4 Toner container (Yellow)
- 5 Toner container lock lever
- 6 Waste toner cover
- 7 Waste toner box

Part Names (With Optional Equipments Attached)

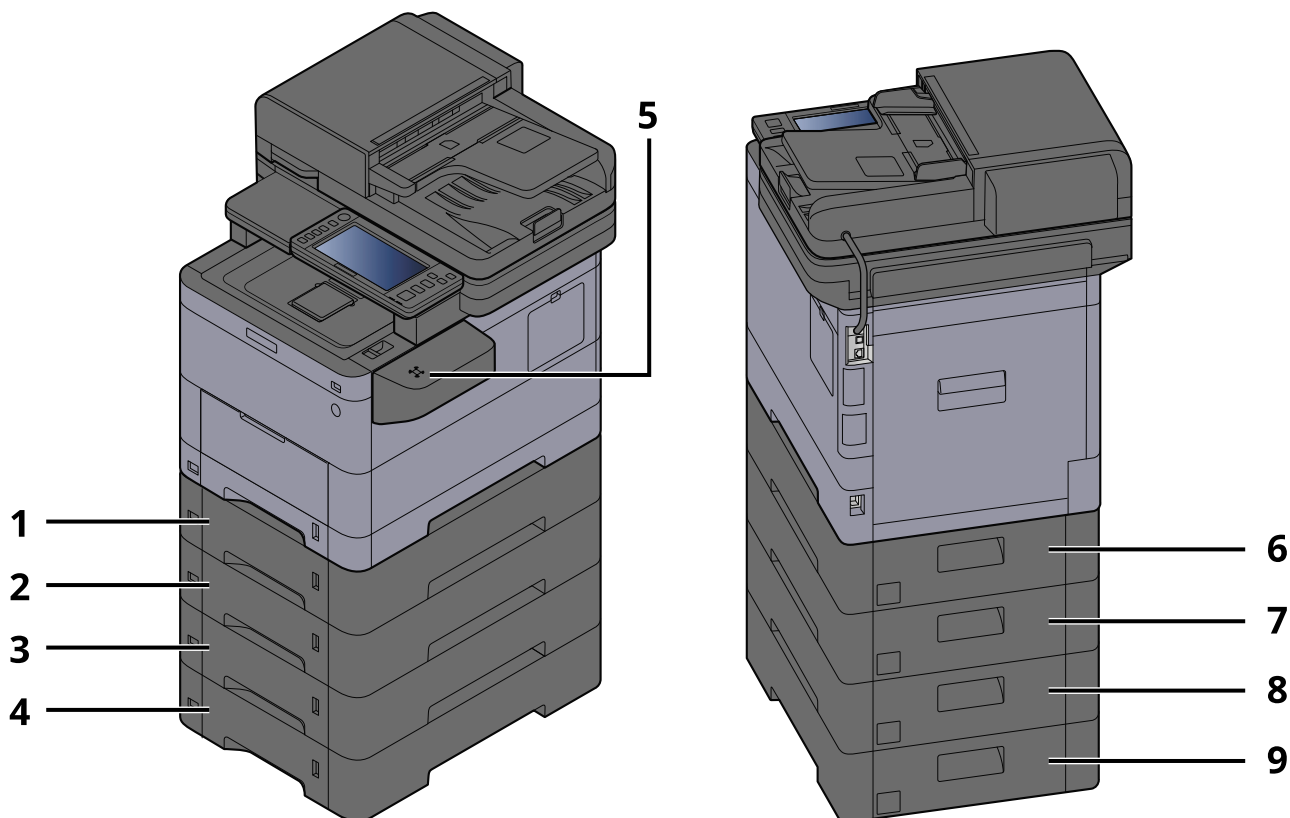

- 1 Cassette 2
- 2 Cassette 3
- 3 Cassette 4
- 4 Cassette 5
- 5 Card reader
- 6 Rear cover 2
- 7 Rear cover 3
- 8 Rear cover 4
- 9 Rear cover 5

For details of options, refer to the following:

➔ [Overview of Optional Equipment \(page 742\)](#)

Connecting the Machine and Other Devices

Prepare the cables necessary to suit the environment and purpose of the machine use.

When Connecting the Machine to the PC via USB

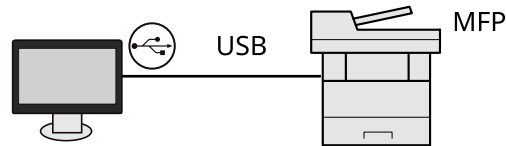

When Connecting the Machine to the PC or Tablet by network cable, Wi-Fi, or Wi-Fi direct

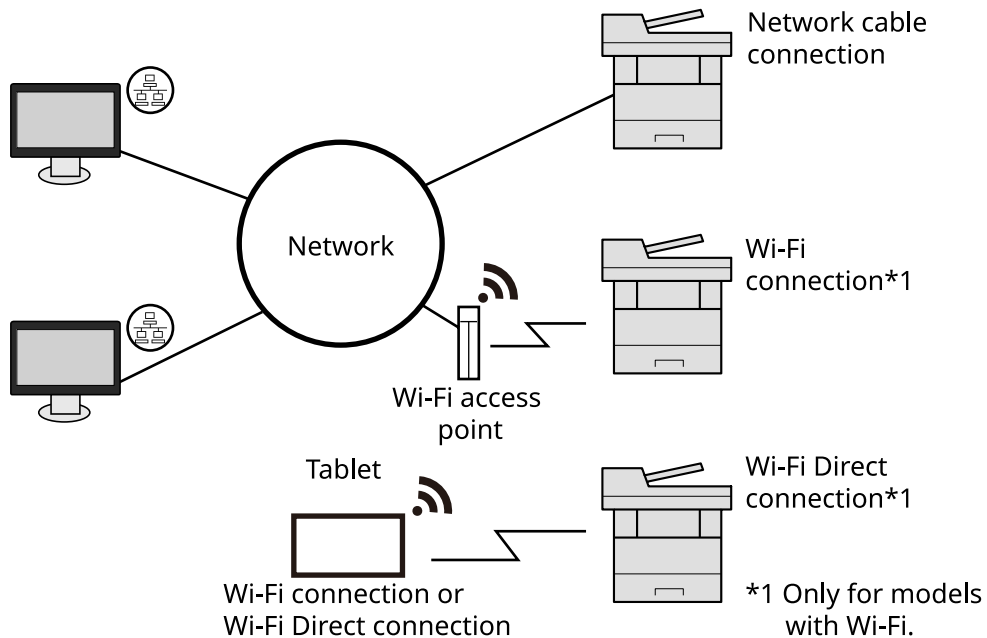

NOTE

If you are using wireless LAN, refer to the following.

➔ [Configuring the Wireless Network \(page 81\)](#)

Cables that Can Be Used

When a network cable is used to connect the machine

Function	Necessary Cable
Printer/Scanner/Network FAX*2	LAN cable (10BASE-T, 100BASE-TX, 1000BASE-T)

When a USB cable is used to connect the machine

Function	Necessary Cable
Printer/Scanner (TWAIN/WIA)	USB 2.0 compatible cable (Hi-Speed USB compliant, max. 5.0 m, shielded)

*2 The fax function can be used on products equipped with fax capability. For more information on Network FAX, refer to the following:

➔ **FAX Operation Guide**



IMPORTANT

Using a cable other than a USB 2.0 compatible cable may cause failure.

Connecting Cables

Connecting LAN Cable

✔ IMPORTANT

If the power is on, turn the power switch off.

➔ [Power off \(page 50\)](#)

1 Connect the cable to the machine.

- 1 Connect the LAN cable to the network interface connector.

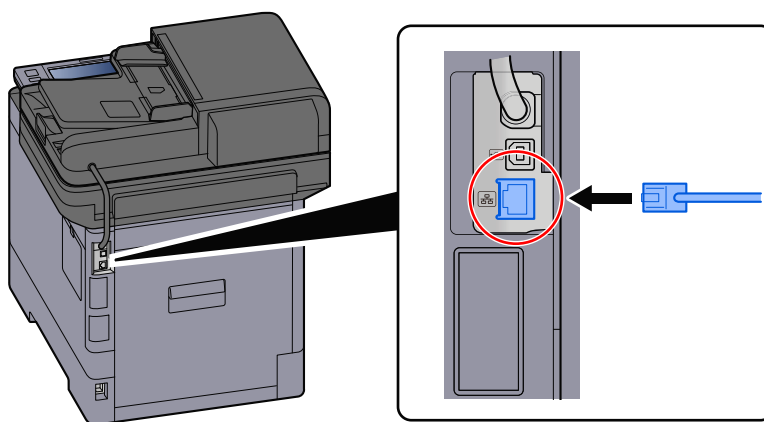

- 2 Connect the other end of the cable to the hub.

2 Power on the machine and configure the network.

➔ [Network Setup \(page 79\)](#)

Connecting USB Cable

 **IMPORTANT**

If the power is on, turn the power switch off.

➔ [Power off \(page 50\)](#)

1 Connect the cable to the machine.

- 1 Connect the USB cable to the USB interface connector.

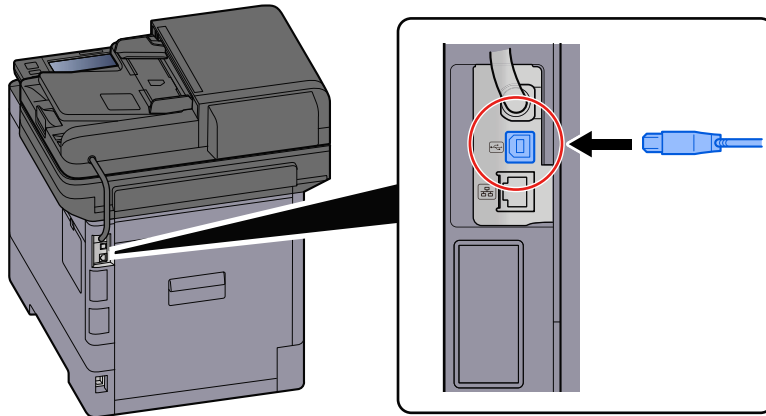

- 2 Connect the other end of the cable to the PC.

2 Power on the machine.

Connecting the Power Cable

1 Connect the cable to the machine.

Connect one end of the supplied power cable to the machine and the other end to a power outlet.

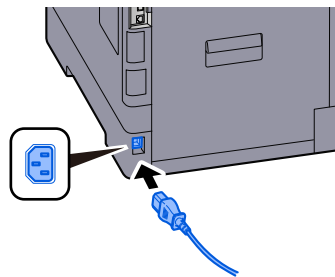

 **IMPORTANT**

Only use the power cable that comes with the machine.

Power On/Off

Power on

- 1 Turn the power switch on.

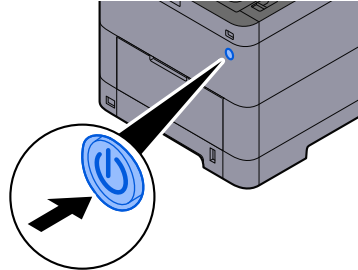

 **IMPORTANT**

When turning off the power switch, do not turn on the power switch again immediately. Wait more than 5 seconds, and then turn on the power switch.

Power off

- 1 Turn the power switch off.

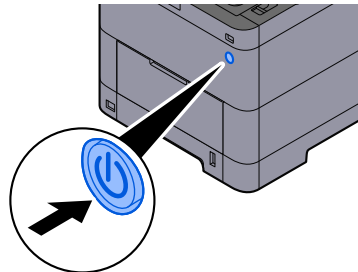

The confirmation message for power supply off is displayed.

It takes approximately 3 minutes for power off.

 **CAUTION**

If this machine will be left unused for an extended period (e.g. overnight), turn it off at the power switch. If the machine will not be used for an even longer period of time (e.g. vacation), remove the power plug from the outlet as a safety precaution.

 **IMPORTANT**

- If using the products equipped with the fax function, note that turning the machine off at the power switch disables fax transmission and reception.
 - Remove paper from the cassettes and seal it in the paper storage bag to protect it from humidity.
-

Using the Operation Panel

Operation Panel Keys

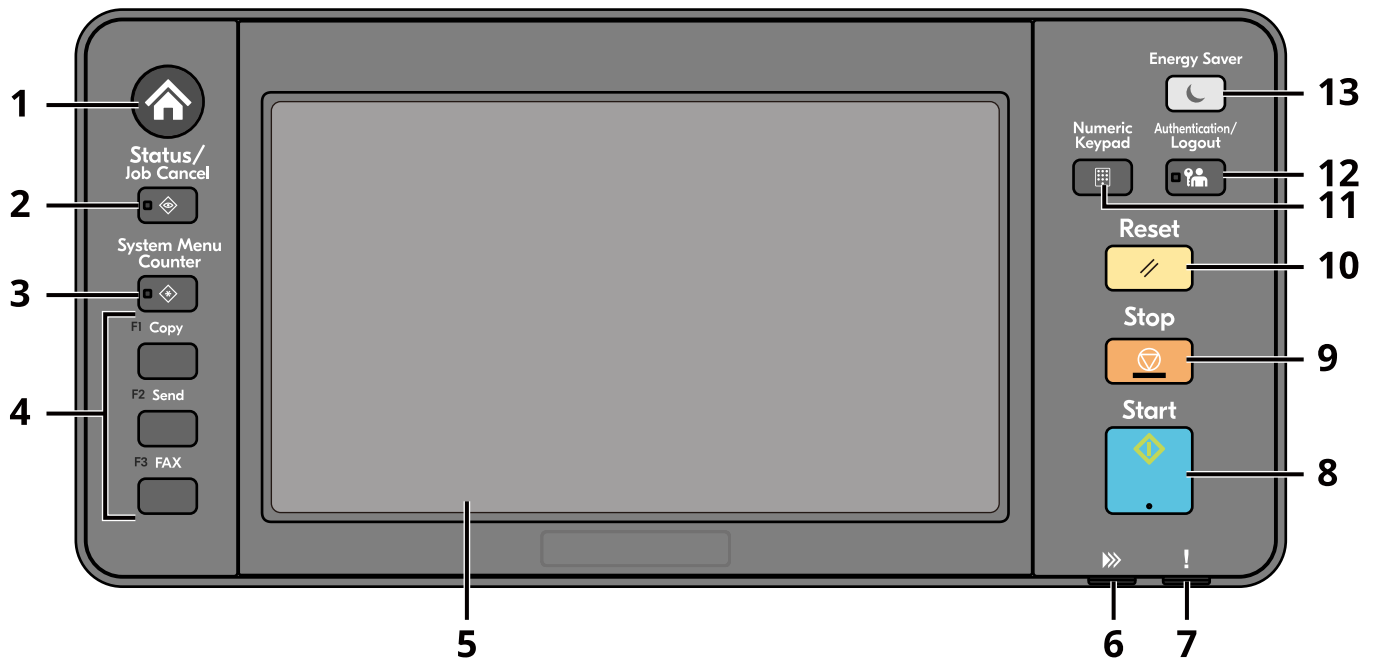

- 1 [Home] key
Displays the Home screen.
- 2 [Status / Job Cancel] key
Displays the Status/Job Cancel screen.
- 3 [System Menu / Counter] key
Displays the System Menu/Counter screen.
- 4 Function Keys
Keys to which various functions and applications, including copy and scan, can be assigned.
➔ [Function Key Assignment \(page 438\)](#)
- 5 Touch panel
The touch panel. Touch the keys here to configure various settings.
- 6 [Processing] indicator
Flashes during printing or transmission. Also, it is lit when there is a scheduled job using delayed transmission.
- 7 [Attention] indicator
Lights or blinks when an error occurs and a job is stopped.
- 8 [Start] key
Starts copying and scanning operations and processing for setting operations.
- 9 [Stop] key
Cancels or pauses the job in progress.
- 10 [Reset] key
Returns settings to their default states.

11 [Numeric Keypad] key

Calls the numeric keypad when typing a number or a symbol.

12 [Authentication / Logout] key

Authenticates user switching and finishes (logs out) the operation for each user.

13 [Energy Saver] key

Puts the machine into Sleep Mode. Recovers from sleep when in Sleep Mode.

Assigning Functions to Function Keys

Function keys are keys to which various functions and applications, including copy and scan, can be assigned. Frequently used functions and applications can be assigned and the screen can easily be displayed.

For this machine, the following functions are pre-assigned; however, alternative functions can be registered by re-assigning these functions. The labels included with this machine can be used to change the notation of the operation panel.

- [Function Key 1]: Copy
- [Function Key 2]: Send
- [Function Key 3]: ID card copy (If using a machine that is compatible with fax, the fax function will be assigned)

1 Display the screen.

[System Menu / Counter] key > [DeviceSettings] > [Function Key Assignment]



NOTE

If the user authentication screen appears, log in with a user who has the privilege to configure this setting. If you do not know your login user name or password, please contact your administrator.

2 Configure the settings.

- 1 Select the function key to be set.
- 2 Select the function to be assigned.

[None]

No function has been assigned.

[Copy]

Displays the Copy screen.

➔ [Basic Operation \(page 245\)](#)

[Send]

Displays the Send screen.

➔ [Basic Scanning \(Sending\) \(page 247\)](#)

[Fax Server]^{*1}

Displays the Fax Server screen.

➔ [Using a Fax Server to Send \(Fax Server Send\) \(page 266\)](#)

[Fax]^{*2}

Displays the Fax screen. For details, refer to the following:

➔ **FAX Operation Guide**

[Custom Box]^{*3}

Displays the Custom Box screen.

➔ [What is Custom Box? \(page 276\)](#)

[Job Box]

Displays the Job Box screen.

➔ [Printing Data Saved in the Printer \(page 207\)](#)

[USB Drive]

Displays the USB Drive screen.

➔ [Using Removable USB Drive \(page 297\)](#)

[Subaddress Box]^{*2}

Displays the Subaddress Box screen. For details, refer to the following:

➔ **FAX Operation Guide**

[Polling Box]^{*2}

Displays the Polling Box screen. For details, refer to the following:

➔ **FAX Operation Guide**

[Fax MemoryRXBox]^{*2}

Displays the Fax Memory RX Box screen. For details, refer to the following:

➔ **FAX Operation Guide**

[Send to Me (Email)]^{*4}

Displays the Send screen. The E-mail address of the logged-in user is set as the destination.

➔ [Sending Documents to E-mail Address of Logged in User \(to myself\) \(page 265\)](#)

[Send from Box (Email)]^{*3*4}

Displays the Custom Box screen. The E-mail address of the logged-in user is set as the destination.

➔ [Sending Documents to E-mail Address of Logged in User \(to myself\) \(page 291\)](#)

Favorite Name^{*5}

Calls up the registered favorite.

➔ [Recalling Frequently Used Functions \(Favorites\) \(page 230\)](#)

Application Name^{*6}

Displays the selected applications.

➔ [Using Applications \(page 238\)](#)

*1 This is displayed when the external server (Fax Server) is set.

*2 This item is displayed for fax-compatible machines.

*3 Displayed when the optional SSD is installed.

*4 Displayed when user login administration is enabled.

*5 The registered favorite will be displayed.

*6 The running application will be displayed.

Adjusting the Operation Panel Angle

The angle of the operation panel can be adjusted.

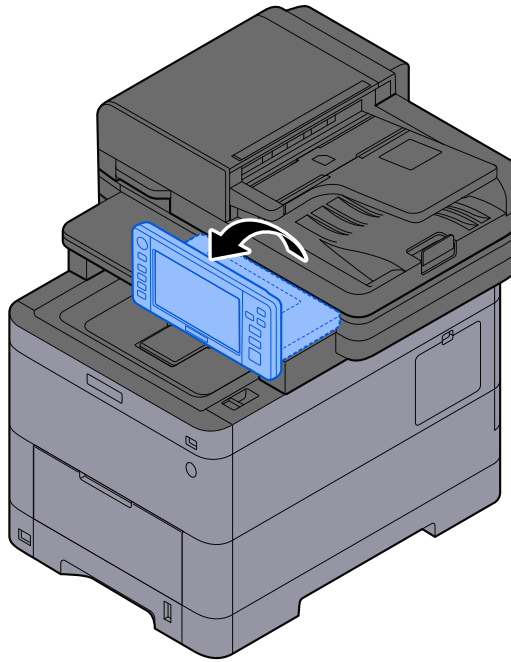

Touch Panel

Using the Touch Panel

This section explains the basic operation of the touch panel.

Tapping

This is the operation used to select an icon or key. In this guide, the tap operation is expressed as "select." In this document, the tap operation is expressed as "select."

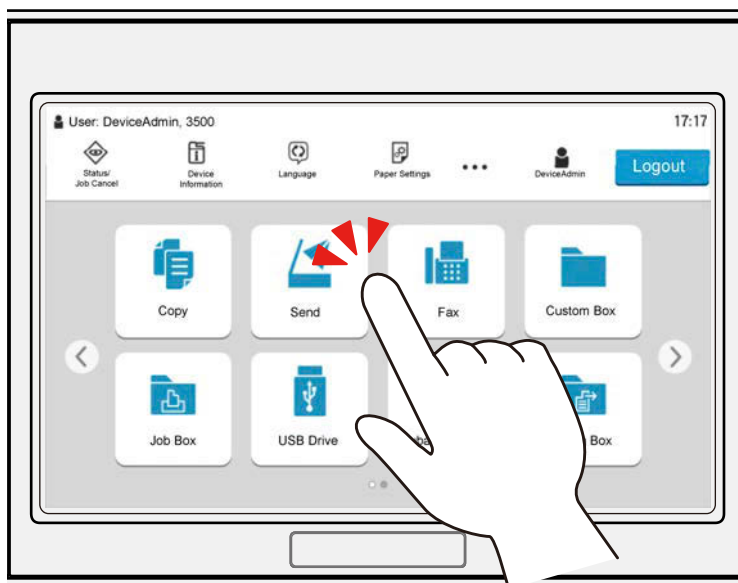

Popover

Tap the icons and keys to display detailed information on the icons and menus. A popover displays information and menus without switching between screens.

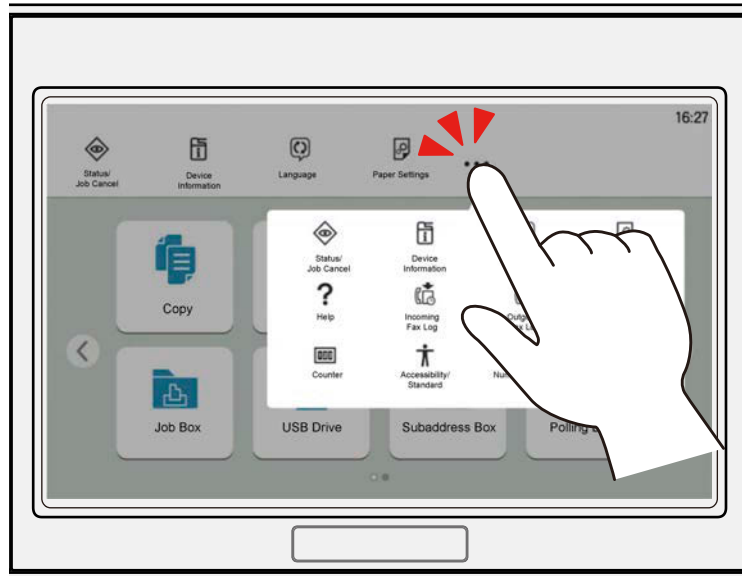

Swiping

This is the operation used to switch between screens and to display items that are not displayed in the list. Move in one direction as if tracing on the screen.

The figure shown below is an example of swiping Home Screen. Move the screen to the left and right.

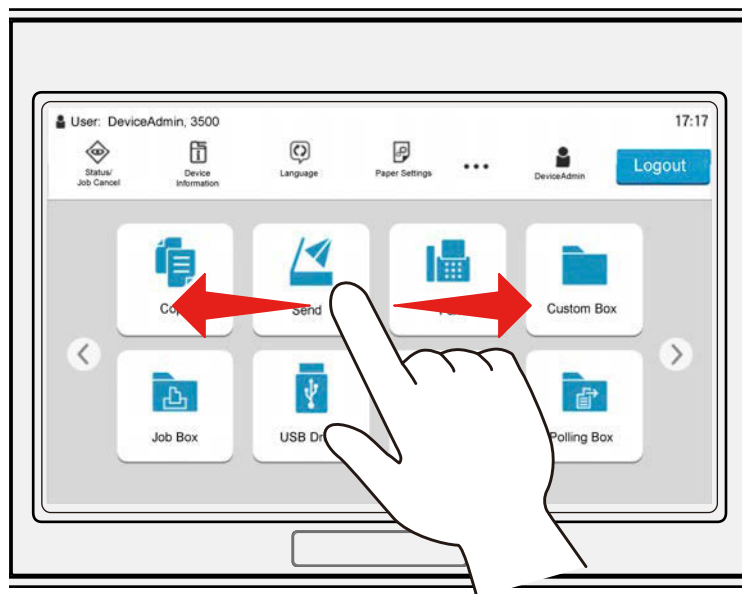

The figure shown below is an example of swiping System Menu Screen. Move the screen up and down.

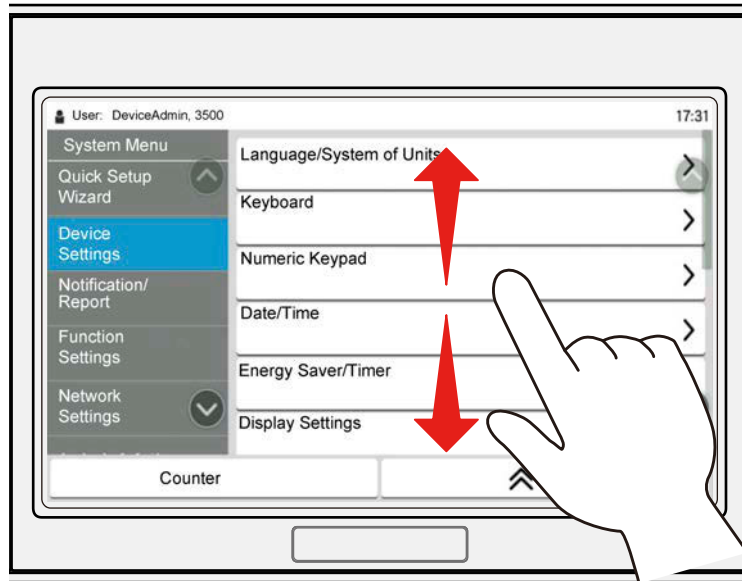

Operating the touch panel

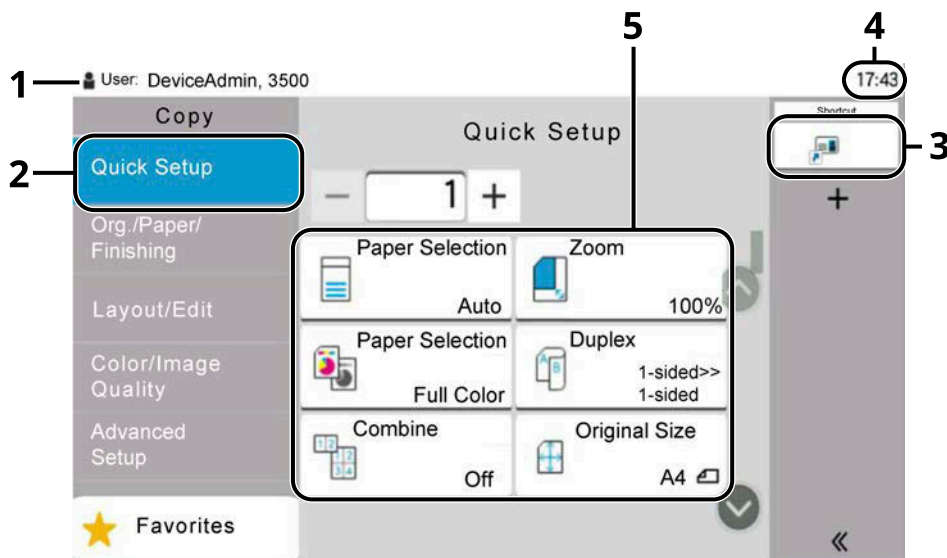

- 1 Displays the status of the equipment as well as necessary operation messages.
- 2 Displays the Quick Setup screen.
- 3 Displays registered shortcuts.
- 4 Displays the time.
- 5 Set the copy functions.

Home screen





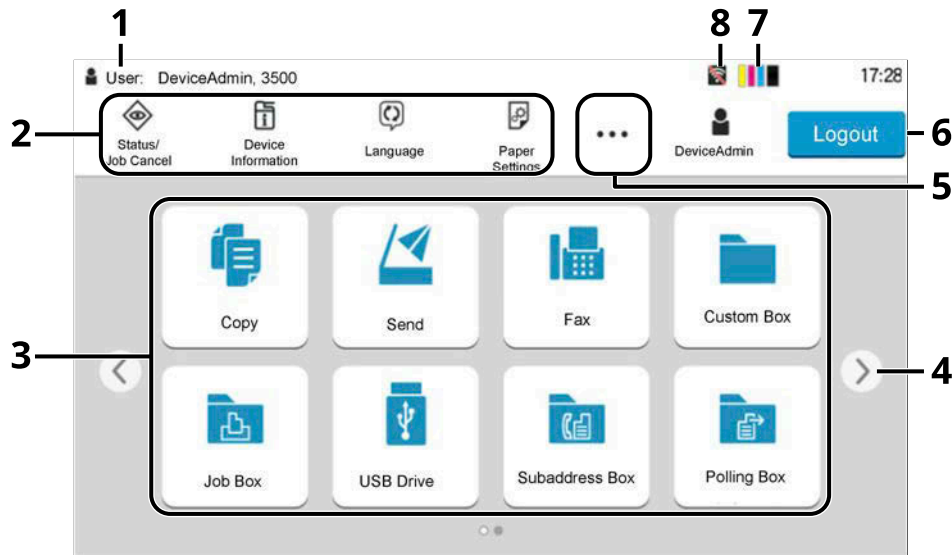



This screen is displayed by selecting the [Home] key on the operation panel. Touching an icon will display the corresponding screen. You can change the icons to display on the Home screen as well as its background.

➔ [Editing the Home Screen \(page 61\)](#)



The appearance may differ from your actual screen, depending on your configuration and option settings.

No.	Item	Description
1	Status Area	Displays the messages and status icons for the current status. Displays the logged-in user name when user login administration is enabled.
2	Taskbar	Displays task icons. If an error occurs, the [Status/Job Cancel] icon "!" will show. Once the error clears, the display will return to normal.
3	Desktop	Displays the application icons. Also displays registered favorite features. Icons that are not displayed on the first page will appear by changing the page.
4	Screen-switching keys	Use these buttons to switch between desktop pages.  NOTE It is also possible to use swiping to switch between displays. ➔ Using the Touch Panel (page 56)
5	[...]	Displays every task icons including the icons displayed in a taskbar area in a popover.
6	[Login]/[Logout]	Logs in or logs out when user login administration is enabled.
7	Remaining amount of toner	Displays the remaining amount of toner. Select this icon to display details of the remaining amount of toner in a popover.

No.	Item	Description
8	Sub status icons	Displays the icons that indicate the status of the machine. Five icons can be displayed. Select this area to display the icon information in a popover.
	Status icon (Wi-Fi)	The icon "  " is displayed when Wi-Fi is connected. When Wi-Fi is not connected, "  " is displayed.
	Status icon (Security level: Low)	"  " is displayed when the security level is set at [Low].
	Status icon (Remote operation)	"  " is displayed when using the remote operation.
	Status icon (Security information)	When you activate the Data Encryption/Overwrite Function, the Security information icon will be displayed. "  " is displayed while the data is overwriting. "  " is displayed if there is remaining data in the SSD. "  " is displayed if there is no remaining data in the SSD.
	Status icon (FAX Memory RX Box capacity)	"  " is displayed when the capacity of the FAX Memory RX Box is 10% or less.
	Status icon (USB drive)	"  " is displayed when a USB drive is connected to this machine. Tapping the USB drive icon and selecting [Remove USB] allows you to safely remove the USB drive.

Editing the Home Screen

You can change the background of the Home screen as well as which icons are displayed.

1 Display the screen.

[System Menu / Counter] key > [FunctionSettings] > [Home]

NOTE

If the user authentication screen appears, log in with a user who has the privilege to configure this setting. If you do not know your login user name or password, please contact your administrator.

2 Configure the function.

The following settings can be configured.

Customize Desktop

Specify the function icons to display on the desktop. Displays function icons including the installed applications and the functions that can be used when options are installed.

Select [Add] to display the screen for selecting the functions to display. Select [Filter] to narrow down the functions by application and favorites. Select the function to display and [OK].

Select an icon and [Previous] or [Next] to change the display position of the selected icon on the Desktop.

To delete an icon from the desktop, select the desired one and select [Delete].

Customize Taskbar

Specify the task icons to display on the taskbar. Select [Taskbar Button 1] to [Taskbar Button 4]. Select the function to display and [OK]. Four task icons can be displayed.

NOTE

Functions that are hidden can be displayed by selecting [...] (popover icon) on the right end of the taskbar.













Taskbar buttons for which [None] has been selected will not be displayed. Other taskbar buttons will be displayed from left to right.

Wallpaper

Configure the wallpaper of the Home screen.

Value: Images 1 to 8

Available Functions to Display on Desktop

Function	Icon	Description
Copy ^{*1}		Displays the Copy screen. ➔ Basic Operation (page 245)
Send ^{*1}		Displays the Send screen. ➔ Basic Scanning (Sending) (page 247)
Fax Server ^{*2}		Displays the Fax Server Send screen. ➔ Using a Fax Server to Send (Fax Server Send) (page 266)
Fax ^{*3}		Displays the Fax screen. ➔ FAX Operation Guide
Custom Box ^{*5}		Displays the Custom Box screen. ➔ What is Custom Box? (page 276)
Job Box ^{*5}		Displays the Job Box screen. ➔ Printing Data Saved in the Printer (page 207)
USB Drive ^{*1}		Displays the USB Drive screen. ➔ Using Removable USB Drive (page 297)
Subaddress Box ^{*3}		Displays the Subaddress Box screen. ➔ FAX Operation Guide
Polling Box ^{*3}		Displays the Polling Box screen. ➔ FAX Operation Guide
Fax Memory RX Box ^{*3}		Displays the Fax Memory RX Box screen. ➔ FAX Operation Guide
Send to Me (Email) ^{*5}		Displays the Send screen. The E-mail address of the logged-in user is set as the destination. ➔ Sending Documents to E-mail Address of Logged in User (to myself) (page 265)
Send to Me from Box (Email) ^{*4*5}		Displays the Custom Box screen. The E-mail address of the logged-in user is set as the destination. ➔ Sending Documents to E-mail Address of Logged in User (to myself) (page 291)
Favorites		Calls up the registered favorite. The icon will change according to the function of the favorite. ➔ Recalling Frequently Used Functions (Favorites) (page 230)
Application Name ^{*6}	—	Displays the selected applications. ➔ Using Applications (page 238)

*1 Selected at the time of shipment from factory.

*2 This is displayed when the external server (Fax Server) is set.















*3 This item is displayed for fax-compatible machines.

*4 Displayed when the optional SSD is installed.

*5 Displayed when user login administration is enabled.

*6 The icon of the application appears.

Available Functions to Display on Taskbar

Function	Icon	Description
Status/Job Cancel ^{*1}		Displays the Status/Job Cancel screen.
Device Information ^{*1}		Displays the Device Information screen. Check the system and network information, and information on the options that are used. It is also possible to print various reports and lists. ➔ Display for Device Information (page 65)
Language ^{*1}		Displays the Language setting screen in System Menu. ➔ Language/System of Units (page 420)
Paper Settings ^{*1}		Displays the Paper setting screen in System Menu. ➔ Paper Feeding (page 430)
Wi-Fi Direct ^{*2}		Wi-Fi Direct is set and a list of information relating to the machine that can use the network appears. ➔ Setting Wi-Fi Direct (page 88)
Help		Displays the Help screen. ➔ Help Screen (page 74)
User Property		Displays the User Property screen. ➔ Changing User Properties (page 527)
Incoming Fax Log ^{*3}		Displays the Incoming Fax Log screen. ➔ FAX Operation Guide
Outgoing Fax Log ^{*3}		Displays the Outgoing Fax Log screen. ➔ FAX Operation Guide
System Menu		Displays the System Menu screen. ➔ Operation Method (page 413)
Counter		Displays the Counter screen. ➔ Checking the Counter (page 116)
Accessibility/Standard		Magnifies the text and icons on the screen. Select Accessibility/Standard again to return to the previous view. ➔ Accessibility Functions (Magnifying the View) (page 75)
Numeric Keypad		Displays the numeric keys on the touch panel.
Favorites		Displays the favorite list screen. ➔ Recalling Frequently Used Functions (Favorites) (page 230)

*1 Selected at the time of shipment from factory.

*2 Displayed when the optional Wireless Network Interface Kit is installed.

*3 This item is displayed for fax-compatible machines.

Display for Device Information

Shows device Information. It is possible to check the status of the system and network, the status of consumables such as toner and paper and the situation of the options being used. It is also possible to print various reports and lists.

1 [Home] key > [DeviceInformation]

2 Check the device Information.

[Identification/Wired Network]

You can check ID information such as the model name, serial number, host name and location, and the IP address of the wired network.

[Wi-Fi]

You can check the status of Wi-Fi connection, such as the device name, network name and IP address. Displayed when the optional Wireless Network Interface Kit is installed.

[Supplies/Unit Condition]

You can check the presence of toner and paper, and the condition of the unit.

[Fax]

You can check the local fax number, local fax name, local fax ID and other fax information. This item is displayed only for fax-compatible machines.

[USB/Bluetooth]

You can check the connection status of USB drive and Bluetooth keyboard.

[Option/Application]

You can check information on the options and applications that are used.

[Capability/Version]

You can check the software version and performance.

[Security]

You can check the security information on the machine.

[Report]

You can print various reports and lists.

[Remote Ope.Status]

You can check the status of remote operation.

Display Setting Screen

The following procedure is an example of the Copy screen.

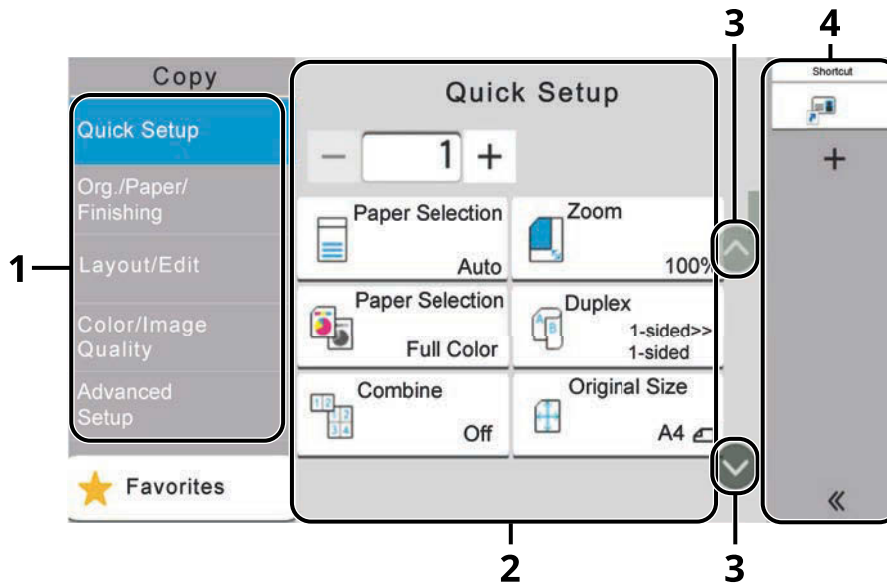

- 1 Global Navigation
Displays the function categories.
- 2 Body
Displays various copying functions.
- 3 Arrow Button
Move the screen up and down.
- 4 Right Pane Area
Displays shortcuts.

To configure the settings for functions, select the Global Navigation. Select the Arrow Button to display the following functions.

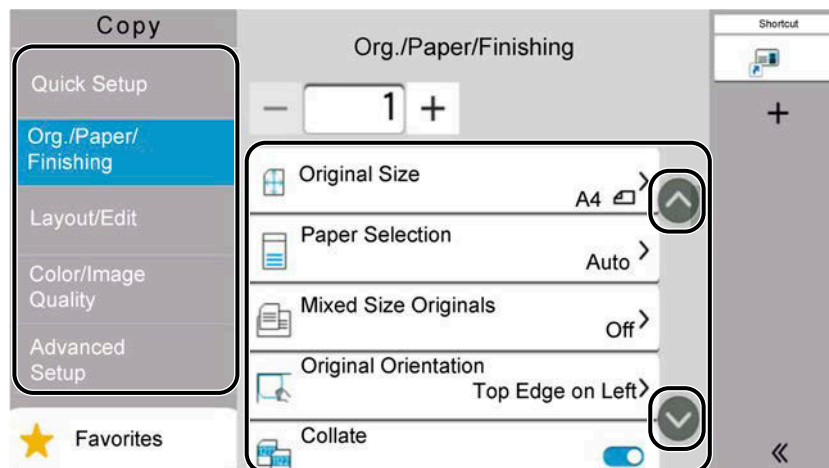

When an On/Off Flipswitch is displayed for a function, select the switch to change between ON and OFF.

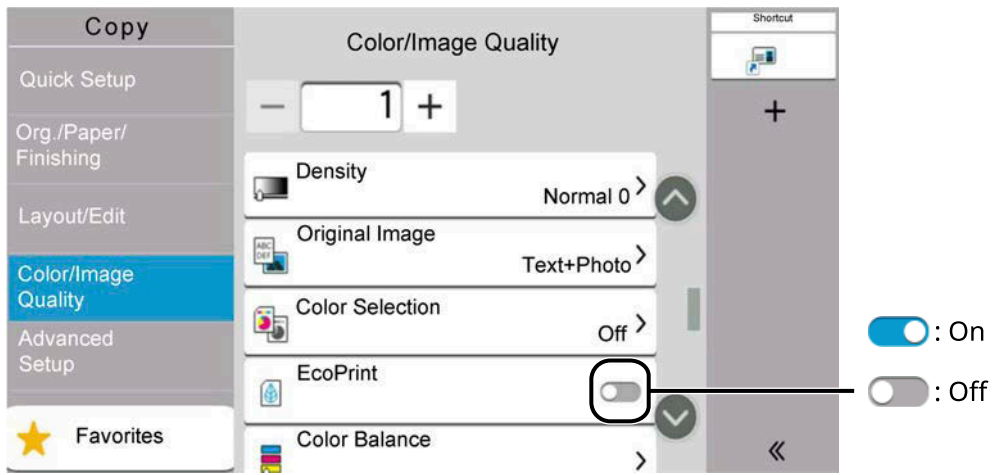

Display of Keys That Cannot Be Set

Keys of features that cannot be used due to feature combination restrictions or non-installation of options are in a nonselectable state.

Normal

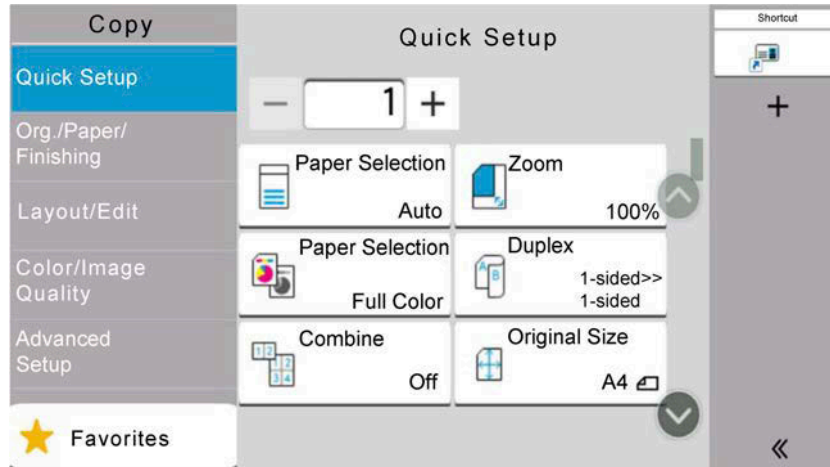

Grayed out

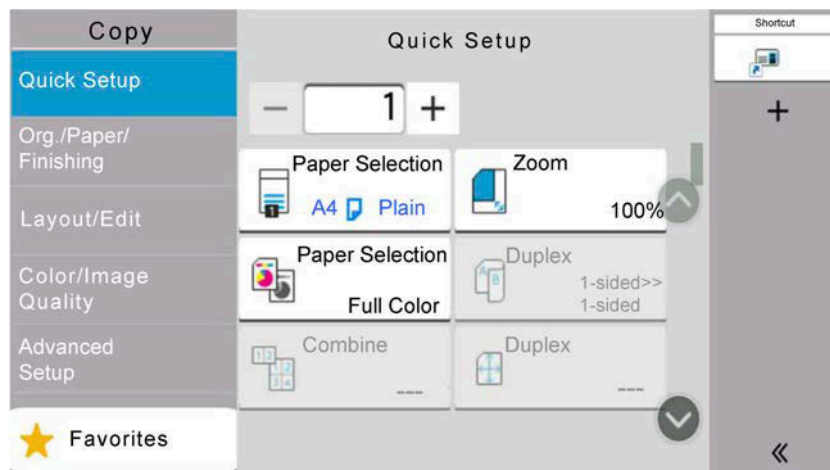

In the following cases, the key is grayed out and cannot be selected.

- Cannot be used in combination with a feature that is already selected.
- Use prohibited by user control.
- For functions that cannot be changed when using proof copy.

Normal

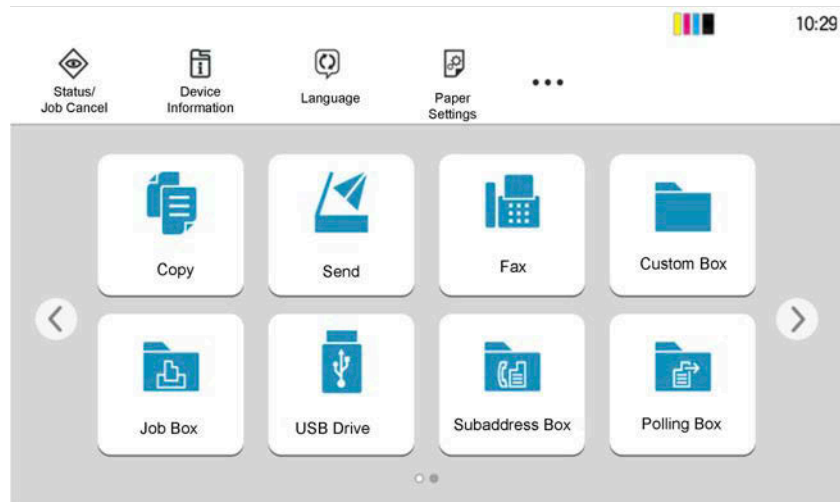

Hidden

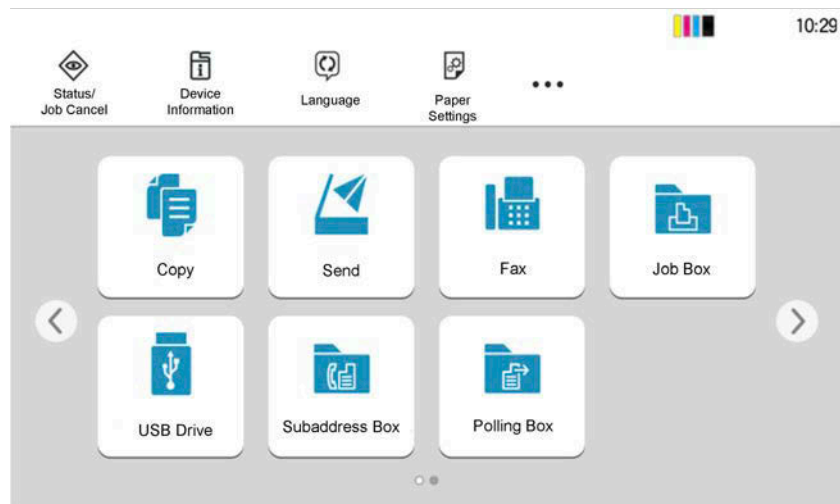

Cannot be used because an option is not installed.

Example) The [Custom Box] is not displayed when an SSD is not installed.

NOTE

- If a key that you wish to use is grayed out, the settings of the previous user may still be in effect. In this case, select the [Reset] key and try again.
- If the key is still grayed out after the [Reset] key is selected, it is possible that you are prohibited from using the function by user login administration. Check with the administrator of the machine.

Original Preview

You can display a preview image of the scanned document on the panel.

NOTE

To view a preview of an image stored in a Custom Box, refer to the following:

➔ [Previewing Documents/Checking Document Details \(page 281\)](#)

The procedure described here is for sending a single-page original.

1 Display the screen.

[Home] key > [Send]

2 Place the original and enter the destination.

3 Display a preview image.

1 Select [Preview].

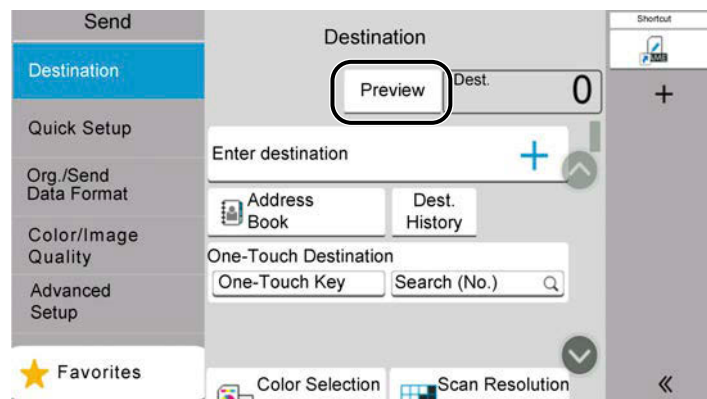

The machine starts scanning the original. When scanning is completed, the preview image appears on the panel.

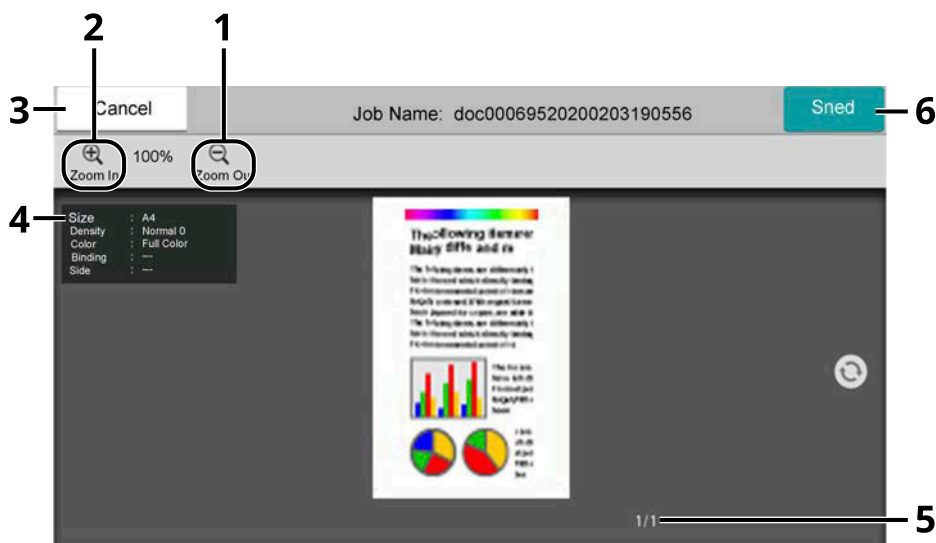

1 Zoom out.

2 Zoom in.

- 3 Cancel the job.
- 4 Displays the data information.
- 5 Displays the current number of pages and overall number of pages.
- 6 Start the sending.



NOTE

- To change the quality or the layout, select [Cancel].
Change the settings and select [Preview] again to see a preview image with the new settings.
- Depending on the function you are using, even if you scan a multi-page original document, only the first page can be previewed.

-
- 2 If there is no problem with the preview image, select [Send].
Sending starts.

Using the Preview Screen

When the Preview screen is displayed, you can do the following by moving the finger that is touching the touch panel.

Swipe

If a document with multiple pages is placed on the Document Processor, then all of the document is read and then the preview for the first page is displayed. Swipe the preview to the left and right to display a preview of the pages in the order read.

Drag

With the finger touching the touch panel, slide the finger to move the position of the displayed preview.

Pinch in/Pinch out

With two fingers touching the touch panel, widen or tighten the space between the two fingers to zoom in and out on the view.

Entering Numbers

When entering numbers, numeric keys appear on the touch panel if you select the area in which the number is entered.

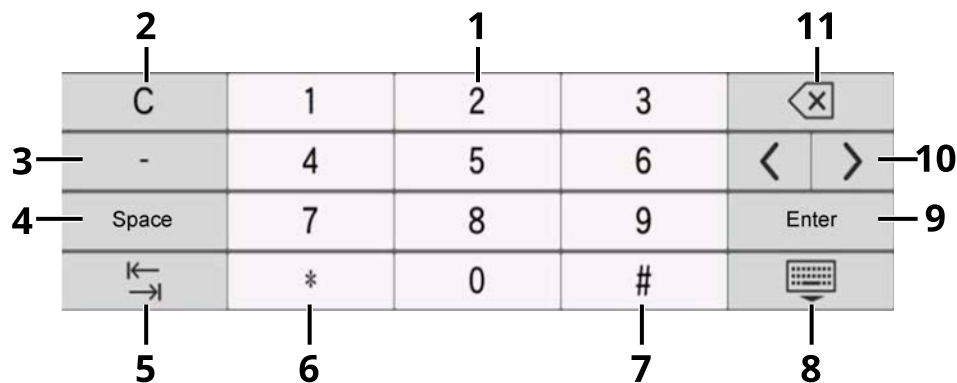

- 1 Enter numbers.
- 2 Clear entered numbers.
- 3 Enters [-].
- 4 Insert a space.
- 5 Move to the next input box.
- 6 When [.] is displayed: Enter the decimal point. The numbers entered after selecting this key will be the numbers after the decimal point.
[]When [] is displayed: Enters [*].
- 7 When [+/-] is displayed: Switches between positive and negative numbers.
When [#] is displayed: Enters [#].
- 8 Close the numeric keypad.
- 9 Entry by numeric keys is confirmed.
- 10 Move the cursor.
- 11 Delete a character to the left of the cursor.

NOTE

- Depending on the item being entered, some of the keys other than the number keys may not be usable.
- Numeric keys do not appear on the touch panel if an optional numeric keypad is installed.

Example: When entering the number of copies

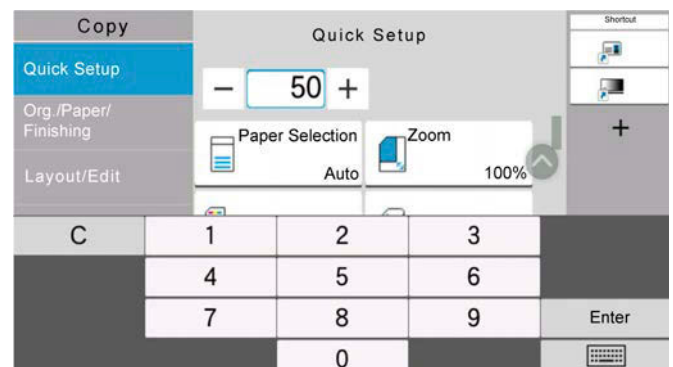
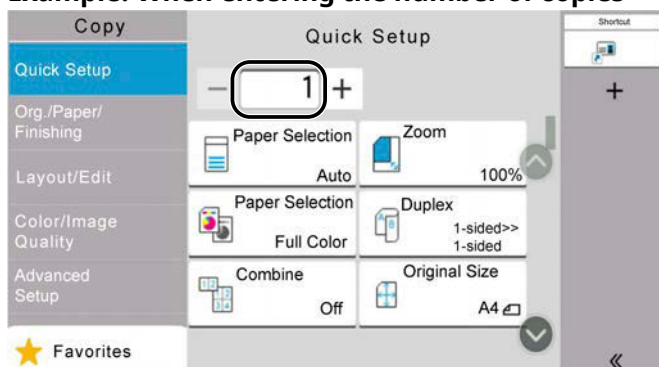

Example: When entering a one-touch key number

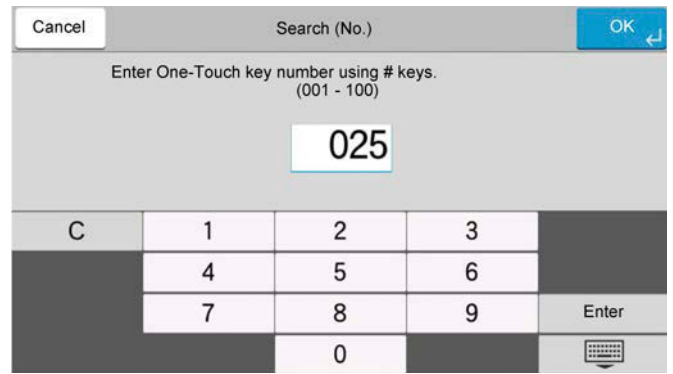
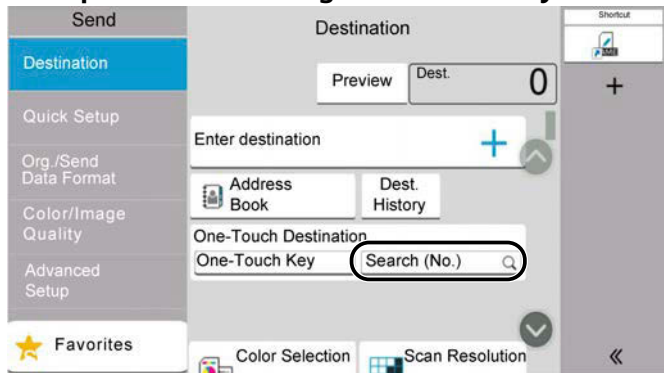

Example: When searching for an address number

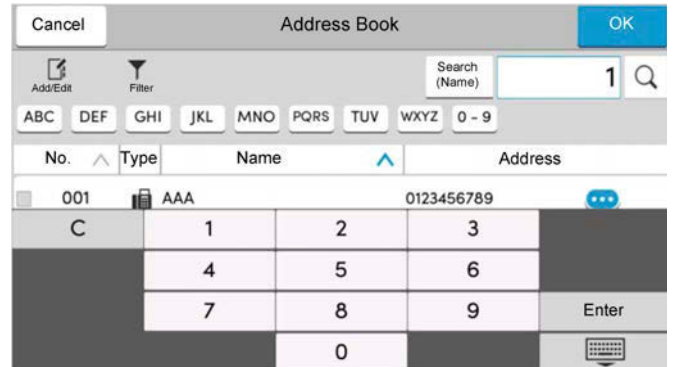
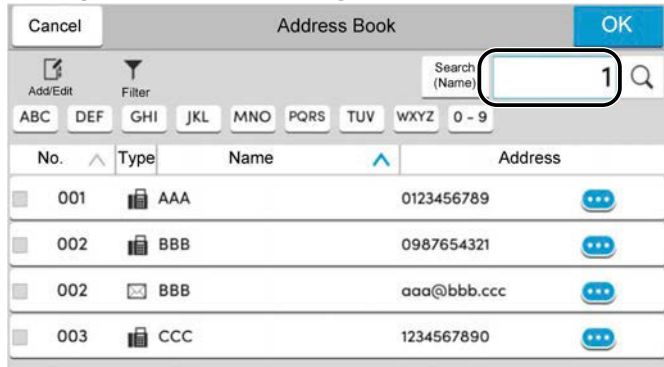

NOTE

For copy and print screens, you can set numeric keys to be displayed in advance. In addition, you can select the layout for numeric keys that are used on the application.

➔ [Numeric Keypad \(page 420\)](#)

Help Screen

If you have difficulty operating the machine, you can check how to operate it using the touch panel. Select [Help] on the Home screen to show the Help list.

1 [Home] key > [...] > [Help]

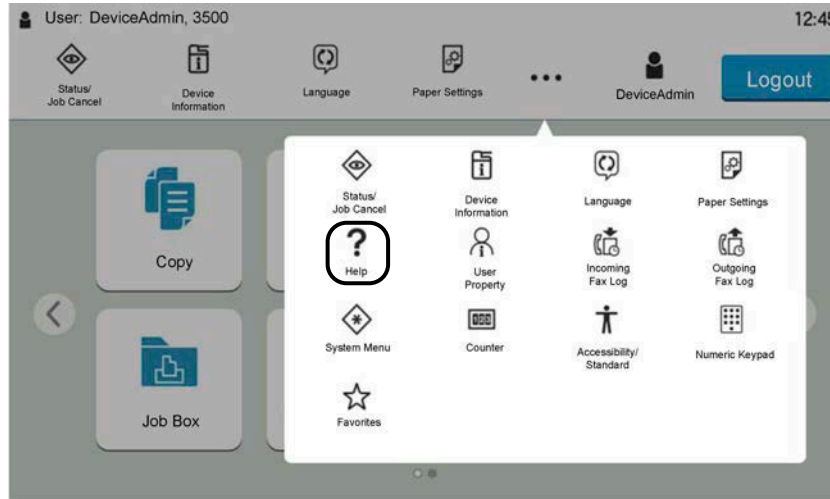

2 Select the items to check from the list.

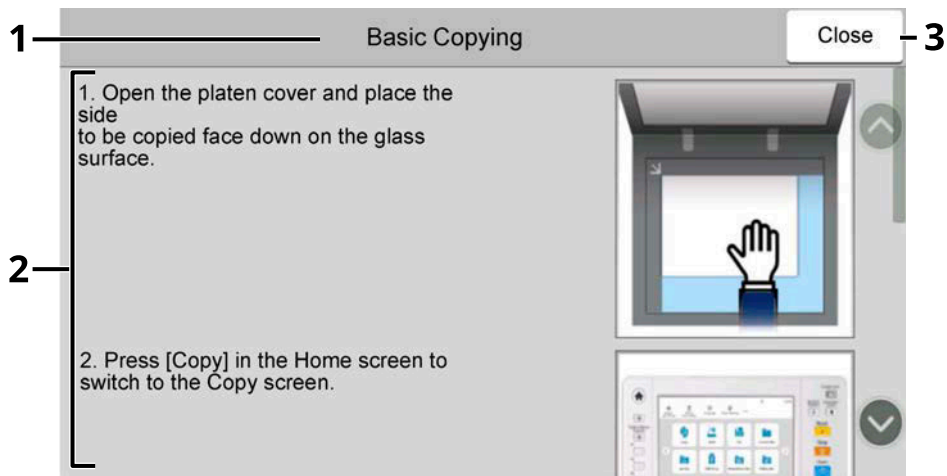
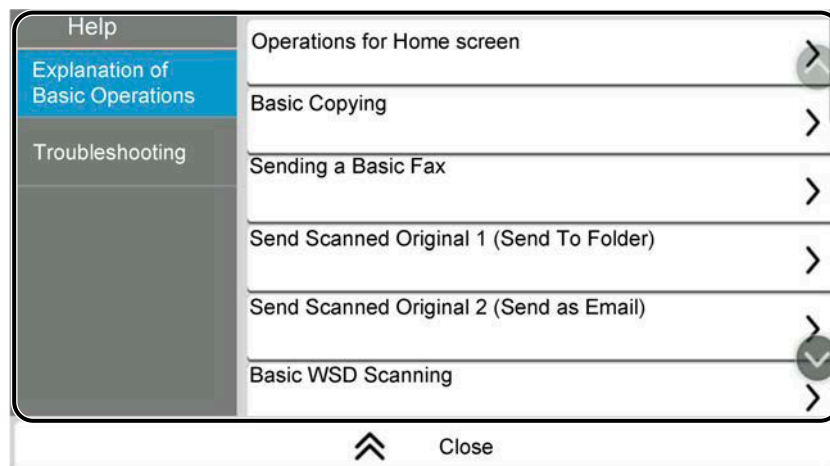

- 1 Help titles
- 2 Displays information about functions and machine operation.
- 3 Closes the Help screen and returns to the original screen.

Accessibility Functions (Magnifying the View)

You can magnify the text and keys displayed on the touch panel. You can also select items and move to the next screen using the numeric keys.

1 Select [Home] key > [...] > [Accessibility/Standard].

Large keys and text appear on the touch panel.



NOTE

- This function can be used on the Home screen and on the functions that were registered via Copy/Send/Fax Quick Setup.
- To configure any functions that are not displayed on the Accessibility screen, you need to return to the original view. Select [Accessibility/Standard] again.
- Long press the [Home] key to switch between the Standard screen and the Accessibility screen.

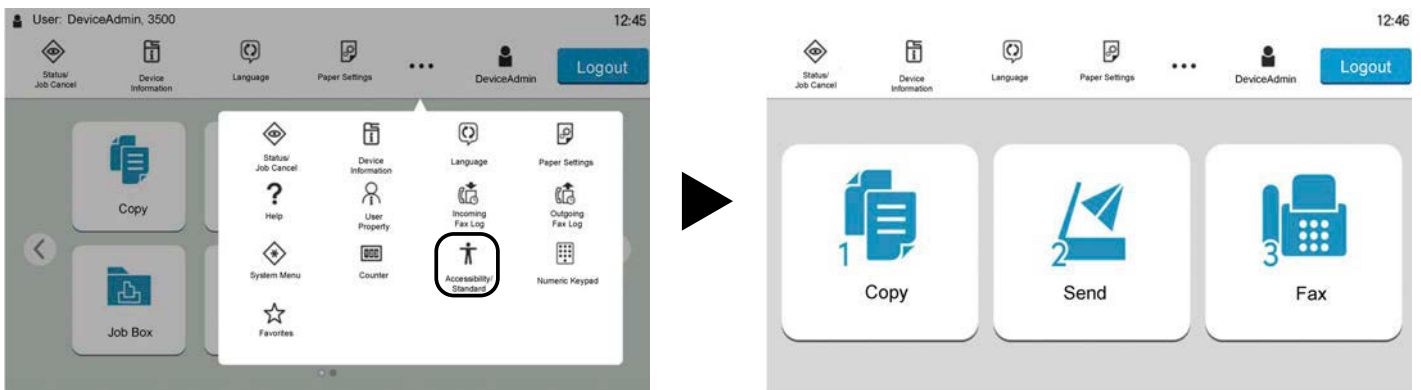

You can also control the screen using the numeric key corresponding to the number. (Example: Select the [2] key on the numeric key pad to display the Send screen.)

Control the functions according to the display on the screen.

Login/Logout

Login

1 Enter the login user name and login password to login.

If this screen is displayed during operations, enter the login user name and login password.

The screenshot shows the 'Keyboard Login' dialog box. At the top left is a 'Cancel' button. The title is 'Keyboard Login'. Below the title is the instruction 'Enter login user name and password.' There are three input fields: a dropdown menu for 'Login to' (set to 'Local'), a text field for 'Login User Name' (containing '3500'), and a text field for 'Password' (containing '****'). A 'Login' button with a right arrow is to the right of the password field. Below these fields are three buttons: 'Other Login', 'Wi-Fi Direct', and 'Check Counter'. Numbered callouts 1 through 6 point to these elements: 1 points to the 'Login to' dropdown, 2 points to the 'Login User Name' field, 3 points to the 'Password' field, 4 points to the 'Other Login' button, 5 points to the 'Wi-Fi Direct' button, and 6 points to the 'Check Counter' button.

1 If the user authentication method is set to [Network Authentication], the authentication destination is displayed. Select [Local] or [Network] for the authentication destination.

2 Enter the login user name.



NOTE

If you do not know your login User Name, please contact your Administrator.

3 Enter the login password.

➔ [Character Entry Method \(page 748\)](#)



NOTE

If you do not know your login Password, please contact your Administrator.

4 Select [Simple Login], [PIN Login], or [ID Card Login] as the login method.

➔ [User Authentication and Accounting \(User Login, Job Accounting\) \(page 518\)](#)

5 Check the Wi-Fi Direct environment.

6 Refer to the number of pages printed and the number of pages scanned. Displayed when job accounting is enabled.

2 Select [Login].

Simple Login

- 1 If the following screen is displayed during operations, select a user and log in.

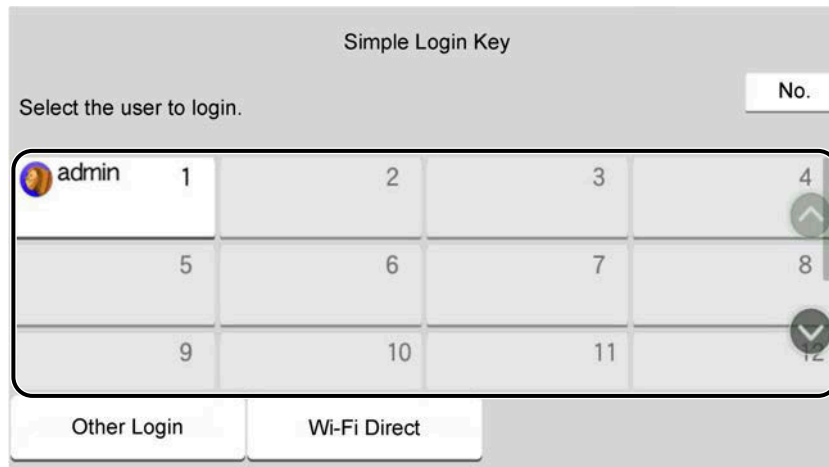

NOTE

If a user password is required, an input screen will be displayed.

→ [Enabling Simple Login \(page 545\)](#)

Logout

- 1 Select [Logout].

Return to the login user name/login password entry screen.

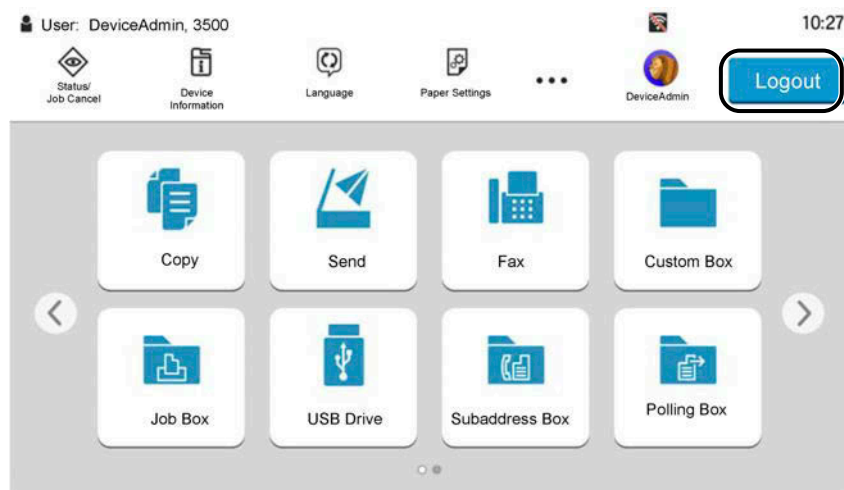

NOTE

Users are automatically logged out in the following circumstances:

- When the machine enters the sleep state.
- When the auto panel reset function is activated.

Default Settings of the Machine

The default settings of the machine can be changed in System Menu. Before using this machine, configure such settings as date and time, network configuration, and energy saving functions as needed.

NOTE

For settings that are configurable from System Menu, refer to the following:

➔ [System Menu \(page 412\)](#)

Setting Date and Time

Follow the steps below to set the local date and time at the place of installation. When you send an E-mail using the transmission function, the date and time as set here will be printed in the header of the E-mail message. Set the date, time and time difference from GMT of the region where the machine is used.

NOTE

- To make changes after this initial configuration, refer to the following:
 - ➔ [Date/Time \(page 421\)](#)
 - The correct time can be periodically set by obtaining the time from the network time server.
 - ➔ **Command Center RX User Guide**
-

1 Display the screen.

[System Menu / Counter] key > [DeviceSettings] > [Date/Time]

2 Configure the settings.

Select and set [Time Zone] > [Date and Time] > [Date Format] in this order.

[Time Zone]

Set the time difference from GMT. Choose the nearest listed location from the list. If you select a region that utilizes summer time, configure settings for summer time.

[Date and Time]

Set the date and time for the location where you use the machine. If you perform Send as Email, the date and time set on the machine will be displayed on the header.

Value: Year (2000 to 2035), Month (1 to 12), Day (1 to 31), Hour (0 to 23), Minute (0 to 59), Second (0 to 59)

[Date Format]

Select the display format of year, month, and date. The year is displayed in Western notation.

Value: [MM/DD/YYYY], [DD/MM/YYYY], [YYYY/MM/DD]

Network Setup

Configuring the Wired Network

The machine is equipped with network interface, which is compatible with network protocols such as TCP/IP (IPv4), TCP/IP (IPv6), NetBEUI, and IPSec. It enables network printing on the Windows, Mac, UNIX and other platforms. The configuration methods are as follows:

Configuration Method	Description
Configuring the Connection from the Operation Panel on This Machine	<p>Use Quick Setup Wizard when configuring the network in a wizard-style screen, without setting individually in System menu.</p> <p>➔ Configuring Settings Quick Setup Wizard (page 95)</p> <p>Use Wired Network Settings or Optional Network to configure the network in details from System menu.</p> <p>➔ Wired Network Settings (page 484)</p> <p>➔ Optional Network (page 496)</p>
Configuring Connections on the Web Page	<p>For the equipped network interface, the connection can be set by using Command Center RX. For the IB-50, the connection can be set on the dedicated Web page.</p> <p>➔ Command Center RX User Guide</p> <p>➔ IB-50 Operation Guide</p>
Setting the Connection by Using the Setup Utility of IB-50	<p>This is the setup tool included in the CD of IB-50. You can use it on Windows.</p> <p>➔ IB-50 Operation Guide</p>

NOTE

When you want to switch to the network interface other than Wired (default) after installing an optional Network Interface Kit (IB-50) and a Wireless Network Interface Kit (IB-37/IB-38/IB-51), select the desired setting on [Primary Network (Client)].

➔ [Primary Network \(Client\) \(page 500\)](#)

For other network settings, refer to the following:

➔ [NetworkSettings \(page 476\)](#)

TCP/IP (IPv4) setting

NOTE

If the user authentication screen appears, log in with a user who has the privilege to configure this setting. If you do not know your login user name or password, please contact your administrator.

1 Display the screen.

[System Menu / Counter] key > [NetworkSettings] [Wired Network Settings] > "TCP/IP Settings" [IPv4 Settings]

2 Configure the settings.

- When using DHCP server
 - [DHCP]: On
- When setting the static IP address
 - [DHCP]: Off
 - [Auto-IP]: Off
 - [IP Address]: Enter the address.
 - [Subnet Mask]: Enter the subnet mask in decimal representation (0 to 255).
 - [Default Gateway]: Enter the address.
- When using the Auto-IP
 - Enter "0.0.0.0" in IP Address.
- When setting the DNS server
 - In the following cases, set the IP address of DNS (Domain Name System) server.
 - When using the host name with [DHCP] setting set to Off.
 - When using the DNS server with IP address that is not assigned by DHCP automatically.

Select [Use DNS Server from DHCP] or [Use the following DNS Server]. If you selected [Use the following DNS Server], enter the [DNS Server (Primary)] and [DNS Server (Secondary)].

IMPORTANT

After changing the setting, restart the network from System Menu, or turn the machine OFF and then ON.

➔ [Restart the network \(page 495\)](#)

NOTE

Ask your network administrator for the IP address in advance, and have it ready when you configure this setting.

Configuring the Wireless Network

When the optional Wireless Network Interface Kit (IB-37, IB-38, or IB-51) is installed on the machine and the connection settings are configured, it is possible to print or send in a wireless network (wireless LAN) environment.

➔ [IB-37/IB-38 <Wireless network interface \(USB: 5GHz/2.4GHz\)> \(page 743\)](#)

➔ [IB-51 <Wireless network interface \(KUIO: 2.4GHz\)> \(page 744\)](#)

The configuration methods are as follows:

Configuration Method	Description
Configuring the Connection from the Operation Panel on This Machine	<p>Use Quick Setup Wizard when configuring the network in a wizard-style screen, without setting individually in System menu.</p> <p>➔ Configuring Settings Quick Setup Wizard (page 95)</p> <p>Use Wi-Fi Settings or Wireless Network to configure the network in details from System menu.</p> <p>➔ Wi-Fi Settings (page 478)</p> <p>➔ Wireless Network (page 496)</p>
Setting the Connection by Using the Wi-Fi Setup Tool	<p>This is a tool that can be downloaded from Download Center (https://kyocera.info/). You can configure the connection according to the instructions provided by the wizard.</p> <p>➔ Wired Connection with LAN Cable Using Wi-Fi Setup Tool (page 82)</p>
Setting the Connection by Using the Setup Utility of IB-51	<p>This is the setup tool included in the CD of IB-51. You can use it on both Windows and Mac OS.</p> <p>➔ IB-51 Operation Guide</p>
Configuring Connections on the Web Page	<p>For the IB-37/IB-38, the connection can be set on the Command Center RX.</p> <p>➔ Command Center RX User Guide</p>
	<p>For the IB-51, the connection can be set on the dedicated Web page.</p> <p>➔ IB-51 Operation Guide</p>

NOTE

When you want to switch to the network interface other than Wired (default) after installing an optional Network Interface Kit (IB-50) and a Wireless Network Interface Kit (IB-37/IB-38/IB-51), select the desired setting on [Primary Network (Client)].

➔ [Primary Network \(Client\) \(page 500\)](#)

Wired Connection with LAN Cable Using Wi-Fi Setup Tool

To send the Wi-Fi settings configured in the Wi-Fi Setup Tool to the machine, connect the computer or mobile device with the machine locally. To use a wired LAN cable directly connected to the machine, the Auto-IP (Link-local) address will be assigned to the machine and the computer. This machine applies Auto-IP as the default settings.

NOTE

Configure the settings on the operation panel if your computer supports WPS.

→ [Wi-Fi Settings \(page 478\)](#)

→ [Wireless Network \(page 496\)](#)

1 Connect the machine with a computer.

1 Connect the machine with a computer via LAN cable when the machine is powered on.

2 Turn on the computer.

IP addresses (link local addresses) of the machine and computer are generated automatically.

2 Launch the Wi-Fi Setup Tool.

1 Launch your Web browser.

2 Enter "<https://kyocera.info/>" into the browser's address bar or location bar.

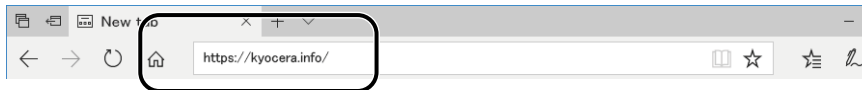

3 Enter and search the product name, and select this product from the candidate list.

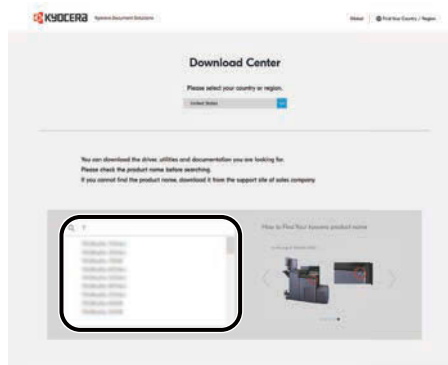

- 4 Change the selected operating system and its language setting as needed.

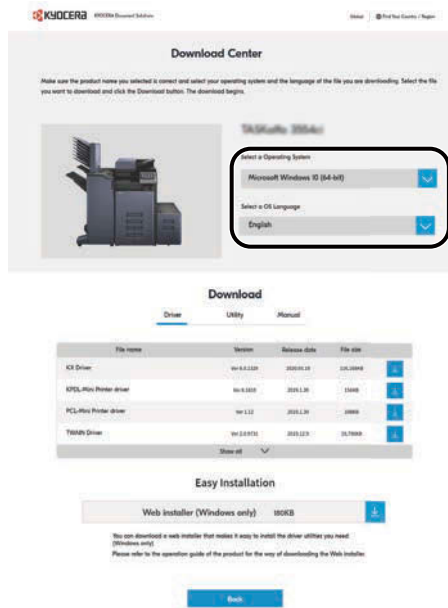

- 5 Utility tab > [Wi-Fi Setup Tool]
 The Wi-Fi Setup Tool will be downloaded.

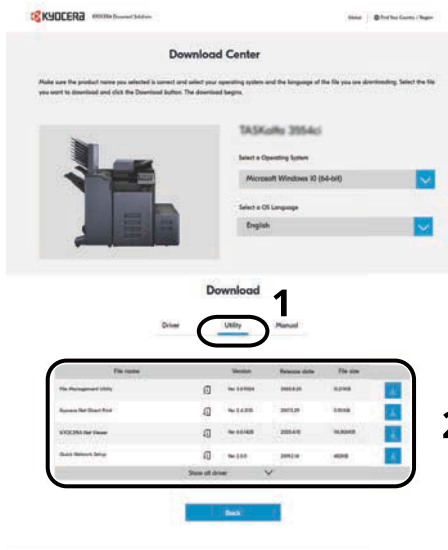

- 6 Double-click the downloaded installer to launch.

NOTE

- Installation on Windows must be done by a user logged on with administrator privileges.
- If the user account management window appears, click [Yes] (Allow).

3 Configure the settings.

1 [Do not use automatic configuration] > [Next] > [Next]

2 [Use LAN cable] > [Next] > [Next]

3 [Easy setup] > [Next]

The machine is detected.



NOTE

- Only one machine can be searched using Wi-Fi Setup Tool. It may take times to search the machine.
 - If the machine is not detected, select [Advanced setup] > [Next]. Select [Express] or [Custom] as device discovery method and specify the IP address or host name to search the machine.
-

4 Select the machine > [Next]

5 Select [Use the device settings.] on [Authentication mode], and enter the administrator's login user name and password.

6 Configure the communication settings > [Next]

7 Change the settings of access point as necessary > [Next]

The network is configured.

Wireless LAN Connection by Wi-Fi Direct Using Wi-Fi Setup Tool

To send the Wi-Fi settings configured in the Wi-Fi Setup Tool to the machine, connect the computer or mobile device with the machine locally.

To use Wi-Fi Direct, confirm that the Wi-Fi Direct is enabled (Wi-Fi Direct is set to ON) and Restart Network from the operation panel, before your computer will be connected to this machine with Wi-Fi Direct.

NOTE

Configure the settings on the operation panel if your computer supports WPS.

➔ [Wi-Fi Settings \(page 478\)](#)

➔ [Wireless Network \(page 496\)](#)

1 Display the screen.

[System Menu / Counter] key > [NetworkSettings] > "Network Settings" [Wi-Fi Direct Settings]

2 Configure the settings.

[Wi-Fi Direct]: On > [Close]

3 Restart the network.

[System Menu / Counter] key > [NetworkSettings] > "Network Settings"[Restart Network] > [Restart]

4 Connect a computer or a mobile device with the machine.

➔ [Setting Wi-Fi Direct \(page 88\)](#)

5 Launch the Wi-Fi Setup Tool.

1 Launch your Web browser.

2 Enter "<https://kyocera.info/>" into the browser's address bar or location bar.

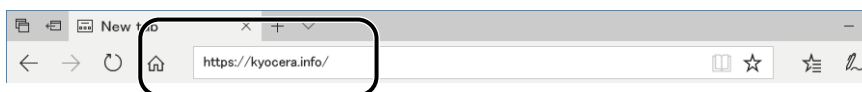

- 3 Enter and search the product name, and select this product from the candidate list.

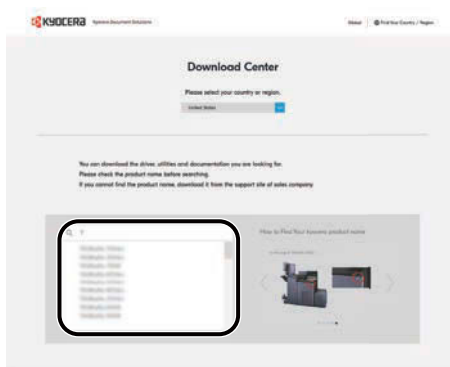

- 4 Change the selected operating system and its language setting as needed.

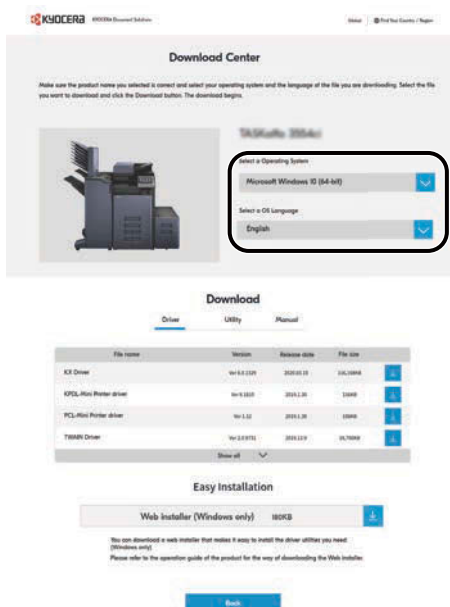

- 5 Utility tab > [Wi-Fi Setup Tool] 
The Wi-Fi Setup Tool will be downloaded.

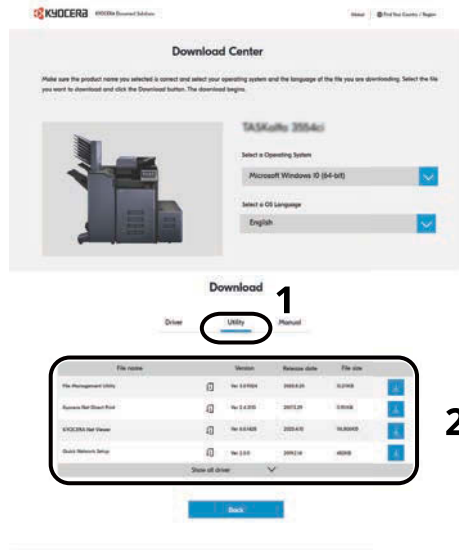

- 6 Double-click the downloaded installer to launch.



NOTE

- Installation on Windows must be done by a user logged on with administrator privileges.
- If the user account management window appears, click [Yes] (Allow).

6 Configure the settings.

- 1 [Do not use automatic configuration] > [Next] > [Next]
- 2 [Wi-Fi Direct] > [Next] > [Next]
- 3 [Advanced setup] > [Next]

Select [Express] or [Custom] as the device discovery method. You can specify an IP address or hostname as the discovery method.
- 4 Select the machine > [Next]
- 5 Select [Use the device settings.] on [Authentication mode], and enter the administrator's login user name and password.
- 6 Configure the communication settings > [Next]
- 7 Change the settings of access point as necessary > [Next]

The network is configured.

Setting Wi-Fi Direct

When the Optional Wireless Network Interface Kit (IB-37/IB-38) is installed on the machine and the connection settings are configured, this enables you to print from the Wi-Fi Direct environment. The configuration methods are as follows:

- Configuring the connection from the operation panel on this machine
- Configuring the connection by using push button

Connecting to Computers or Mobile Devices that Support Wi-Fi Direct

1 Display the screen.

[System Menu / Counter] key > [NetworkSettings] > "Network Settings" [Wi-Fi Direct Settings]

2 Configure the settings.

"Wi-Fi Direct": On > [OK]

3 Restart the network.

[System Menu / Counter] key > [NetworkSettings] > "Network Settings" [Restart Network] > [Restart]

4 Specify the machine name from the computer or mobile device.

If a confirmation message appears on the operation panel of the machine, select [Yes].

The network between this machine and the computer or mobile device is configured.

Connecting to Computers or Mobile Devices Unsupported Wi-Fi Direct

Here, we'll explain the procedures for connecting to iOS mobile devices.

1 Display the screen.

[System Menu / Counter] key > [NetworkSettings] > "Network Settings" [Wi-Fi Direct Settings]

2 Configure the settings.

"Wi-Fi Direct": On > [OK]

3 Restart the network.

[System Menu / Counter] key > [NetworkSettings] > "Network Settings" [Restart Network] > [Restart]

4 [Home] key > [DeviceInformation] > [Wi-Fi Direct/Wi-Fi]

5 Note the network name (SSID), IP address, and password of "Wi-Fi Direct"

6 Configure the mobile device.

1 [Settings] > [Wi-Fi]

2 Select the network name (SSID) appeared in step 5 from the list.

3 Enter the password that was provided in step 5 > [Connect]

The network between this machine and the computer or mobile device is configured.

Configuring the Connection by Using Push Button

When your computer or mobile device does not support Wi-Fi Direct but supports WPS, you can configure the network using push button.

1 Display the screen.

[System Menu / Counter] key > [NetworkSettings] > "Network Settings" [Wi-Fi Direct Settings]

2 Configure the settings.

"Wi-Fi Direct": On >[Close]

3 Restart the network.

[System Menu / Counter] key > [NetworkSettings] > "Network Settings" [Restart Network] > [Restart]

4 [Home] key > [DeviceInformation] > [Wi-Fi Direct/Wi-Fi]

5 Press the push button on the computer or mobile device and select "Wi-Fi Direct" [Push Button Setup] > [OK] on the screen of operation panel.

The network between this machine and the computer or mobile device is configured.



IMPORTANT

You can connect up to 10 mobile devices at the same time using Wi-Fi Direct setting. When the devices that support Wi-Fi Direct are connected, if you want to connect other device, disconnect the already connected devices from the network. The disconnection methods are as follows:

- Disconnect the network from the computer or mobile devices
 - Disconnecting all devices from the network on the operation panel
Select the [Home] key > [DeviceInformation] > [Wi-Fi Direct/Wi-Fi] > "Wi-Fi Direct" [Device] > [Disconnect] > [Disconnect].
 - Configuring auto disconnecting time from the System menu
➔ [Wi-Fi Direct Settings \(page 477\)](#)
 - Configuring auto disconnecting time from the Command Center RX
➔ **Command Center RX User Guide**
-

Energy Saver function

If a certain period of time elapses after the machine is last used, the machine automatically enters Sleep to minimize power consumption.

Sleep

To enter Sleep, select the [Energy Saver] key, touch panel and all indicators on the operation panel will go out to save a maximum amount of power except the Energy Saver indicator. This status is referred to as Sleep.



If print data is received during Sleep, the machine automatically wakes up and starts printing.

For fax-compatible models, when fax data arrives while the machine is in Sleep, the machine automatically wakes up and starts printing.

In addition, the machine wakes up when the following operations are performed:

- Select any key on the operation panel.
- Touch the touch panel.
- Place originals in the document processor.
- Open the document processor.

Recovery time from Sleep Mode is as follows.

6.0 seconds or less

Note that ambient environmental conditions, such as ventilation, may cause the machine to respond more slowly.

Auto Sleep

Auto Sleep automatically switches the machine into Sleep if left idle for a preset time.

The amount of time before entering Sleep is as follows.

- 1 minutes (default setting)

To change the preset sleep time, refer to the following:

➔ [Configuring Settings Quick Setup Wizard \(page 95\)](#)

Sleep Rules (models for Europe)

You can set whether sleep mode operates for each function. When the machine enters sleep mode, the ID card cannot be recognized.

For more information on Sleep Rules settings, refer to the following:

➔ [Date/Time \(page 421\)](#)

Sleep Level (Energy Saver) (models except for Europe)

Sleep can be switched to two modes: Energy Saver mode and Quick Recovery mode. The default setting is Energy Saver mode.



- Use the Energy Saver mode under normal circumstances. Use the Quick Recovery mode only when the computer does not recognize USB-connected devices. Note that this will consume more power.
 - Energy Saver mode cannot be set when the optional Network Interface Kit is installed.
-

For more information on Sleep Level, refer to the following:

➔ [Configuring Settings Quick Setup Wizard \(page 95\)](#)

Energy Saver Recovery Level

This machine can reduce power consumption when recovering from Energy Saver Mode. For Energy Saver Recovery Level, [Full Recovery], [Normal Recovery] or [Power Saving Recovery] can be selected. The factory default is [Normal Recovery].

For more information on Energy Saver Mode settings, refer to the following:

➔ [Configuring Settings Quick Setup Wizard \(page 95\)](#)

➔ [Energy Saver Recovery Level \(page 424\)](#)

Weekly Timer Settings

Set the machine to automatically sleep and wake up at times specified for each day.

For more information on Weekly Timer Settings, refer to the following:

➔ [Configuring Settings Quick Setup Wizard \(page 95\)](#)

➔ [Weekly Timer Settings \(page 423\)](#)

Power Off Timer (models for Europe)

If the machine is not used while in sleep mode, the power automatically turns off. The Power Off Timer is used to set the time until the power turns off.

The factory setting for the time until the power turns off: 3 days

➔ [Date/Time \(page 421\)](#)

Quick Setup Wizard

The following settings can be configured in a wizard-style screen.

Fax Setup

Configures basic fax settings. This item is displayed only for fax-compatible machines.

➔ FAX Operation Guide

Items	Contents
Dialing/RX Mode	Dialing Type Reception Mode
Local Fax Information	Local Fax Station Name Local Fax Station Number Local Fax ID TTI
Volume	Fax Speaker Volume Fax Monitor Volume Job Finish
Rings	Rings (Normal) Rings (TAD) Rings (Fax/Phone)
Paper Source/Output	Paper Source Settings
Redial	Retry Times
Show Power Off Message	Show Power Off Message

Paper setup

Configure the paper used for printing.

Items	Contents
Cassette	Paper size (Cassette 1 to Cassette 5) Paper type (Cassette 1 to Cassette 5)
Multipurpose Tray	Paper size Paper Type

Energy Saver Setup

Configures sleep mode and low power mode.

Items	Contents
Sleep Mode	Sleep Timer Sleep Level
Recovery Mode	Energy Saver Recovery Level

Items	Contents
Weekly Timer	Weekly Timer Settings Schedule* ¹ Retry* ¹ Retry Times* ¹ Retry Interval* ¹

*¹ This item appears when [Weekly Timer Settings] is set to [On].

Network Setup

Configures network settings.

Items	Contents
Network	Network Selection Wi-fi* ² DHCP* ³ IP Address* ⁴ Subnet Mask* ⁴ Default Gateway* ⁴

*¹ This function is displayed when the optional Wireless Network Interface Kit (IB-37/IB-38) is installed.

*² This function is displayed when Network Selection is set to [Wi-Fi].

*³ This function is displayed when Network Selection is set to [Wired Network].

*⁴ This function is not displayed when DHCP is set to [On].

Email Setup

Set SMTP server name and sender address to enable mail sending.

Items	Contents
Email	SMTP (Email TX) SMTP Server Name* ¹ SMTP Port Number* ¹ Sender Address* ¹

*¹ This function is displayed when SMTP (Email TX) is set to [On].

Security Setup

Specify the security level by Security Quick Setup.

Notification Setup

Set whether the panel notifies that the replacement time for consumables is approaching.

Configuring Settings Quick Setup Wizard

 **NOTE**

If the user authentication screen appears, log in with a user who has the privilege to configure this setting. If you do not know your login user name or password, please contact your administrator.

1 Display the screen.

[System Menu / Counter] key > [Quick SetupWizard]

2 Select a function.

3 Configure the settings.

Start the wizard. Follow the instructions on the screen to configure settings.

 **NOTE**

If you experience difficulty configuring the settings, refer to the following:

→ [Help Screen \(page 74\)](#)

[End]

Exits the wizard. Settings configured so far are applied.

[<< Previous]

Returns to the previous item.

[Skip >>]

Advances to the next item without setting the current item.

[Next >]

Advances to the next screen.

[< Back]

Returns to the previous screen.

[Finish]

Register the settings and exit the wizard.

Installing Software

To use printer function, TWAIN/WIA connection, or network fax function, download and install the required software from Download Center (<https://kyocera.info/>).

Published Software (Windows)

Software	Description	Recommended software
KX DRIVER	This driver enables files on a computer to be printed by the machine. Multiple page description languages (PCL XL, KPDL, etc.) are supported by a single driver. This printer driver allows you to take full advantage of the features of the machine. Use this driver to create PDF files.	○
KPDL mini-driver/PCL minidriver	This is a Microsoft MiniDriver that supports PCL and KPDL. There are some restrictions on the machine features and option features that can be used with this driver.	—
FAX Driver	This makes it possible to send a document created in a computer software application as a fax via the machine.	—
TWAIN Driver	This driver enables scanning on the machine using a TWAIN compliant software application.	○
WIA Driver	WIA (Windows Imaging Acquisition) is a function of Windows that enables reciprocal communication between an imaging device such as a scanner and an image processing software application. An image can be acquired using a WIA-compliant software application, which is convenient when a TWAIN-compliant software application is not installed in the computer.	—
KYOCERA Net Viewer	This is a utility that enables monitoring of the machine on the network.	—
Status Monitor 5	This is a utility that monitors the printer status and provides an ongoing reporting function.	○
File Management Utility	This makes it possible to send and save a scanned document to a specified network folder.	—
KYOCERA Net Direct Print	This makes it possible to print a PDF file without starting Adobe Acrobat/Reader.	—
FONTS	These are display fonts that enable the machine's built-in fonts to be used in a software application.	○
Quick Network Setup Tool	A tool to configure the network (wired LAN) settings of the machine.	—
Wi-Fi Setup Tool	A tool to configure the wireless network (wireless LAN) settings of the machine.	—
Scan to Folder Setup Tool for SMB	A tool for creating shared folders on your PC, setting the created shared folders as destination folders on this machine, and the like.	—



NOTE

- Installation on Windows must be done by a user logged on with administrator privileges.
 - The fax function can be used on products equipped with fax capability.
-

Installing Software in Windows

Downloading and installing from the website

Download and install a software from our website.

1 Download a software from the website.

- 1 Launch your Web browser.
- 2 Enter "<https://kyocera.info/>" into the browser's address bar or location bar.



- 3 Enter and search the product name, and select this product from the candidate list.

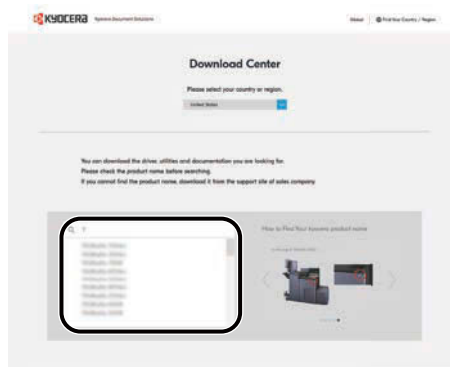

- 4 Change the selected operating system and its language setting as needed.

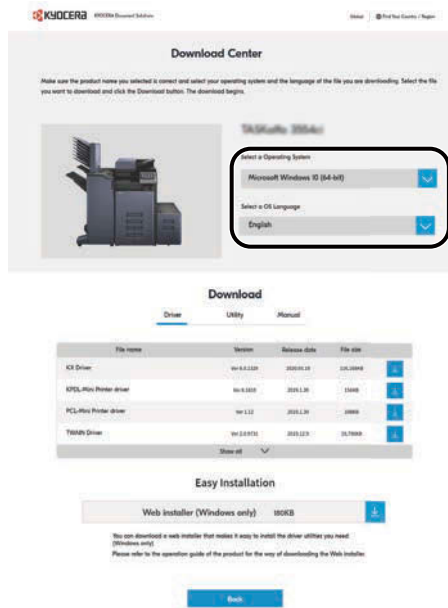

- 5 Driver tab or Utility tab >  of the software you want to download.
An installer of the selected software will be downloaded.

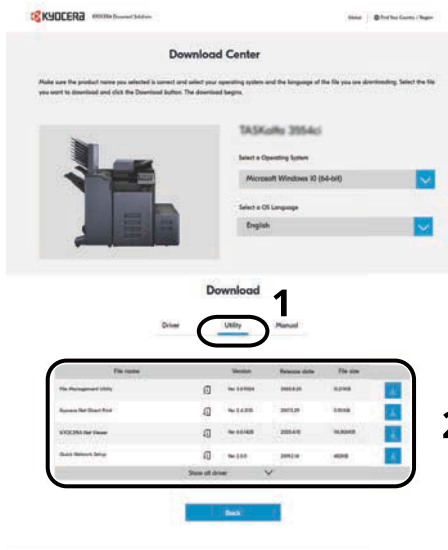

2 Double-click the downloaded installer to launch.

Follow the guidance on the screen to install the software.



NOTE

- Installation on Windows must be done by a user logged on with administrator privileges.
- If the user account management window appears, click [Yes] (Allow).

Using the web installer

Install a software by using a web installer downloaded from our website.

1 Download a software from the website.

- 1 Launch your Web browser.
- 2 Enter "<https://kyocera.info/>" into the browser's address bar or location bar.

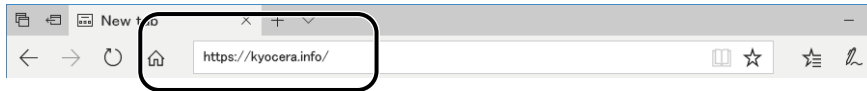

- 3 Enter and search the product name, and select this product from the candidate list.

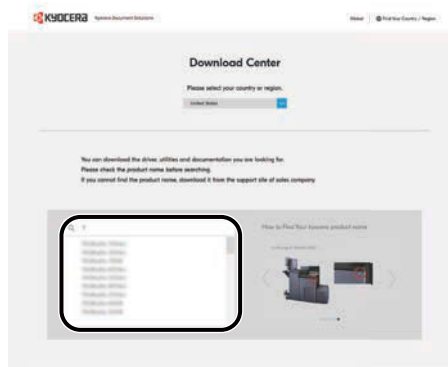

- 4 Change the selected operating system and its language setting as needed.

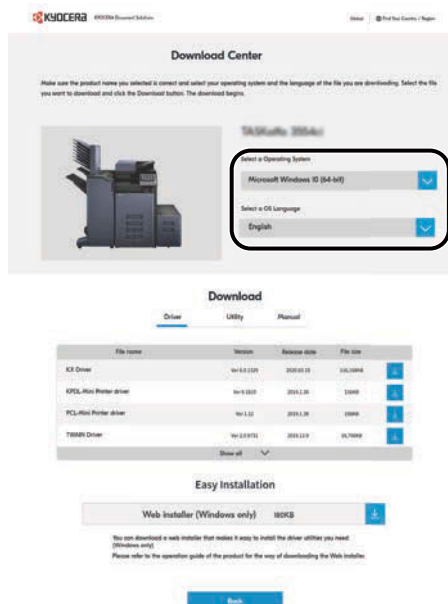

- Utility tab >  of "Web installer".
A web installer will be downloaded.

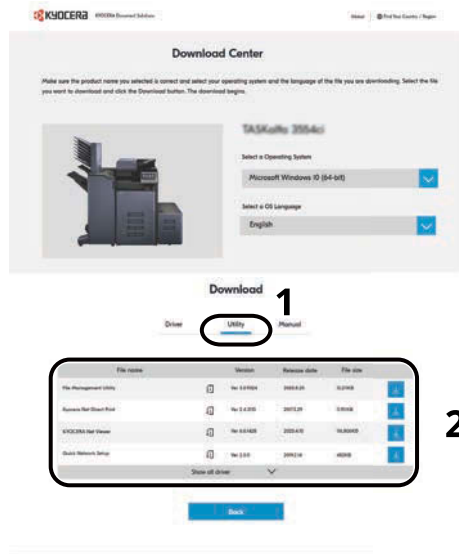

2 Double-click the downloaded installer to launch.



NOTE

- Installation on Windows must be done by a user logged on with administrator privileges.
- If the user account management window appears, click [Yes] (Allow).

3 Display the screen.

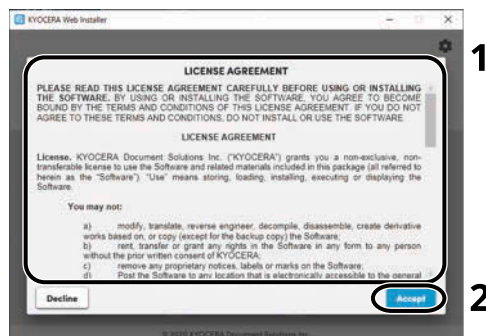

- 1 Read the license agreement.
- 2 Click [Accept] if there is no problem.

4 Click [Install].

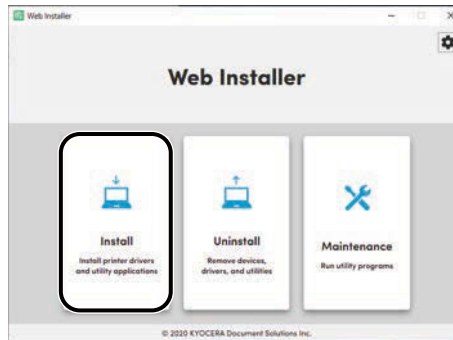

5 Select a model and click [Next].

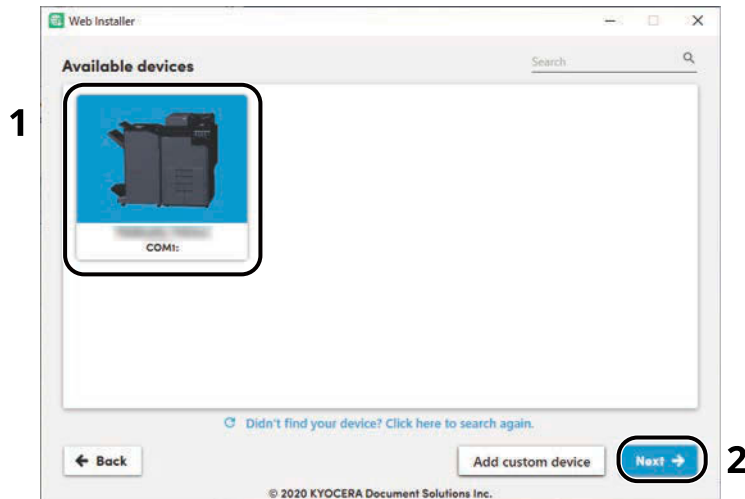

NOTE

- The machine cannot be detected unless it is on. If the computer fails to detect the machine, verify that it is connected to the computer via a network or USB cable.
- If a desired device is not displayed, select [Add custom device] to directly select the device you want to use.

6 Install the software.

- 1 Select software you want to install.

NOTE

Software recommended to install have in their checkboxes by default. Change as required.

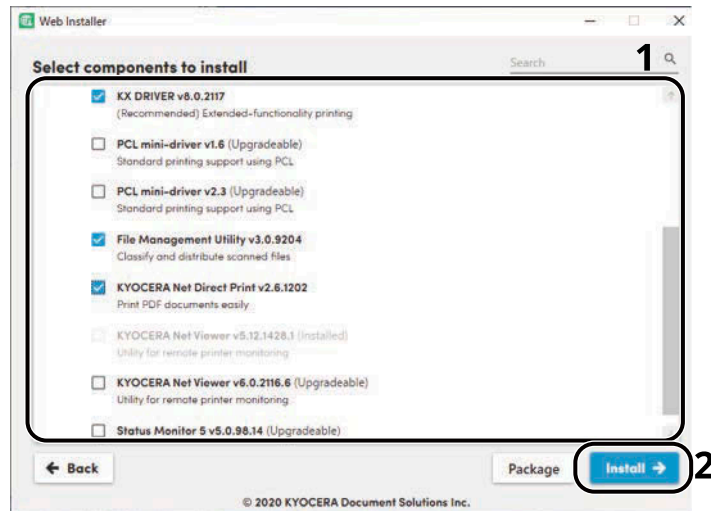

2 Click [Install].

When [Install] is clicked, a screen which asks for cooperation for data collection may appear. Select one of the answer choices and click [OK].

 **NOTE**

- If the Windows security window appears, click [Install this driver software anyway].
- To install Status Monitor for Windows 8.1, it is necessary to install Microsoft.NET Framework 4.0 beforehand.

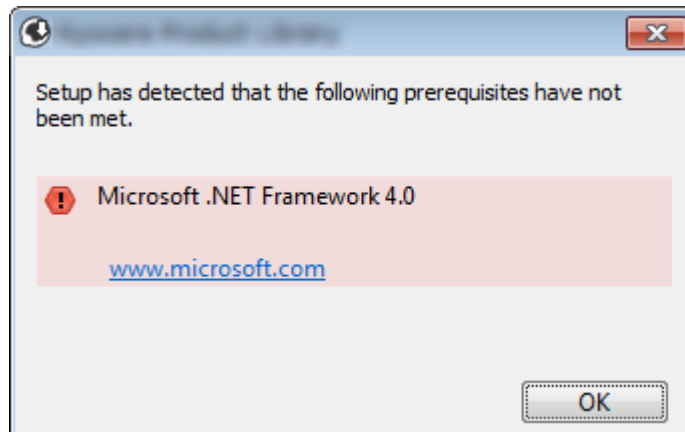

7 Finish the installation.

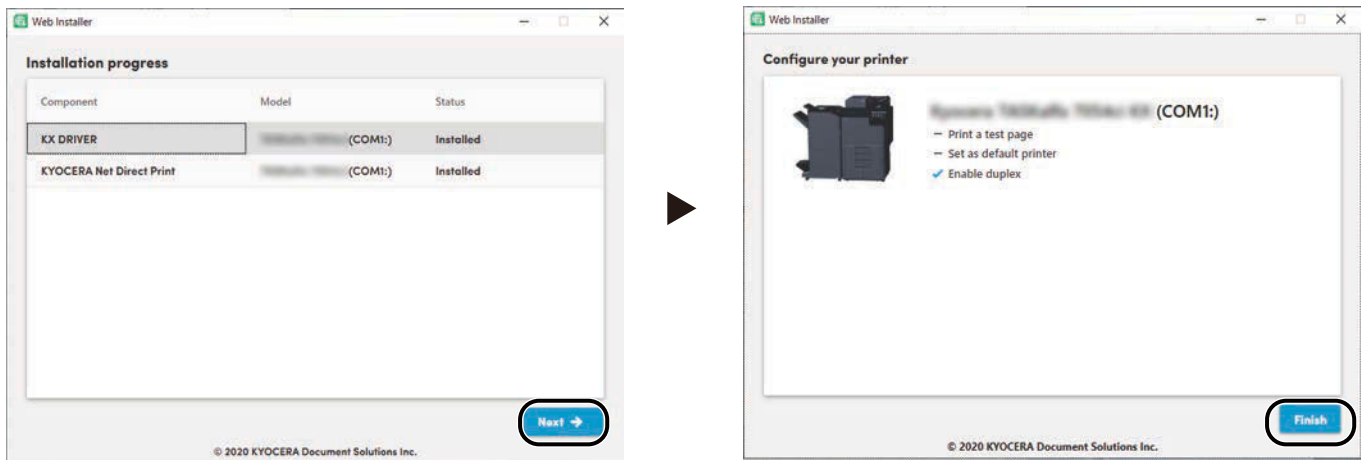

Click [Next] > [Finish] to finish the installation wizard.

If a system restart message appears, restart the computer by following the screen prompts. This completes the printer driver installation procedure.

If you are installing the TWAIN driver, continue by configuring the following:

➔ [Setting TWAIN Driver \(page 112\)](#)

Uninstalling Windows Software

Use a web installer to uninstall software. The web installer can be downloaded from the Download Center (<https://kyocera.info/>).

NOTE

For details on how to download the web installer, refer to the following:

➔ [Using the web installer \(page 100\)](#)

1 Double-click the downloaded installer to launch.

NOTE

Uninstallation on Windows must be done by a user logged on with administrator privileges.

2 Display the screen.

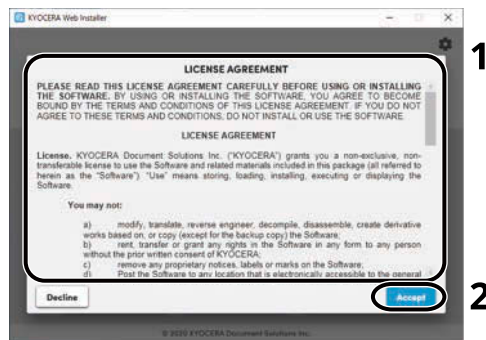

- 1 Read the license agreement.
- 2 Click [Accept] if there is no problem.

3 Click [Uninstall].

4 Uninstall the software.

- 1 Select software you want to uninstall.

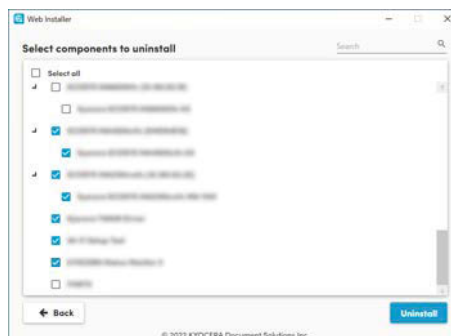

- 2 Click [Uninstall].

5 Finish uninstalling.

Click [Finish].

Restart the system for the uninstall to take effect.

Installing Software on a Mac OS Computer

A printer driver can be installed for a Macintosh computer.

NOTE

- Installation on Mac OS must be done by a user logged on with administrator privileges.
- When installing for a Mac, set the machine's emulation to [KPD/L] or [KPD/L (Auto)].
 - ➔ [Printer \(page 466\)](#)
- If connecting by Bonjour, enable Bonjour in the machine's network settings.
 - ➔ [Bonjour \(page 494\)](#)
- In the Authenticate screen, enter the name and password used to log in to the operating system.
- When printing via AirPrint, you do not have to install the software.

1 Download a software from the website.

- 1 Launch your Web browser.
- 2 Enter "<https://kyocera.info/>" into the address bar.

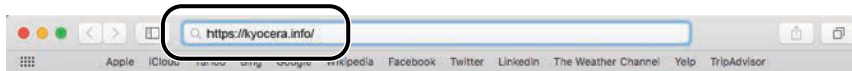

- 3 Enter and search the product name, and select this product from the candidate list.

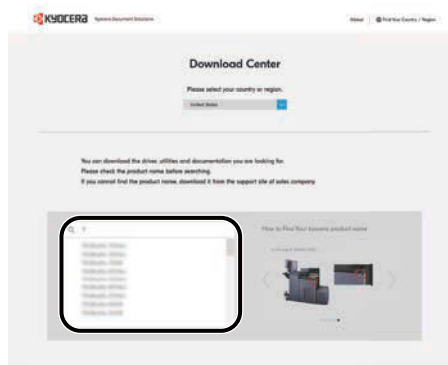

- 4 Change the selected operating system and its language setting as needed.

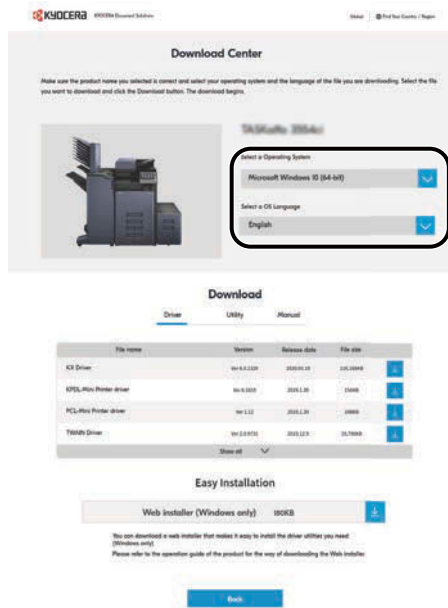

- 5 Driver tab > "Mac Printer Driver (x.x and later)"  An installer of the selected software will be downloaded.

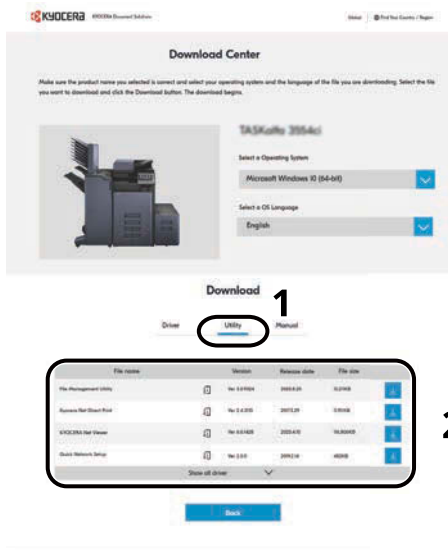

2 Install the Printer Driver.

Double click to launch the downloaded installer.

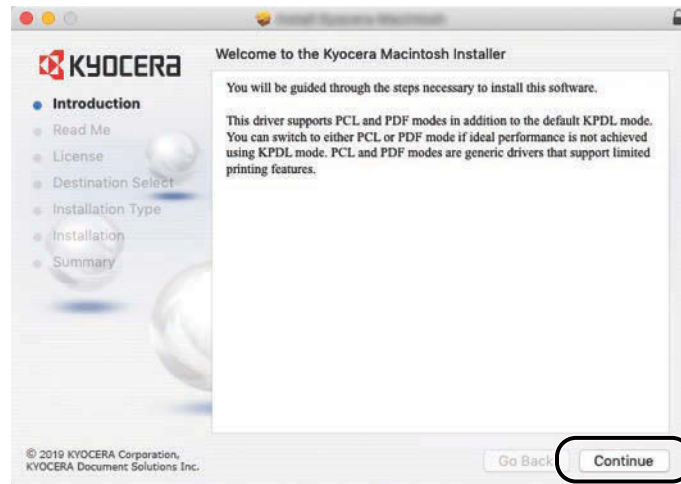

Install the printer driver as directed by the instructions in the installation software. This completes the printer driver installation.

If a USB connection is used, the machine is automatically recognized and connected. If an IP connection is used, the settings below are required.

3 Configure the printer.

- 1 Open System Preferences and add the printer.

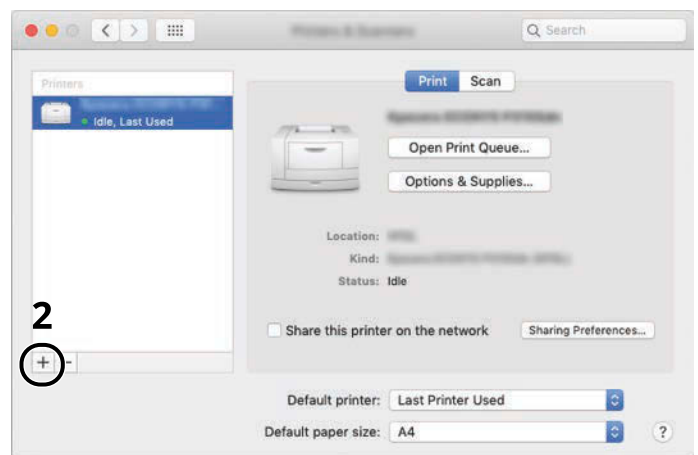
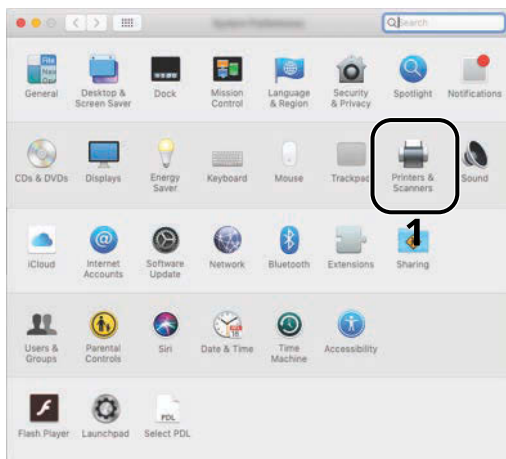

- 2 Select [Default] and click the item that appears in "Name" and then select the driver in Use.

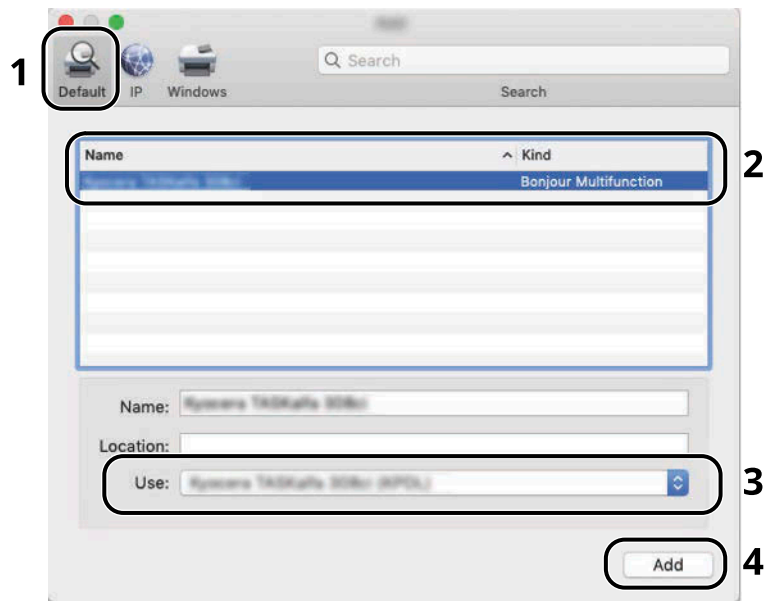

The selected machine is added.

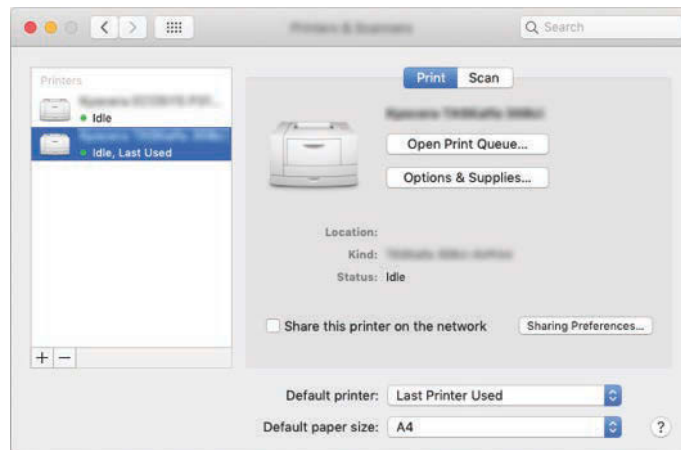

 **NOTE**

When using an IP connection, click the IP icon for an IP connection and then enter the host name or IP address. The number entered in "Address" will automatically appear in "Name". Change as required.

3 Select the options equipped with the machine.

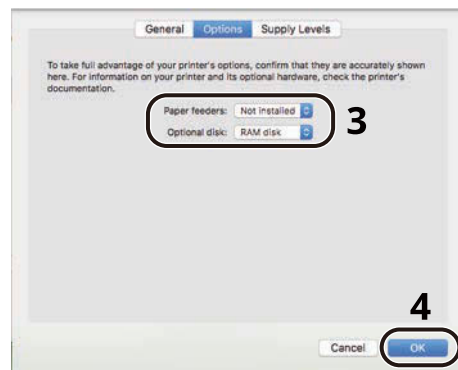
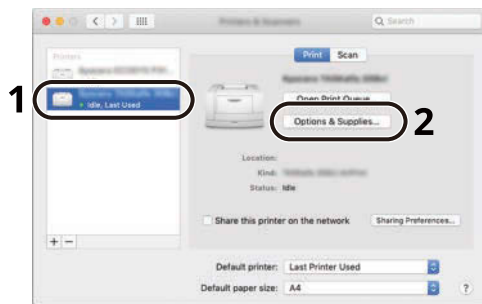

Setting TWAIN Driver

Register this machine to the TWAIN Driver. Instructions are based on interface elements as they appear in Windows 10.

1 Display the screen.

- 1 Click search box in the taskbar, and enter "TWAIN Driver Setting" in the search box. Select [TWAIN Driver Setting] in the search list. TWAIN Driver Settings screen is displayed.

NOTE

In Windows 8.1, click [Search] in the Charms Bar, and enter "TWAIN Driver Setting" in the search box.

- 2 Click [Add].



2 Configure TWAIN Driver.

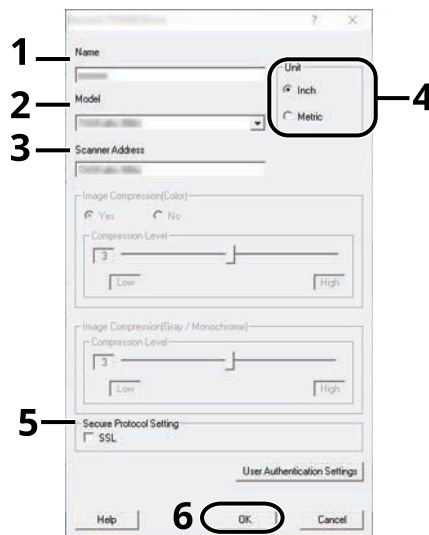

- 1 Enter the machine name.
- 2 Select this machine from the list.
- 3 Enter the machine's IP addresses or host name.
- 4 Set units of measurement.

- 5 When using SSL, select the checkbox beside SSL.
- 6 Click [OK].

 **NOTE**

When the machine's IP address or host name is unknown, contact Administrator.

3 Finish registering.

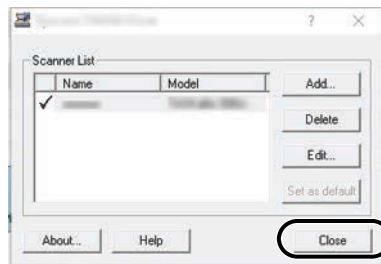

 **NOTE**

Click [Delete] to delete the added machine. Click [Edit] to change names.

Setting WIA Driver

Register this machine to the WIA Driver. Instructions are based on interface elements as they appear in Windows 10.

1 Display the screen.

- 1 Click search box in taskbar, and enter "View scanners and cameras" in the search box. Select [View scanners and cameras] in the search list then the Scanners and Cameras screen is displayed.



NOTE

- For Windows 11, select the [Start] button → [All apps]→ [Windows Tools]→ [Control Panel]. Enter "Scanner" into the search field on the control panel. Select [View scanners and cameras] in the search list then the Scanners and Cameras screen appears.
- In Windows 8.1, click [Search] in the Charms Bar on Desktop, and enter "View scanners and cameras" in the search box. Click [View scanners and cameras] in the search list then the Scanners and Cameras screen appears.

- 2 Select the same name as this machine from WIA Drivers and press [Properties].

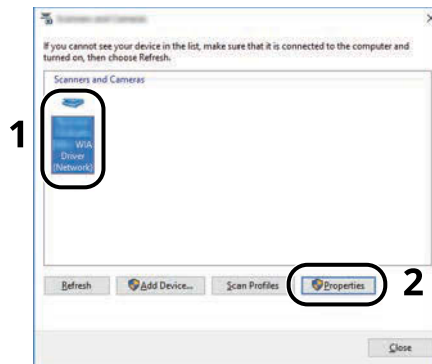

2 Configure WIA Driver.

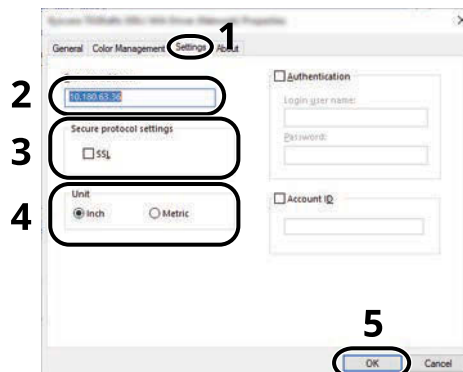

- 1 Click the [Settings] tab.
- 2 Enter the machine's IP addresses or host name.
- 3 When using SSL, select the checkbox beside SSL.

- 4 Set units of measurement.
- 5 Click [OK].

Checking the Counter

Check the number of sheets printed and scanned.

1 Display the screen.

[Home] key > [...] > [Counter]

2 Check the counter

Additional Preparations for the Administrator

Administrator Privileges Overview

This machine is shipped with two default users registered one with Machine Administrator privileges, and another with Administrator privileges. The user with Machine Administrator privileges and the user with Administrator privileges can configure important settings for the machine. The differences in the privileges are as follows:

User with Machine Administrator privileges

This user can configure the product's network settings, security settings such as user registration, and the machine's security level.

➔ [Security Level \(page 504\)](#)

User with Administrator privileges

This user can configure the product's network settings, and security settings such as user registration. This user cannot set the machine's security level.

Log in as Machine Administrator or Administrator

The user with Machine Administrator privileges or the user with Administrator privileges must log in to configure important settings for the product, such as network settings and security settings. The factory default login user name and login password are set as shown below.

Machine Administrator

User Name	DeviceAdmin
Login User Name	TASKalfa MA4500ci:4500, TASKalfa MA3500ci:3500
Login Password	TASKalfa MA4500ci:4500, TASKalfa MA3500ci:3500

Administrator

User Name	Admin
Login User Name	Admin
Login Password	xxxxxxxxxx (Serial Number) ➔ Checking the Equipment's Serial Number (page 2)

IMPORTANT

To ensure security, be sure to change the factory default user name, login user name, and login password. Also, change your password regularly.

➔ [Changing User Properties \(page 527\)](#)

Strengthening the Security

This machine is shipped with two default users registered one with Machine Administrator rights, and another with Administrator rights. Logging in as this user will allow you to configure all settings; therefore, please change the login user name and password.

In addition, this machine is equipped with user authentication function, which can be configured to limit the access to this machine to only those who have a registered login name and password. For details, refer to the following:

➔ [User Authentication and Accounting \(User Login, Job Accounting\) \(page 518\)](#)

NOTE

This product is equipped with the security chip called TPM (Trusted Platform Module). The encryption key used to encrypt confidential information on this machine is stored in a dedicated storage area on the TPM chip. Since this storage area cannot be read from outside the TPM, confidential information can be safely protected.

Restrict the users of the machine.

- User Login
 - ➔ [Overview of User Login Administration \(page 519\)](#)
- Authentication Security
 - ➔ [Authentication Security \(page 522\)](#)
- Auto Panel Reset
 - ➔ [Auto Panel Reset \(page 422\)](#)
- ID Card Settings

The optional IC Card Authentication Kit is required.

 - ➔ [ID Card Settings \(page 547\)](#)

Restrict the basic functions that can be used.

- Local Authorization
 - ➔ [Local Authorization \(page 534\)](#)
- Group Authorization Set
 - ➔ [Group Authorization Settings \(page 537\)](#)
- Guest Authorization Set
 - ➔ [Guest Authorization Settings \(page 540\)](#)

Prevent another user from handling the documents stored in the machine.

- Custom Box

Requires the optional SSD.

 - ➔ [What is Custom Box? \(page 276\)](#)

Output the document stored in the machine at the time when user operates the device via operation panel.

- Remote Printing
 - ➔ [Remote Printing \(page 469\)](#)

Prevent the data stored in the machine from being leaked.

- Data Overwrite
Requires the optional SSD.
It is necessary to activate the Data Security Function.
➔ **Data Encryption / Overwrite Operation Guide**
- Encryption
Requires the optional SSD.
It is necessary to activate the Data Security Function.
➔ **Data Encryption / Overwrite Operation Guide**
- PDF Encryption Functions
➔ [PDF Encryption Functions \(page 377\)](#)

Completely delete the data on the machine before disposing of the machine.

- Data Sanitization
➔ [Data Sanitization \(page 506\)](#)

Protect the transmission from interception and wiretapping.

- IPP over TLS
➔ [IPP over TLS \(page 490\)](#)
- HTTPS
➔ [HTTPS \(page 490\)](#)
- LDAP Security
➔ **Command Center RX User Guide**
- SMTP Security
➔ [SMTP \(Email TX\) \(page 488\)](#)
- POP3 Security
➔ [POP3 \(Email RX\) \(page 488\)](#)
- FTP Encrypted TX
➔ [FTP Encrypted TX \(page 386\)](#)
- Enhanced WSD (TLS)
➔ [Enhanced WSD over TLS \(page 492\)](#)
- IPSec
➔ [IPSec \(page 495\)](#)
- SNMPv3
➔ [SNMPv3 \(page 491\)](#)

Verify the software in the machine.

- Software Verification
➔ [Software Verification \(page 505\)](#)

Preventing from execution of the unauthorized programs

- Allowlisting
 - ➔ [Allowlisting \(page 505\)](#)

Command Center RX

If the machine is connected to the network, you can configure various settings using Command Center RX. This section explains how to access Command Center RX, and how to change security settings and the host name.

→ Command Center RX User Guide

NOTE

To fully access the features of the Command Center RX pages, you must enter the user name and password and log in. Entering the predefined administrator password allows the user to access all pages, including Document Box, Address Book, and Settings on the navigation menu.

Settings that the administrator and general users can configure in Command Center RX are as follows.

Setting	Description	Administrator	General User
Device Information/ Remote Operation	The machine's structure can be checked.	Yes	Yes
Job Status	Displays all device information, including print and scan jobs, storing jobs, scheduled jobs, and job log history.	Yes	Yes
Document Box	Add or delete document boxes, or delete documents within a document box. The logged in user may not be able to configure some settings, depending on the privilege of the user.	Yes	Yes
Address Book	Create, edit, or delete addresses and address groups. The logged in user may not be able to configure some settings, depending on the privilege of the user.	Yes	Yes
Device Settings	Configure the advanced settings of the machine.	Yes	No
Function Settings	Configure the advanced function settings.	Yes	No
Network Settings	Configure the network advanced settings.	Yes	No
Security Settings	Configure the security advanced settings.	Yes	No
Management Settings	Configure the advanced management settings.	Yes	No

NOTE

The fax function can be used on products equipped with fax capability. Here, information on the FAX settings has been omitted.

→ FAX Operation Guide

Accessing Command Center RX

1 Display the screen.

- 1 Launch your Web browser.
- 2 In the address or location bar, enter the machine's IP address or the host name.
Click in the following order to check the machine's IP address and the host name.
[DeviceInformation] in the home screen > [Identification/Wired Network]
Example: https://10.180.81.1 (in the case of /IP address)
https://MFP001 (if the host name is MFP001)

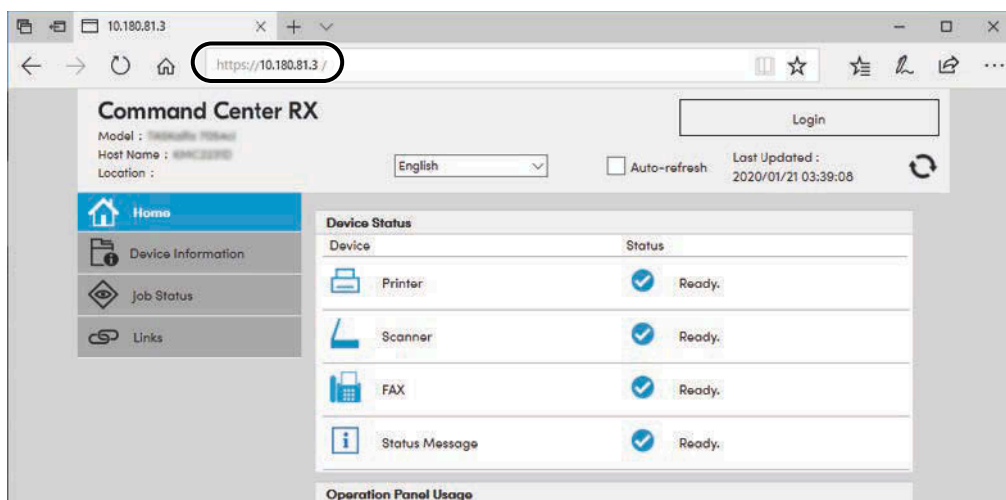

The web page displays basic information about the machine and Command Center RX as well as their current status.

NOTE

If the screen "There is a problem with this website's security certificate." is displayed, configure the certificate.

Command Center RX User Guide

You can also continue the operation without configuring the certificate.

2 Configure the settings.

Select a category from the navigation bar on the left of the screen.

NOTE

To fully access the features of the Command Center RX pages, you must enter the user name and password and log in. Entering the predefined administrator password allows the user to access all pages, including Document Box, Address Book, and Settings on the navigation menu.

Changing Security Settings

1 Display the screen.

- 1 Launch your Web browser.
- 2 In the address or location bar, enter the machine's IP address or the host name.
Click in the following order to check the machine's IP address and the host name.
[DeviceInformation] in the home screen > [Identification/Wired Network]
- 3 Log in with administrator privileges.

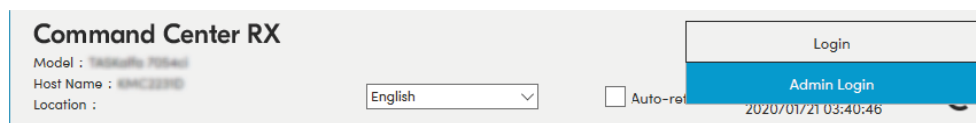

- 4 Click [Security Settings].

2 Configure the settings.

From the [Security Settings] menu, select the setting you want to configure.

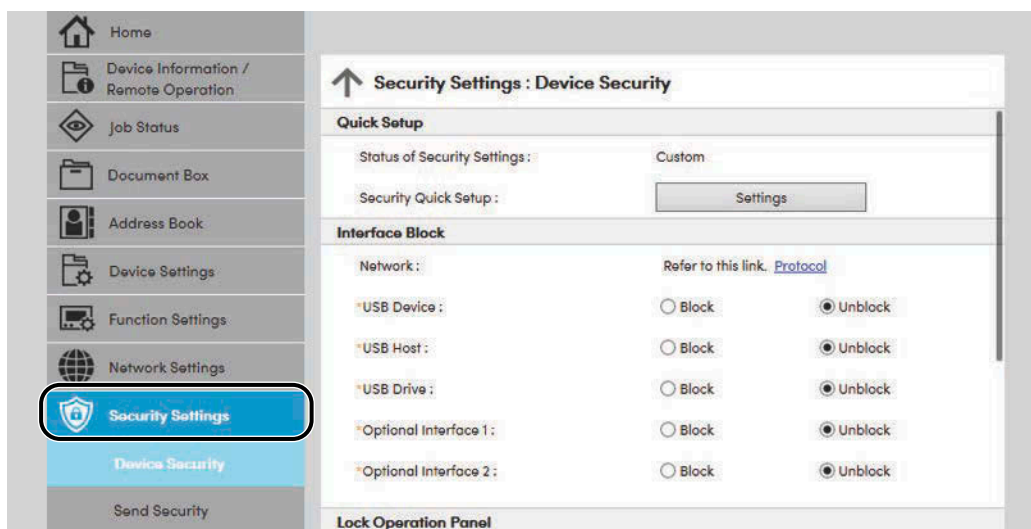

NOTE

For details on settings related to certificates, refer to the following:

➔ [Command Center RX User Guide](#)

Changing Device Information

1 Display the screen.

- 1 Launch your Web browser.
- 2 In the address or location bar, enter the machine's IP address or the host name.
Click in the following order to check the machine's IP address and the host name.
[DeviceInformation] in the home screen > [Identification/Wired Network]
- 3 Log in with administrator privileges.

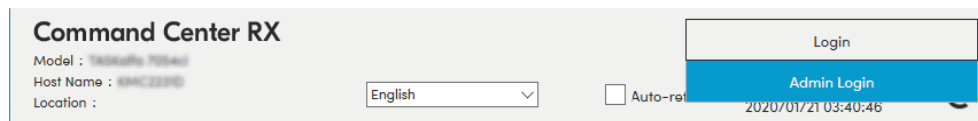

- 4 Click [System] from the [Device Settings] menu.

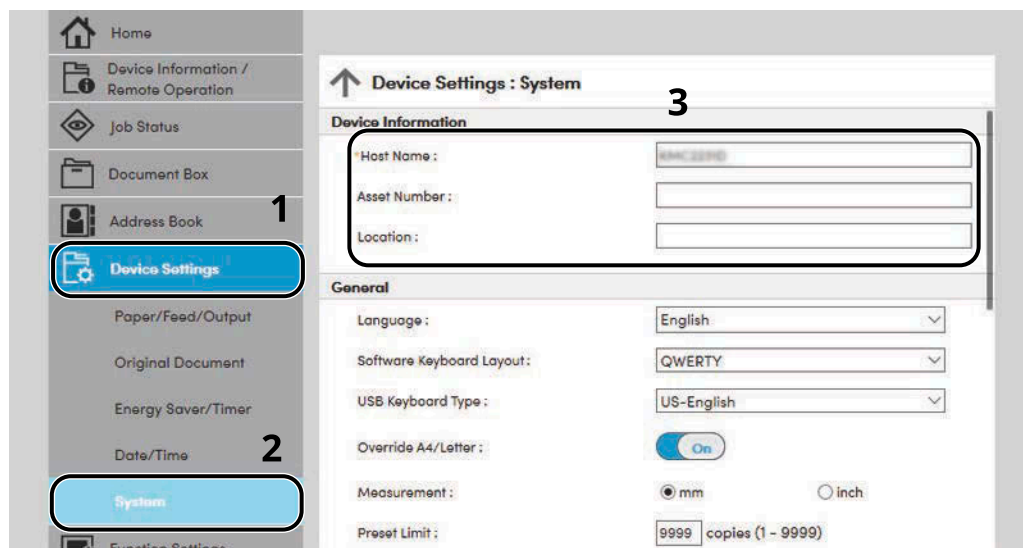

2 Specify the host name.

Enter the device information, and then click [Submit].

✓ IMPORTANT

After changing the setting, restart the network or turn the machine OFF and then ON. To restart the network interface card, click [Reset] in the [Management Settings] menu, and then click [Restart Network] in "Restart".

SMTP and E-mail Settings

By configuring the SMTP settings, it is possible to send the images scanned by the machine as E-mail attachments and to send E-mail notices when jobs have been completed. To use this function, this machine must be connected to a mail server using the SMTP protocol.

In addition, configure the following.

SMTP settings

"SMTP Protocol" and "SMTP Server Name" in "SMTP"

The sender address when the machine sends E-mails

"Sender Address" in "E-mail Send Settings"

The setting to limit the size of E-mails

"E-mail Size Limit" in "E-mail Send Settings"

The procedure for specifying the SMTP settings is explained below.

1 Display the screen.

Display the SMTP Protocol screen.

- 1 Launch your Web browser.
- 2 In the address or location bar, enter the machine's IP address or the host name.
Click in the following order to check the machine's IP address and the host name.
[DeviceInformation] in the home screen > [Identification/Wired Network]
- 3 Log in with administrator privileges.

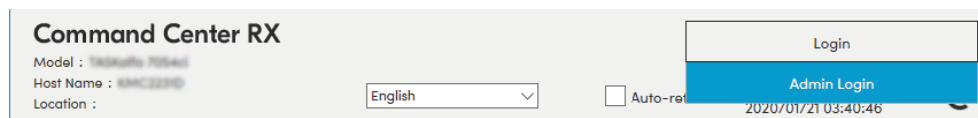

4 Click [Protocol] from the [Network Settings] menu.

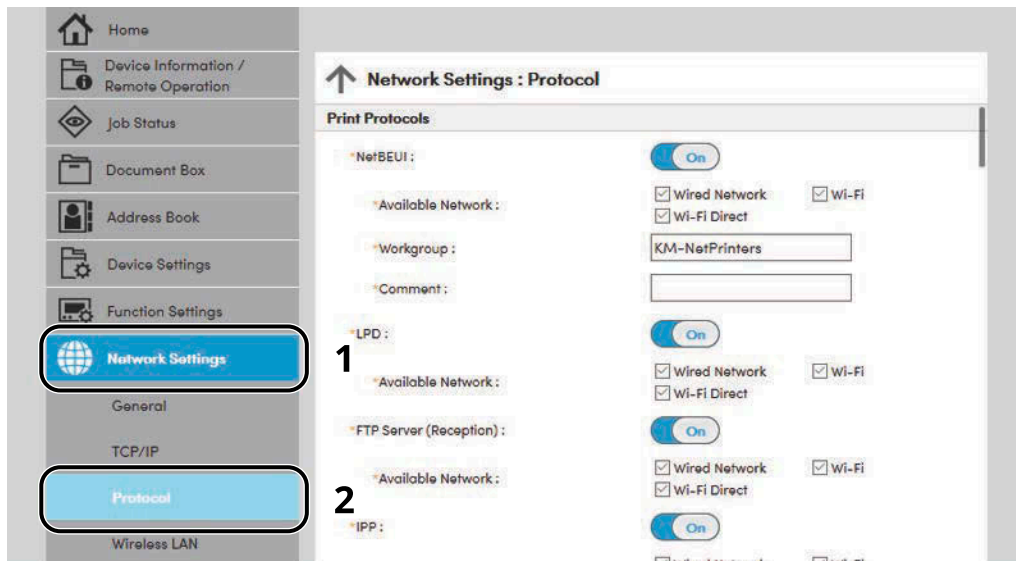

2 Configure the settings.

Set "SMTP (E-mail TX)" to [On] in the "Send Protocols".

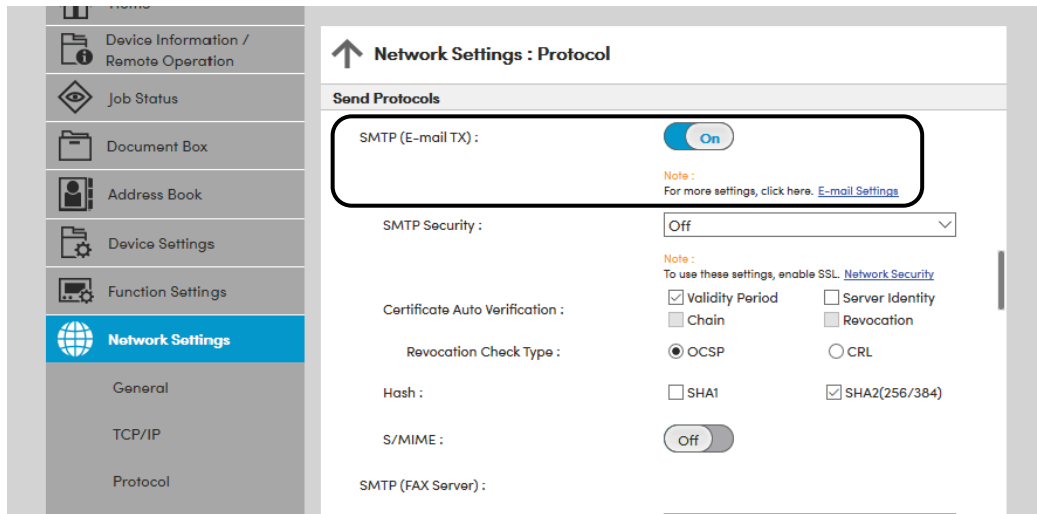

3 Display the screen.

Display the E-mail Settings screen.

Click [E-mail] from the [Function Settings] menu.

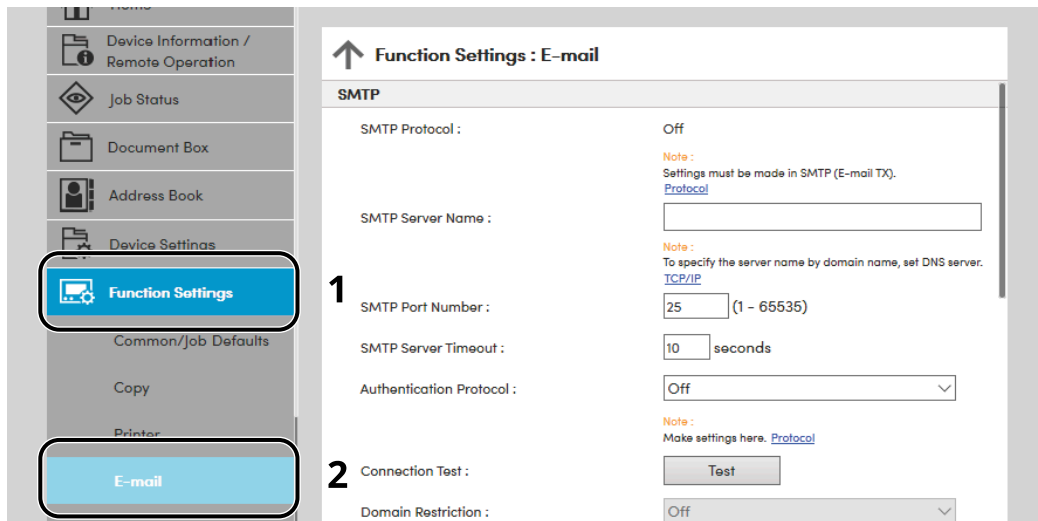

4 Configure the settings.

Enter "SMTP" and "E-mail Send Settings" items.

SMTP

Set to send e-mail from the machine.

[SMTP Protocol]

Displays the SMTP protocol settings. Check that [SMTP Protocol] is set to [On]. If [Off] is set, click [Protocols] and set the SMTP protocol to [On].

[SMTP Server Name]

Enter the host name or IP address of the SMTP server. Be sure to enter the items.

[SMTP Port Number]

Specify the port number to be used for SMTP. The default port number is 25.

[SMTP Server Timeout]

Set the amount of time to wait before time-out in seconds.

[Authentication Protocol]

To use SMTP authentication, enter the user information for authentication.

[SMTP Security]

Set SMTP security. Set [SMTP Security] of "SMTP (E-mail TX)" on the "Protocols" page.

[Connection Test]

Tests to confirm the proper operation under the settings without sending an email.

[Domain Restrictions]

To restrict the domains, click the [Domain List] and enter the domain names of addresses to be allowed or rejected. Restriction can also be specified by e-mail address.

POP3

You don't need to set the items when you only use the function of sending e-mail from the machine. Set the items if you want to enable the function of receiving e-mail on the machine.

➔ **Command Center RX User Guide**

E-mail Send Settings

[E-mail Size Limit]

Enter the maximum size of E-mail that can be sent in kilobytes. When E-mail size is greater than this value, an error message appears and E-mail sending is canceled. Use this setting if you have set E-mail Size Limit for SMTP server. If not, enter a value of 0 (zero) to enable E-mail sending regardless of the size limit.

[Sender Address]

Specify the sender address for when the machine sends E-mails, such as the machine administrator, so that a reply or non-delivery report will go to a person rather than to the machine. The sender address must be entered correctly for SMTP authentication. The maximum length of the sender address is 256 characters. Be sure to enter the items.

[Signature]

Enter the signature. The signature is free form text that will appear at the end of the E-mail body. It is often used for further identification of the machine. The maximum length of the signature is 512 characters.

[Function Default]

Change the function default settings in [Customize Status Display] page.

5 Click [Submit].

Registering Destinations

1 Display the screen.

- 1 Launch your Web browser.
- 2 In the address or location bar, enter the machine's IP address or the host name.
Click in the following order to check the machine's IP address and the host name.
[DeviceInformation] in the home screen > [Identification/Wired Network]
- 3 Log in with administrator privileges.

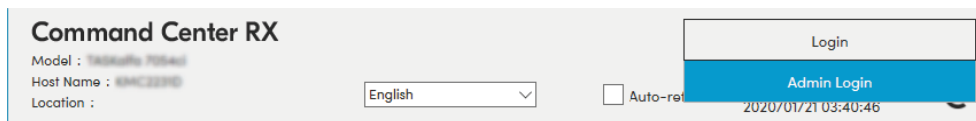

- 4 In the [Address Book] menu, click [Machine Address Book].

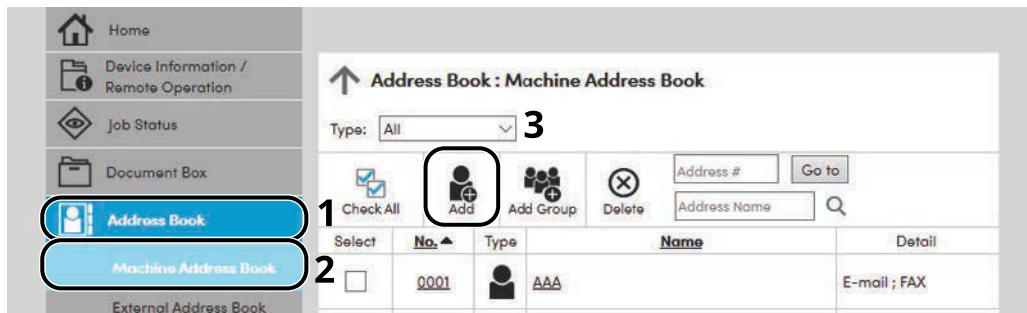

- 5 Click [Add].

2 Populate the fields.

- 1 Enter the destination information.
Enter the information for the destination you want to register. The fields to populate are the same as when registering via operation panel.
➔ [Registering Destinations in the Address Book \(page 173\)](#)
- 2 Click [Submit].

Creating a New Custom Box

NOTE

An optional SSD is required to use the Custom Box.

1 Display the screen.

- 1 Launch your Web browser.
- 2 In the address or location bar, enter the machine's IP address or the host name.
Click in the following order to check the machine's IP address and the host name.
[DeviceInformation] in the home screen > [Identification/Wired Network]
- 3 In the [Document Box] menu, click [Custom Box].

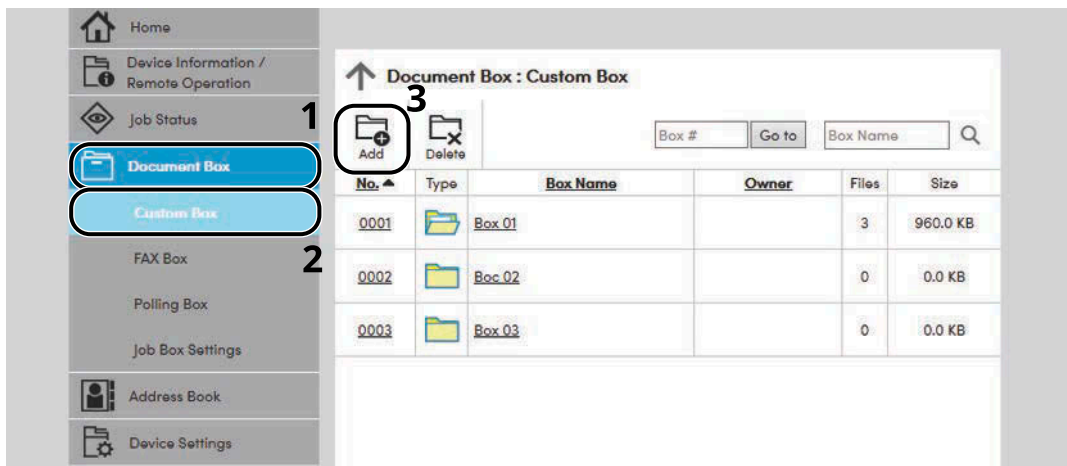

- 4 Click [Add].

2 Configure the Custom Box.

- 1 Enter the box details.
Enter the information for the custom box you want to register. For details on the fields to populate, refer to the following:
 - ➔ **Command Center RX User Guide**
- 2 Click [Submit].

Printing a Document Stored in a Custom Box

1 Display the screen.

- 1 Launch your Web browser.
- 2 In the address or location bar, enter the machine's IP address or the host name.
Click in the following order to check the machine's IP address and the host name.
[DeviceInformation] in the home screen > [Identification/Wired Network]
- 3 In the [Document Box] menu, click [Custom Box].

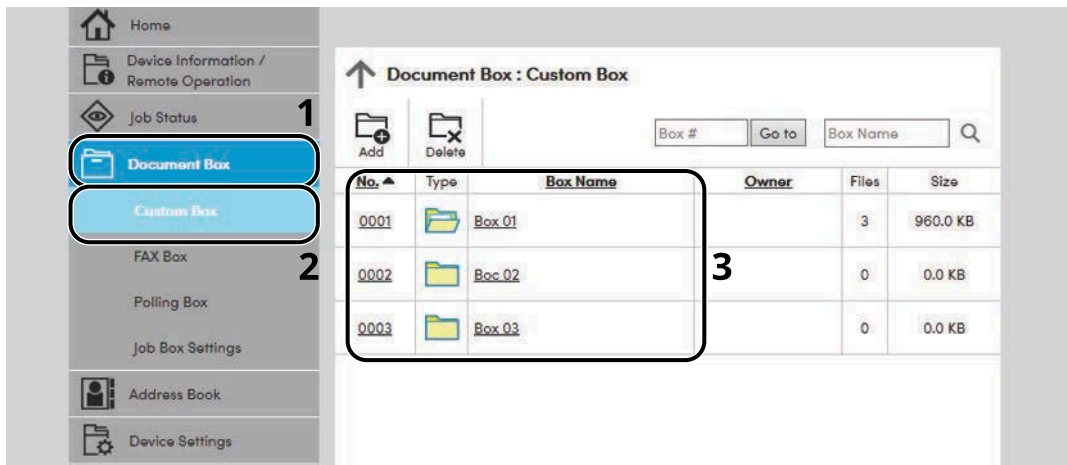

- 4 Click the number or name of the Custom Box in which the document is stored.

2 Print the document.

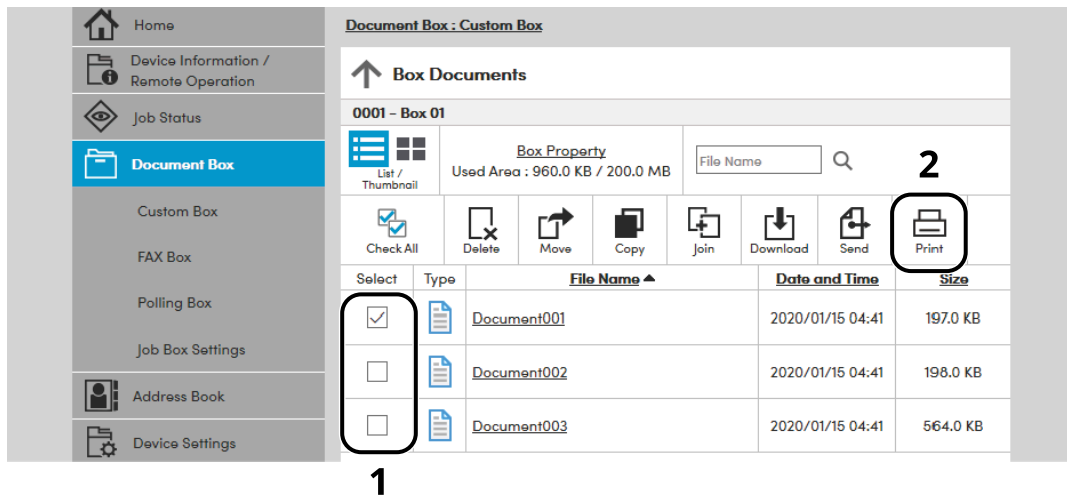

- 1 Select the document you wish to print.
Select the checkbox of the document to be printed.
- 2 Click [Print].
- 3 Configure settings for printing, click [Print].

Transferring Data from Our Other Products

By using the machine's utility, you can smoothly migrate address books when the machine is to be replaced. This section explains how to transfer data between our products.

Migrating the Address Book

The Address Book registered on the machine can be backed up or migrated using the KYOCERA Net Viewer downloaded from Download Center (<https://kyocera.info/>).

For details on KYOCERA Net Viewer operation, refer to the following:

➔ [KYOCERA Net Viewer User Guide](#)

Backing up Address Book Data to PC

1 Start up KYOCERA Net Viewer.

2 Create a backup.

- 1 Right-click on the name of the model from which you want to back up the Address Book, and select [Advanced] > [Set multiple devices].

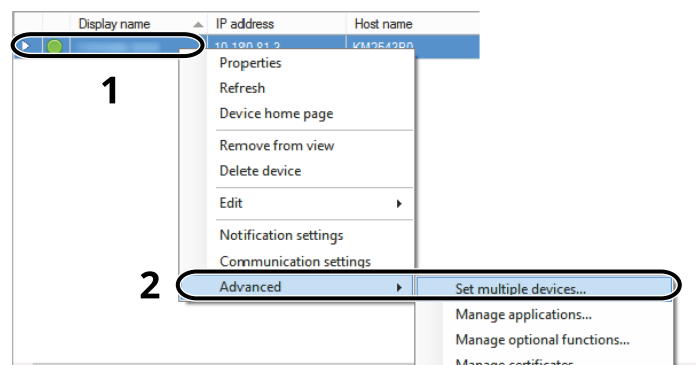

- 2 Select [Custom Mode] and click [Next].

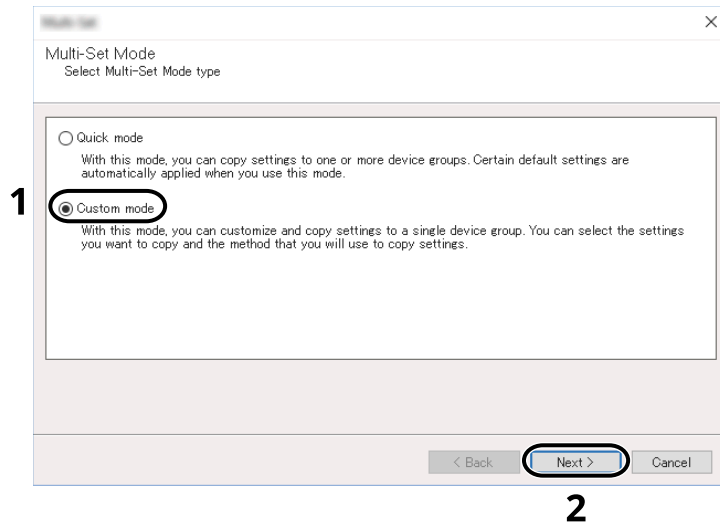

- 3 Select destination device group and click [Next].

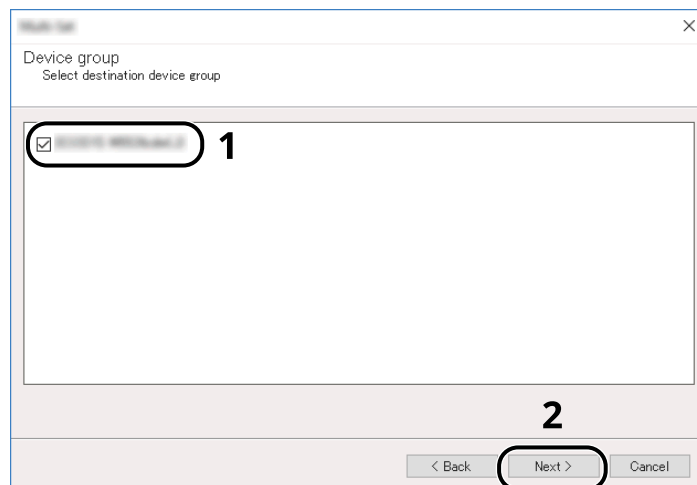

- 4 Select [Device Address Book] and click [Next].

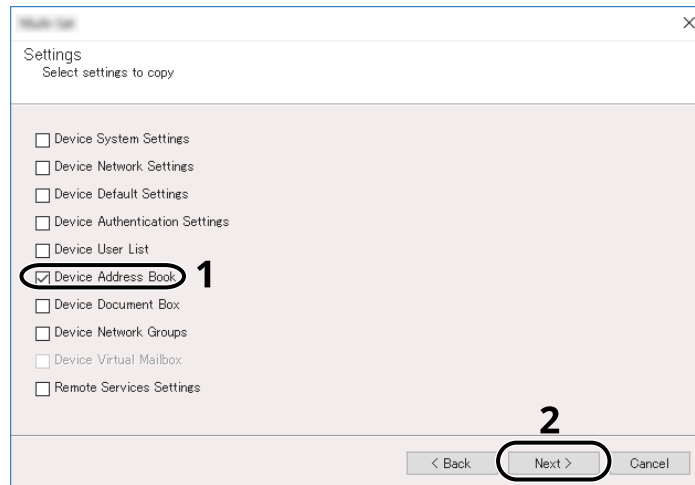

- 5 Select [Create from device] and remove the checkmark from [Overwrite settings on target device], and then click [Next].

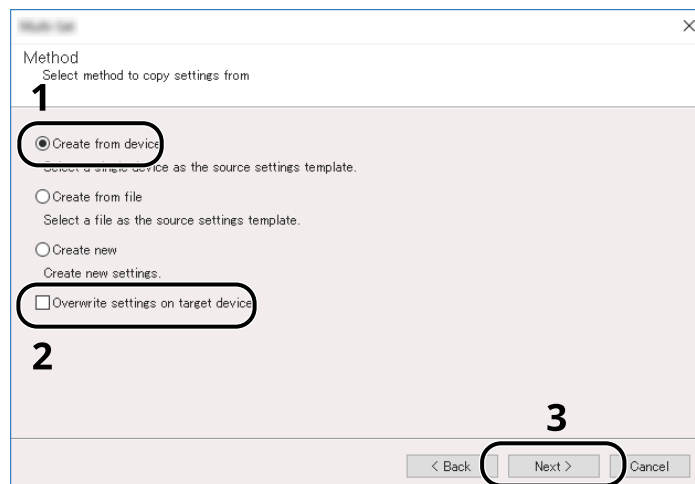

- 6 Select the model you want to back up, and click [Next].

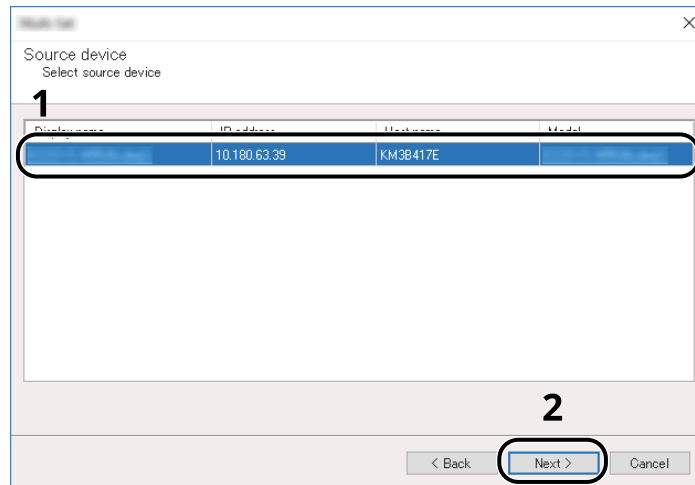

 **NOTE**

If the "Admin Login" screen appears, enter the administrator's login user name and password, and then click [OK].

- 7 Click on [Save to file].

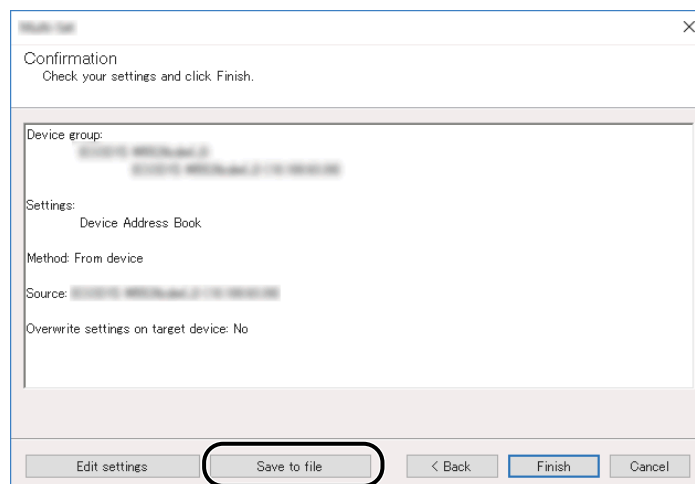

- 8 Specify the location to save the file, enter the file name, and then click [Save].
For "Save as type", make sure to select "XML File".

- 9 After saving the file, always click [Cancel] to close the screen.

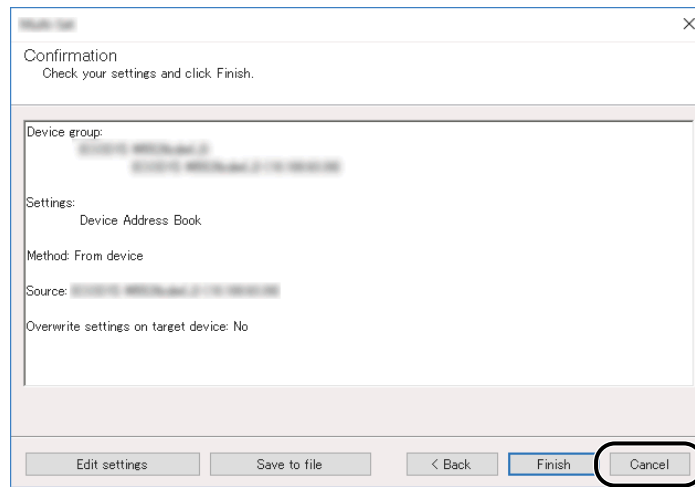

Please note that selecting [Finish] will write the data to the machine's Address Book.

Writing Address Book Data to the Machine

- 1 Start up KYOCERA Net Viewer.

- 2 Load the Address Book data.

- 1 Right-click on the model name to which you want to transfer the Address Book, and select [Advanced] - [Set multiple devices].

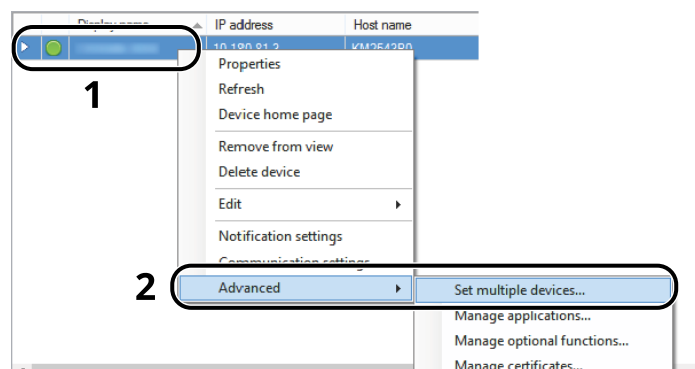

- 2 Select [Custom Mode] and click [Next].

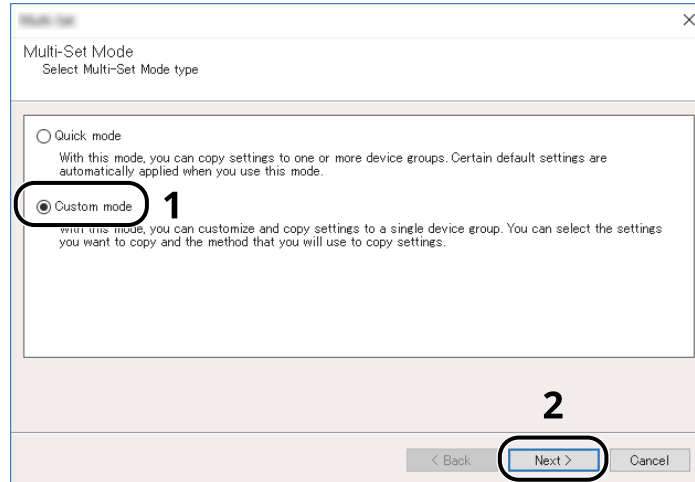

- 3 Select destination device group and click [Next].

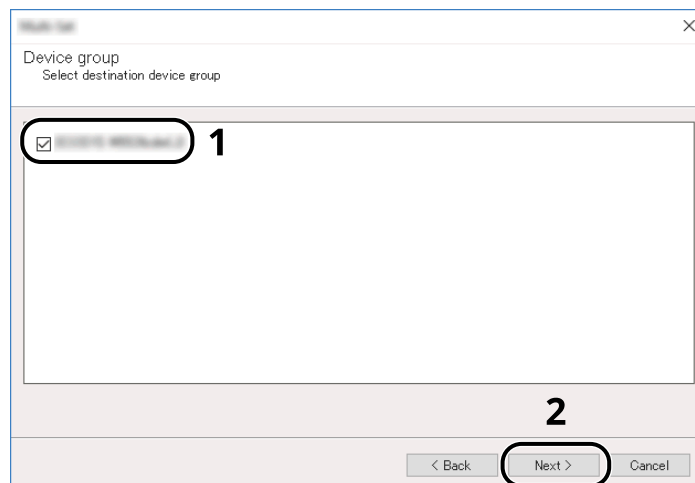

- 4 Select [Device Address Book] and click [Next].

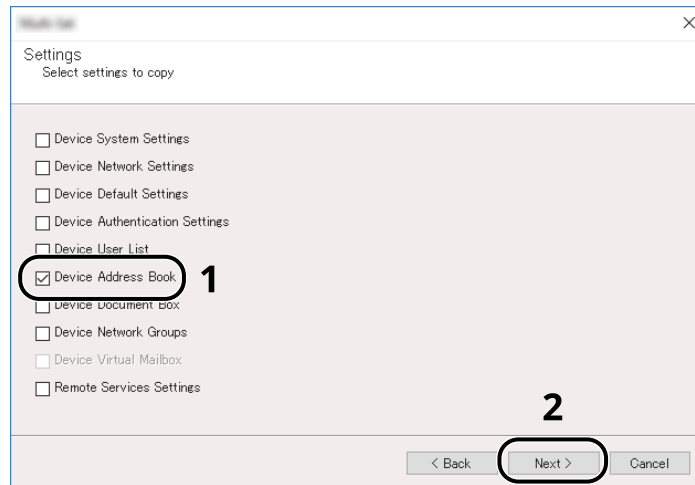

- 5 Select [Create from file] and remove the checkmark from [Overwrite settings on target device], and then click [Next].

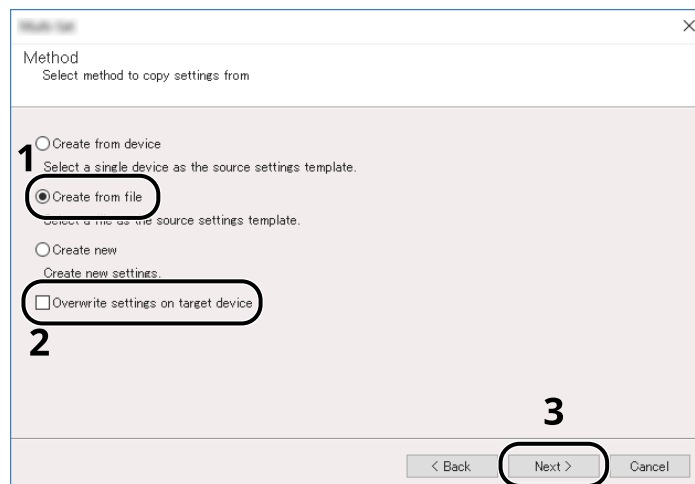

Selecting the [Overwrite settings on target device] checkbox will overwrite the machine's Address Book from entry No.1.

- 6 Click [Browse] and select the backup Address Book file, and then click [Next].



- 7 Click [Finish].

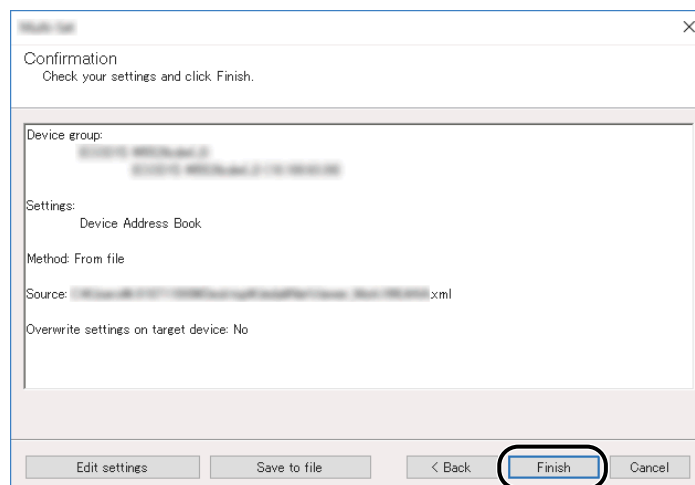

The write process of the Address Book data starts.

- 8 Once the write process is complete, click [Close].

3 Preparation before Use

Load Paper

Loading Paper

Load paper in the cassettes and multipurpose tray.

For the paper load methods for each cassette, refer to the page below.

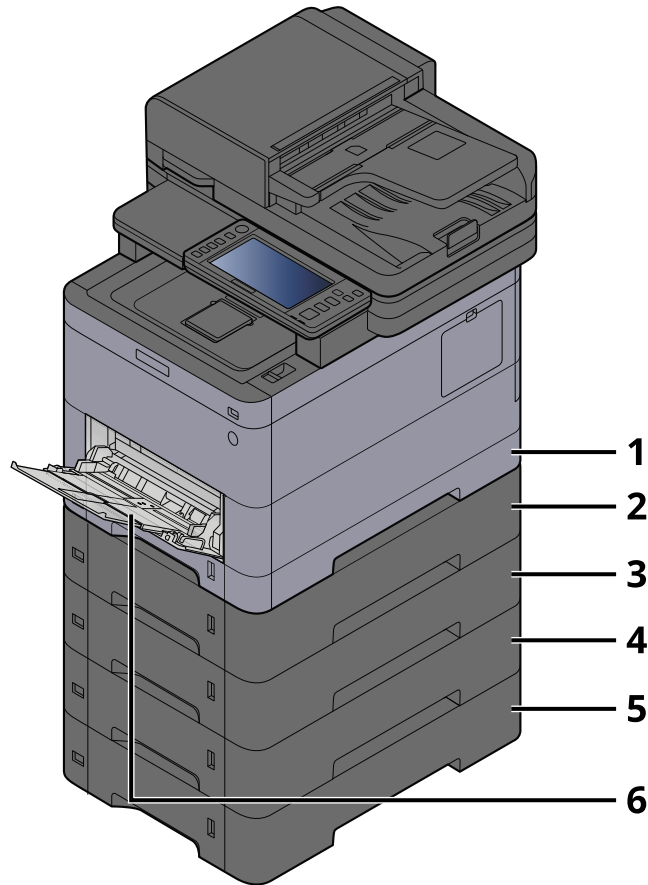

- 1 Cassette 1
➔ [Loading in the Cassettes \(page 146\)](#)
- 2 Cassette 2
➔ [Loading in the Cassettes \(page 146\)](#)
- 3 Cassette 3
➔ [Loading in the Cassettes \(page 146\)](#)
- 4 Cassette 4
➔ [Loading in the Cassettes \(page 146\)](#)
- 5 Cassette 5
➔ [Loading in the Cassettes \(page 146\)](#)
- 6 MultipurposeTray
➔ [Loading Paper in the Multipurpose Tray \(page 150\)](#)

 **NOTE**

- The number of sheets that can be held varies depending on your environment and paper type (thickness).
 - Do not use inkjet printer paper or paper with special coatings. (Doing so may lead to failures such as paper jams.)
 - Use paper made for color printing if you want higher-quality color prints.
-

Precaution for Loading Paper

When you open a new package of paper, fan the sheets to separate them slightly prior to loading in the following steps.

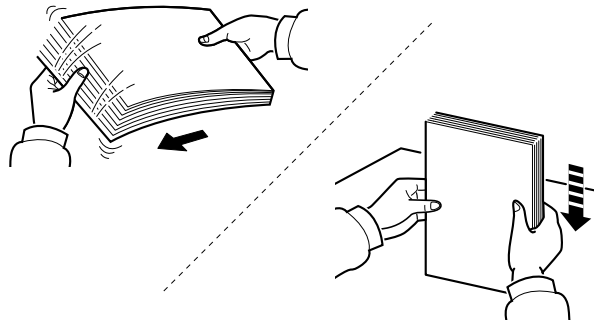

Fan the paper, then tap it on a level surface. In addition, note the following points.

- If the paper is curled or folded, straighten it before loading. Paper that is curled or folded may cause a jam.
- Avoid exposing opened paper to high temperatures and high humidity as dampness can be a cause of problems. Seal any remaining paper after loading in the multipurpose tray or cassettes back in the paper storage bag.
- If the machine will not be used for a prolonged period, protect all paper from humidity by removing it from the cassettes and sealing it in the paper storage bag.

IMPORTANT

If you copy onto used paper (paper already used for printing), do not use paper that is stapled or clipped together. This may damage the machine or cause poor image quality.

NOTE

If you use special paper such as letterhead, paper with holes or paper with pre-prints like logo or company name, refer to the following:

➔ [About Paper \(page 751\)](#)

Paper Specifications available in the Cassettes

The cassettes can hold plain paper, recycled paper or color paper. The number of sheets that can be loaded in each cassette is shown below.

Cassette	Capacity
Cassette 1	TASKalfa MA4500ci: 550 sheets (Plain paper: 75 g/m ²) TASKalfa MA3500ci: 250 sheets (Plain paper: 75 g/m ²)
Cassette 2 to 5	550 sheets (Plain paper: 75 g/m ²)

For details of the supported paper sizes, refer to the following:

→ [Choosing the Appropriate Paper \(page 752\)](#)



NOTE

A5 and A6 paper cannot be loaded in cassettes 2 to 5. (A5-R size can be set)

For the paper type setting, refer to the following:

→ [\[Media Type Setting\] \(page 434\)](#)



IMPORTANT

- Cassettes 1 to 5 can hold 60 to 220 g/m² of paper.
- If you are using a paper weight of 106 g/m² or more, set the media type to Thick and set the weight of the paper you are using.

Loading in the Cassettes

- 1 Pull the cassette completely out of the machine.

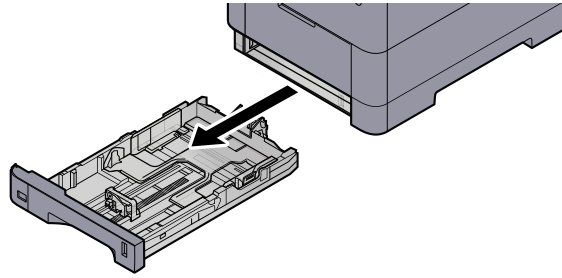

NOTE

When pulling the cassette out of the machine, ensure it is supported and does not fall out.

- 2 Adjust the cassette size.

- 1 Adjust the position of the paper width guides located on the left and right sides of the cassette. Press the paper width adjusting tab and slide the guides to the paper size required.

Paper sizes are marked on the cassette.

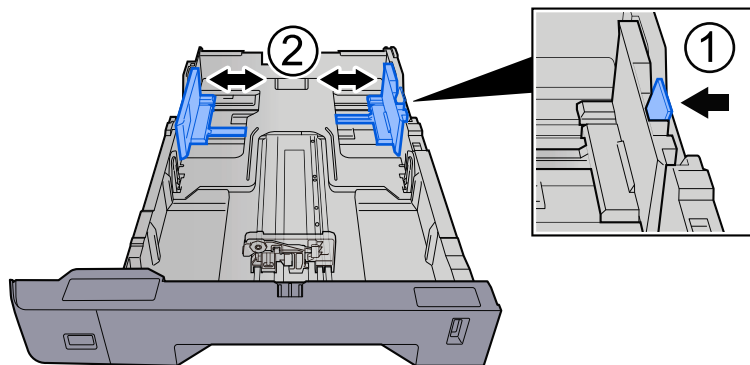

- 2 Adjust the paper length guide to the paper size required. Press the paper length adjusting tab and slide the guides to the paper size required.

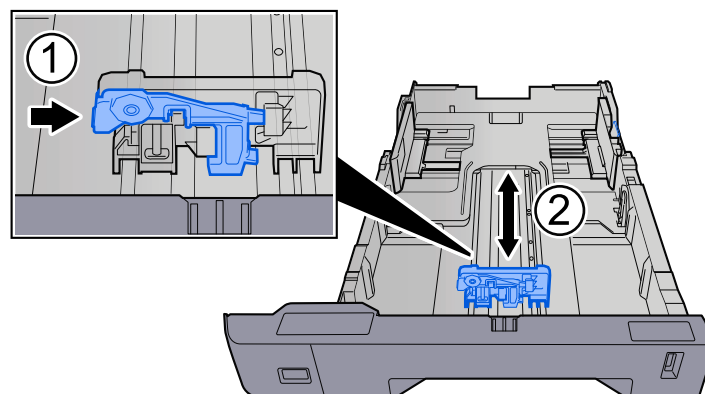

- 3 Turn the size dial so that the size of the paper you are going to use appears in the paper size window.

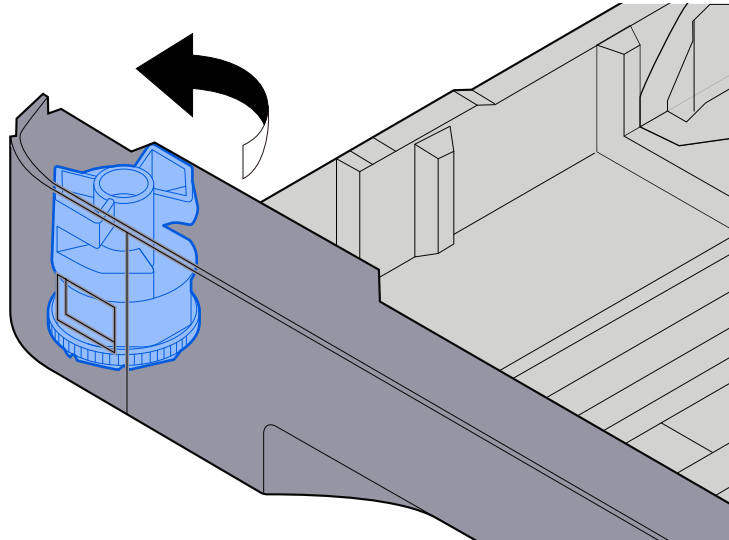

NOTE

Set the size dial to Other if you wish to use paper that is other than the Standard Size. In this case, it is necessary to set the paper size from the operation panel.

➔ [Specifying Paper Size and Media Type \(page 152\)](#)

3 Load paper.

- 1 Fan the paper, then tap it on a level surface to avoid paper jams or skewed printing.
- 2 Load the paper in the cassette.

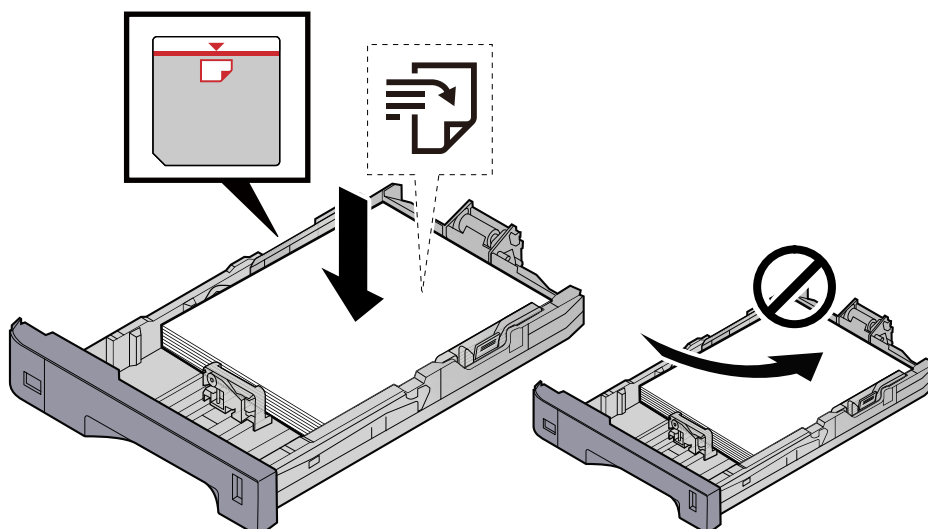

 **IMPORTANT**

- Load the paper with the print side facing up.
 - After removing new paper from its packaging, fan out the paper before loading it in the cassettes.
➔ [Precaution for Loading Paper \(page 144\)](#)
 - Before loading the paper, be sure that it is not curled or folded. Paper that is curled or folded may cause paper jams.
 - Ensure that the loaded paper does not exceed the level indicator (see illustration above).
 - If paper is loaded without adjusting the paper length guide and paper width guide, the paper may skew or become jammed.
-

4 Gently push the cassette back in.

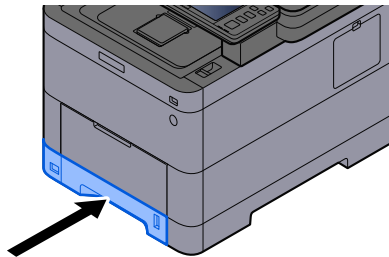

 **NOTE**

There is a paper gauge on the right side of the front of the cassette. The display changes up and down to match the remaining amount of paper.

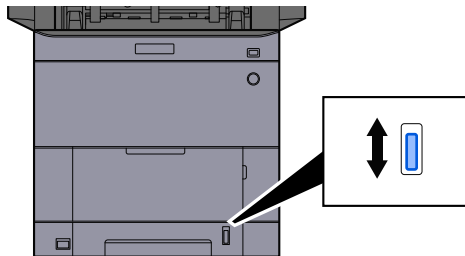

5 Specify the type of paper loaded in the cassette using the operation panel.

➔ [Specifying Paper Size and Media Type \(page 152\)](#)

Paper Specifications available in the Multipurpose Tray

Up to 100 sheets of normal paper (64 g/m²) can be added to the multipurpose tray.

For details of the supported paper sizes, refer to the following:

➔ [Choosing the Appropriate Paper \(page 752\)](#)

For the paper type setting, refer to the following:

➔ [\[Media Type Setting\] \(page 434\)](#)

Be sure to use the multipurpose tray when you print on any special paper.

IMPORTANT

- If you are using a paper weight of 106 g/m² or more, set the media type to Thick and set the weight of the paper you are using.
-

The capacity of the multipurpose tray is as follows.

- Plain paper (64 g/m²), recycled paper, and colored paper: 100 sheets
 - Thick paper (209 g/m²): 15 sheets
 - Thick paper (157 g/m²): 30 sheets
 - Thick paper (104.7 g/m²): 50 sheets
 - Hagaki (Cardstock): 30 sheets
 - Envelope DL, Envelope C5, Envelope #10, Envelope #9, Envelope #6 3/4, Envelope Monarch, Youkei 4, Youkei 2: 5 sheets
 - Coated: 30 sheets
-

NOTE

- When you load custom size paper, enter the paper size by referring to the following:
➔ [\[MP Tray Settings\] \(page 431\)](#)
-

Loading Paper in the Multipurpose Tray

1 Open the multipurpose tray.

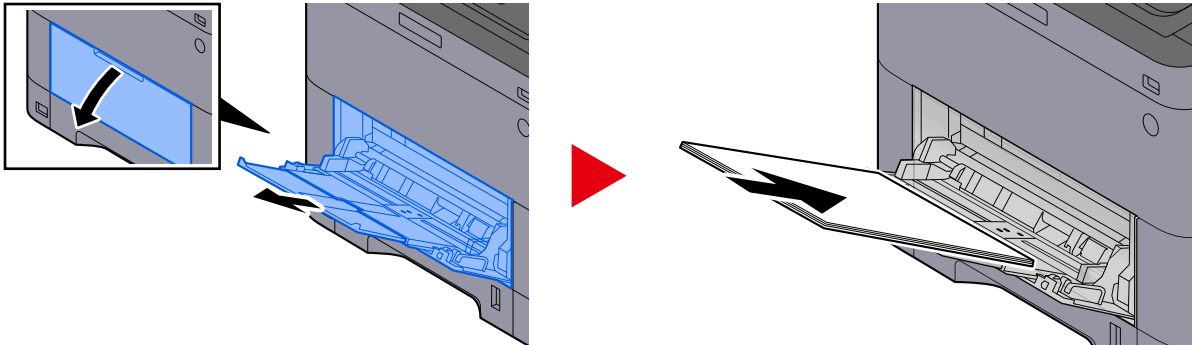

2 Adjust the multipurpose tray size.

Paper sizes are marked on the multipurpose tray.

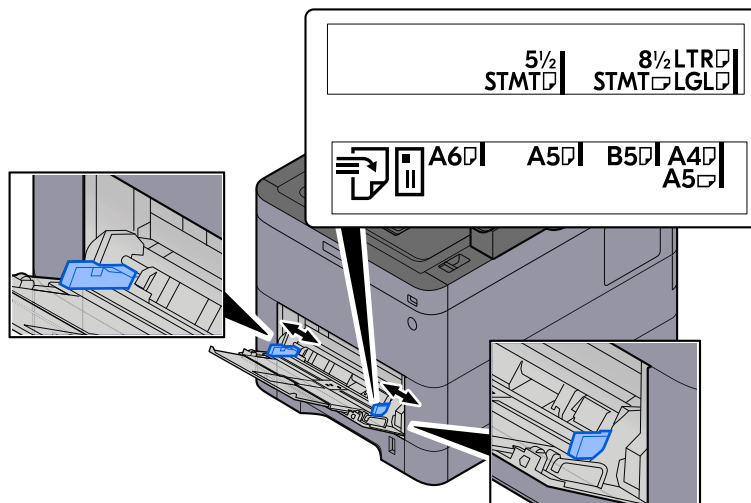

3 Load paper.

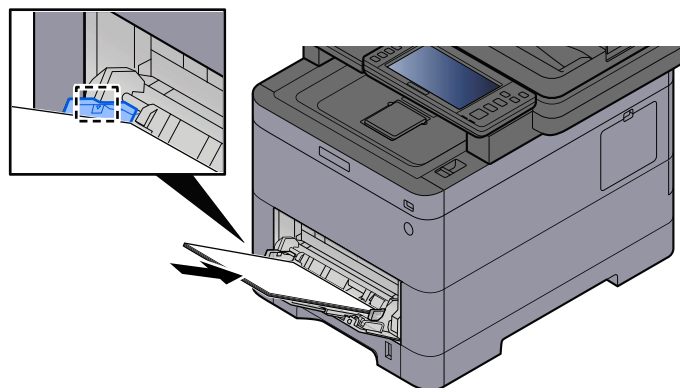

Insert the paper along the paper width guides into the tray until it stops.

After removing new paper from its packaging, fan the paper before loading it in the multipurpose tray.

➔ [Precaution for Loading Paper \(page 144\)](#)

 **IMPORTANT**

- When loading the paper, keep the print side facing up.
 - Curled paper must be uncurled before use.
 - When loading paper into the multipurpose tray, check that there is no paper left over in the tray from a previous job before loading the paper. If there is just a small amount of paper left over in the multipurpose tray and you want to add more, first remove the left-over paper from the tray and include it with the new paper before loading the paper back into the tray.
 - If there is a gap between the paper and the paper width guides, readjust the guides to fit the paper in order to prevent skewed feeding and paper jams.
 - Ensure that the loaded paper does not exceed the load limits.
-

When you load envelopes or cardstock in the multipurpose tray, load the paper with the print side facing up. For the procedure for printing, refer to the Printer Driver User Guide.

➔ **Printer Driver User Guide**

Example: When printing the address.

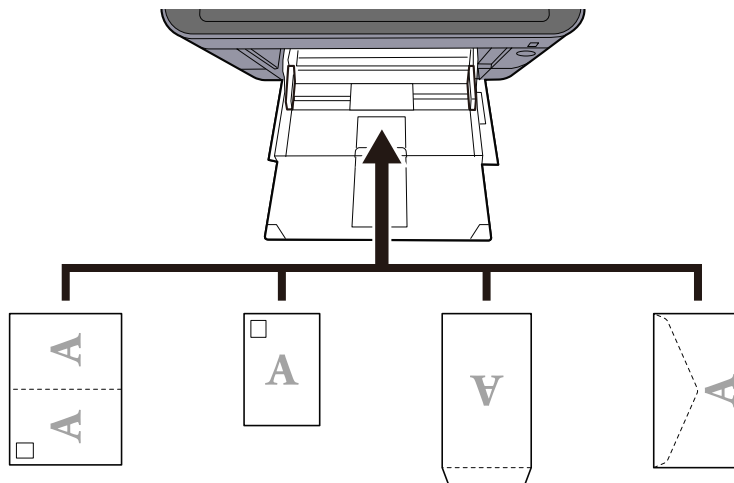

 **IMPORTANT**

- Use unfolded Oufuku hagaki (Return postcard).
 - How to load envelopes (orientation and facing) will differ depending on the type of envelope. Be sure to load it in correctly, otherwise printing may be done in the wrong direction or on the wrong face.
-

 **NOTE**

When you load envelopes in the multipurpose tray, select the envelope type by referring to the following:

➔ [\[MP Tray Settings\] \(page 431\)](#)

4 Specify the type of paper loaded in the multipurpose tray using the operation panel.

→ [Specifying Paper Size and Media Type \(page 152\)](#)

Specifying Paper Size and Media Type

The default paper size setting for cassette 1, for the multipurpose tray and for the optional paper feeder (cassettes 2 to 5) is "A4" or "Letter", and the default media type setting is "Plain". To change the type of paper to be used in cassettes, specify the paper size and media type.

1 Display the screen.

[System Menu / Counter] key > [DeviceSettings] > [Paper Feeding] > Select cassette

2 Select the paper size and paper type.

Cassette Paper Size and Media Type

Set the size of paper and Media type used in cassettes.

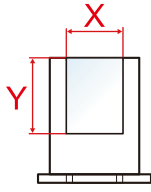
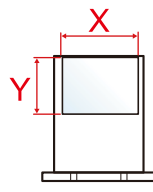
Item	Description
[Paper Size]	<p>Select the paper size. Set only when the size dial of the cassette is aligned with "Other".</p> <p>Value (Cassette 1) [A4], [A5-R], [A5], [A6], [B5], [B6], [Folio], [216 x 340 mm], [Letter], [Legal], [Statement-R], [Statement], [Executive], [OficioII], [16K], [ISO B5], [Custom]</p> <p>Value (Cassettes 2 to 5) [A4], [A5-R], [B5], [B6], [Folio], [216 x 340 mm], [Letter], [Legal], [Statement-R], [Executive], [OficioII], [16K], [ISO B5], [Envelope #10], [Envelope #9], [Envelope #6], [Envelope Monarch], [Envelope DL], [Envelope C5], [Youkei 2], [Youkei 4], [Nagagata 3], [Nagagata 4], [Younaga 3], [Custom]</p> <p>For custom paper size, set the size for each cassette. → [Custom Paper Settings] (page 432)</p> <div style="display: flex; justify-content: space-around; align-items: center;"> <div style="text-align: center;"> <p>Vertical</p>  </div> <div style="text-align: center;"> <p>Horizontal</p>  </div> </div>

Item	Description
[Media Type]	<p>Value (Cassette 1) [Plain], [Transparency], [Rough],[Vellum], [Recycled], [Preprinted], [Bond], [Color], [Prepunched], [Letterhead], [Thick], [High Quality], [Custom 1] to [Custom 8]</p> <p>Value (Cassettes 2 to 5) [Plain], [Rough],[Vellum], [Labels], [Recycled], [Preprinted], [Bond], [Color], [Prepunched], [Letterhead], [Envelope], [Thick], [Coated], [High Quality], [Custom 1] to [Custom 8]</p> <ul style="list-style-type: none"> To change to a media type other than "Plain," refer to the following" <ul style="list-style-type: none"> ➔ [Media Type Setting] (page 434) When a paper weight that cannot be loaded in the cassette is set for a media type, that media type does not appear. To print on preprinted or prepunched paper or on letterhead, refer to the following: <ul style="list-style-type: none"> ➔ [Paper Feed Settings] (page 436)

Multipurpose Tray Paper Size and Media Type

Set the size of paper and media type used in the multipurpose tray.

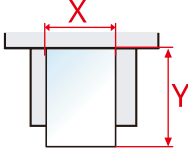
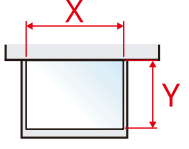
Item	Description
[Paper Size]	<p>Select the paper size. Value: [A4], [A5], [A5-R], [A6], [B5], [B6], [Folio], [216 x 340 mm], [Letter], [Legal], [Statement], [Statement-R], [Executive], [OficioII], [16K], [ISO B5], [Envelope #10], [Envelope #9], [Envelope #6], [Envelope Monarch], [Envelope DL], [Envelope C5], [Hagaki], [Oufukuhagaki], [Youkei 4], [Youkei 2], [Younaga 3], [Nagagata 3], [Nagagata 4], [Custom]</p> <p>For custom paper size, set the size for each cassette. ➔ [Custom Paper Settings] (page 432)</p> <div style="display: flex; justify-content: space-around; align-items: center;"> <div style="text-align: center;"> <p>Vertical</p>  </div> <div style="text-align: center;"> <p>Horizontal</p>  </div> </div>
[Media Type]	<p>Select the media type. Value: [Plain], [Rough],[Vellum], [Labels], [Recycled], [Preprinted], [Bond], [Hagaki], [Color], [Prepunched], [Letterhead], [Envelope], [Thick], [Coated], [High Quality], [Custom 1] to [Custom 8]</p> <p>To change to a media type other than "Plain," refer to the following. ➔ [Media Type Setting] (page 434)</p> <p>To print on preprinted or prepunched paper or on letterhead, refer to the following: ➔ [Paper Feed Settings] (page 436)</p>

 **NOTE**

The available media types for printing received faxes are as shown below.

[Plain], [Labels], [Bond], [Recycled], [Vellum], [Color], [Envelope], [Hagaki], [Coated], [Thick], [High Quality], [Custom 1] to [Custom 8]

The fax function can be used on products equipped with fax capability.

Paper Stopper

When using paper A4/Letter or larger, open the paper stopper shown in the figure.

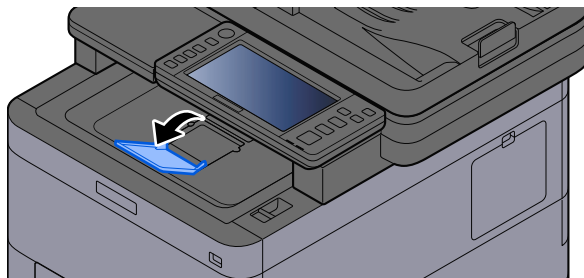

Preparation for Sending a Document to a Shared Folder in a PC

Check the information that needs to be set on the machine and create a folder to receive the document on your computer. Screens of Windows 10 are used in the following explanation. The details of the screens will vary in other versions of Windows.



Log on to Windows with administrator privileges.

Making a Note of the Computer Name and Full Computer Name

Check the name of the computer name and full computer name.

1 Display the screen.

Select the Windows [Start] button → [Windows System Tool] → [Control Panel] → [System and Security] → [System].



- For Windows 11, select the Windows [Start] button → [All apps] → [Settings] → [System] → [About] → [Advanced system settings].
- In Windows 8.1, right-click [PC] in the Start screen and select [Properties]. Or, right-click the Window icon and select [System].

2 Check the computer name.

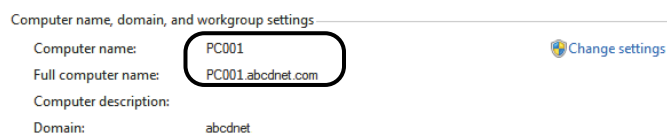

Check the computer name and full computer name.

Screen example:

Computer name: PC001

Full computer name: PC001.abcdnet.com

After checking the computer name, click the [Close] button to close the "System" screen.

Making a Note of the User Name and Domain Name

Check the domain name and user name for logging onto Windows.

1 Display the screen.

Click the [Start] button on the Windows and then select → [Windows System and]→ [Command Prompt].



NOTE

- For Windows 11, select the [Start] button → [All apps]→ [Windows Tools]→ [Command Prompts].
- In Windows 8.1, click [Search] in the Charms Bar on Desktop, and enter "Command Prompt" in the search box. Select [Command Prompt] in the search list.

The Command Prompt window appears.

2 Check the domain name and user name.

At the Command Prompt, enter "net config workstation" and then press [Enter].

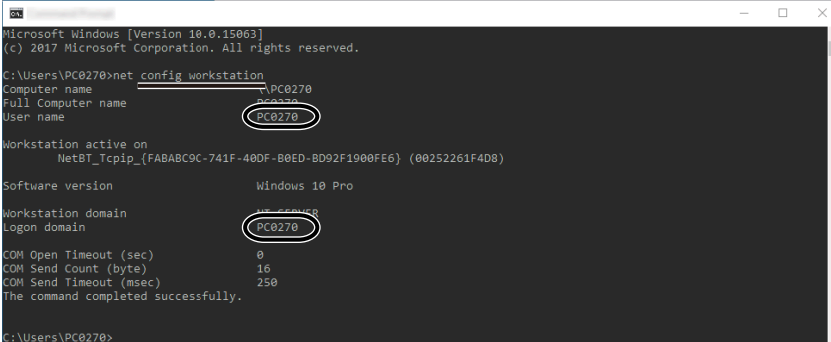

```
Microsoft Windows [Version 10.0.15063]
(c) 2017 Microsoft Corporation. All rights reserved.

C:\Users\PC0270>net config workstation
Computer name                PC0270
Full Computer name          PC0270
User name                    PC0270

Workstation active on
NetBT_Tcpip_{FABABC9C-741F-40DF-B0E0-BD92F1900FE6} (00252261F4D8)

Software version             Windows 10 Pro

Workstation domain          PC0270
Logon domain                 PC0270

COM Open Timeout (sec)      0
COM Send Count (byte)      16
COM Send Timeout (msec)    250
The command completed successfully.

C:\Users\PC0270>
```

Check the user name and domain name.

Screen example:

User Name: PC0270

Domain Name: PC0270

Creating a Shared Folder, Making a Note of a Shared Folder

Create a shared folder to receive the document in the destination computer.

NOTE

If there is a workgroup in System Properties, configure the settings below to limit folder access to a specific user or group.

- 1 In Windows 10, open up a window in File Explorer and select [View], → [Options], and then → [Folder Options].
In Windows 11, open up a window in File Explorer and select [...], →, and then [Options].
In Windows 8.1, select [Settings] in charms on Desktop, and select [Control Panel]→ [Appearance and Personalization], and then → [Folder Options].

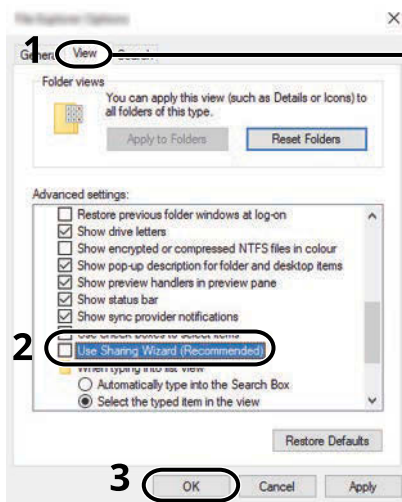

Make sure that the [View] tab is selected.

- 2 Remove the checkmark from [Use Sharing Wizard (Recommended)] in "Advanced settings".
- 3 Click [OK].

1 Create a folder.

Create a folder on your computer. For example, create a folder with the name "scannerdata" on the desktop.

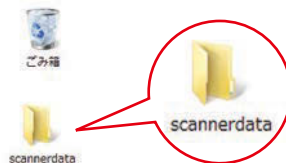

2 Configure permission settings.

- 1 Right-click the "scannerdata" folder, select [Property]→, and click [Sharing] tab, and → [Advanced Sharing].

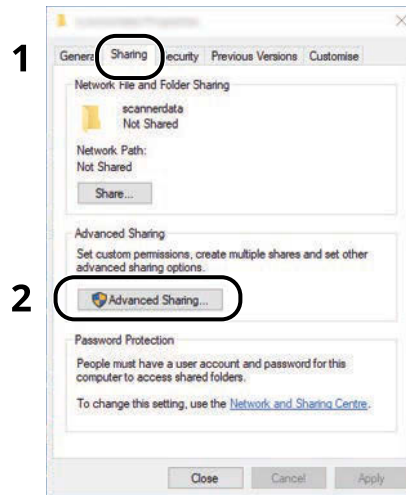

- 2 Select the [Share this folder] checkbox and click the [Permissions] button.

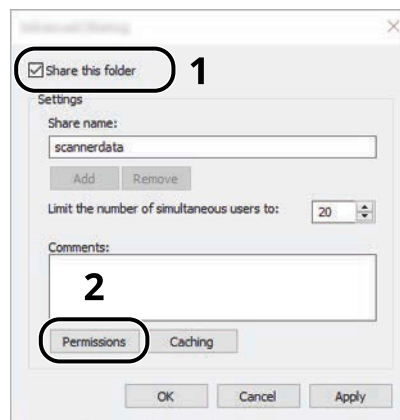

- 3 Make a note of the Share name.

- 4 Click the [Add] button.

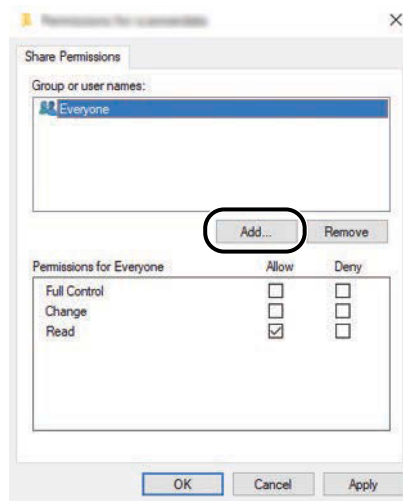

- 5 Specify the location.

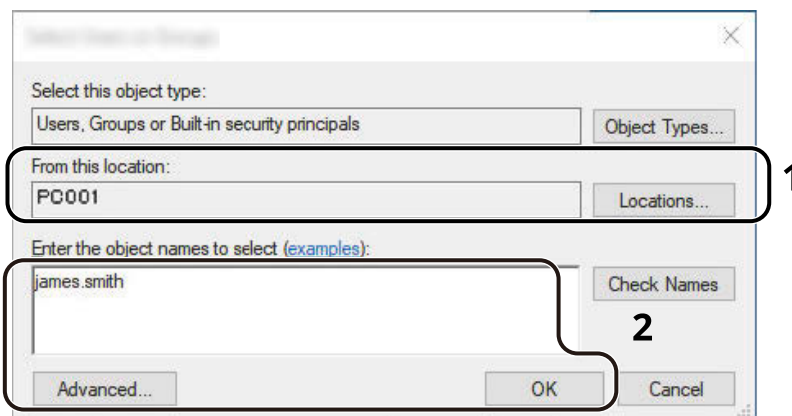

- 1 If the computer name that you made a note is the same as the domain name:
 If the computer name is not shown in the "From this location" , click the [Locations] button, select the computer name, and click the [OK] button.
 Example: PC001
 If the computer name that you made a note is not the same as the domain name:
 If the text after the first dot (.) in the full computer name that you made a note of does not appear in the "From this location" , click the [Locations] button, select the text after the dot (.), and click the [OK] button.
 Example: abcdnet.com
 ➔ [Making a Note of the Computer Name and Full Computer Name \(page 156\)](#)
- 2 Enter the user name that you made a note of on page in the text box, and click the [OK] button.
 Also the user name can be made by clicking the [Advanced] button and selecting a user.

- 6 Set the access permission for the user selected.

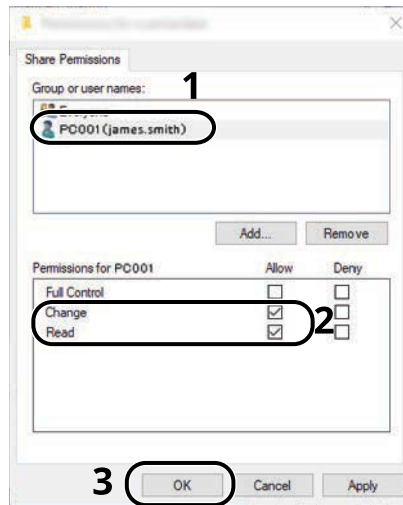

- 1 Select the user you entered.
- 2 Select the [Allow] checkbox of "Change" and "Read"
- 3 Click the [OK] button.

 **NOTE**

"Everyone" gives sharing permission to everyone on the network. To strengthen security, it is recommended that you select "Everyone" and remove the [Allow] checkmark of "Read".

- 7 Click the [OK] button in the "Advanced Sharing" screen to close the screen.
- 8 Check the details set in the [Security] tab.

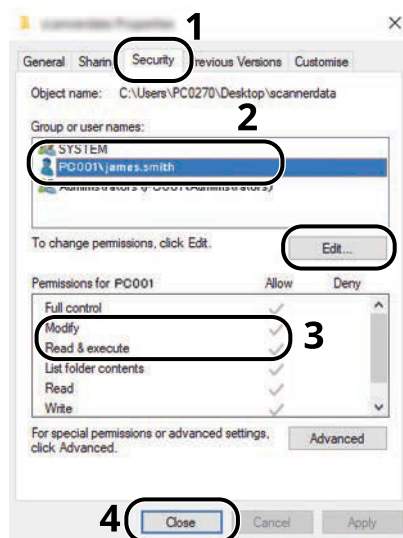

1 Select the [Security] tab.

2 Select the user you entered.

If the user does not appear on "Group or user names", click [Edit] button to add user in a similar way of "configuration of permission settings".

3 Make sure that checkmarks appear on [Allow] checkbox for the "Modify" and "Read & execute".

4 Click the [Close] button.

Configuring Windows Firewall

Permit sharing of files and printers and set the port used for SMB transmission.

NOTE

Log on to Windows with administrator privileges.

1 Check file and printer sharing.

- 1 Select the Windows [Start] button → [Windows System]→ [Control Panel]→ [System and Security]→ [Allow an app through Windows Firewall].



NOTE

- For Windows 11, select the Windows [Start] button → [All apps]→ [Windows Tools]→ [Control Panel]→ [System and Security]→ [Allow an app through Windows Firewall].
- For Windows 8.1, in the Charms Bar on Desktop, click [Settings]→ [Control Panel]→ [System and Security]→ [Windows Firewall].
- If the User Account Control dialog box appears, click the [Continue] button.

- 2 Select the [File and Printer Sharing] checkbox.

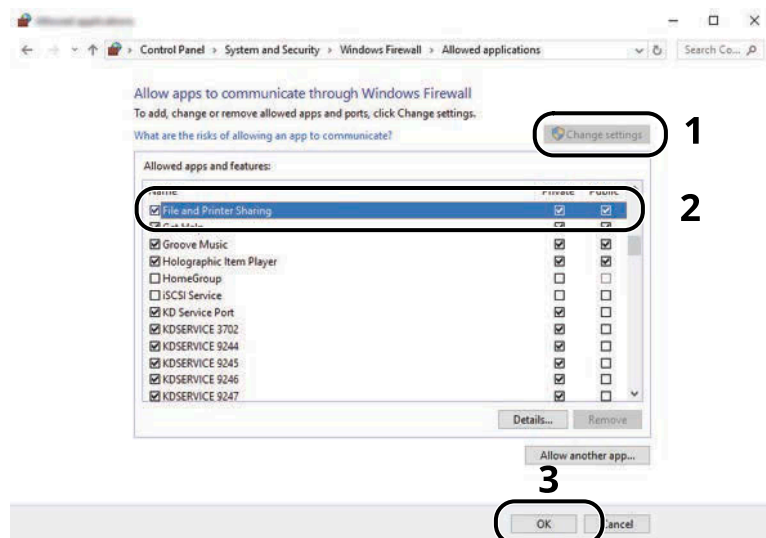

2 Add a port.

- 1 Select the Windows [Start] button → [Windows System]→ [Control Panel]→ [System and Security]→ [Check firewall status].



- 2 Select [Advanced settings].

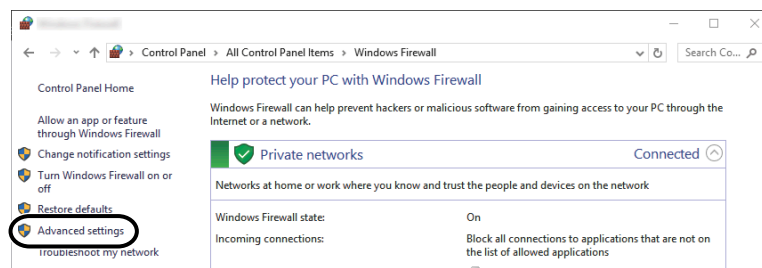

- 3 Select [Inbound Rules].

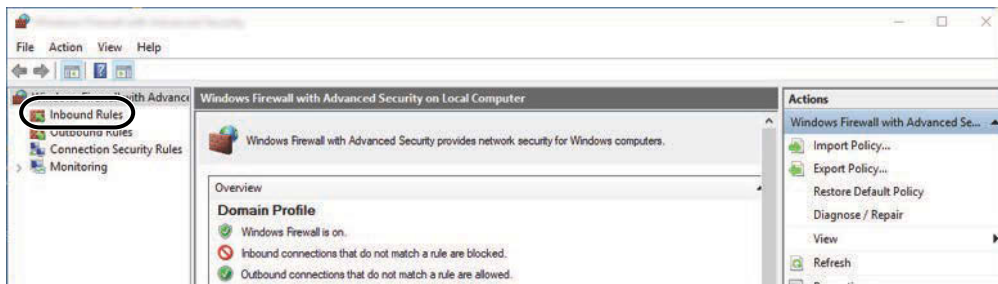

- 4 Select [New Rules].

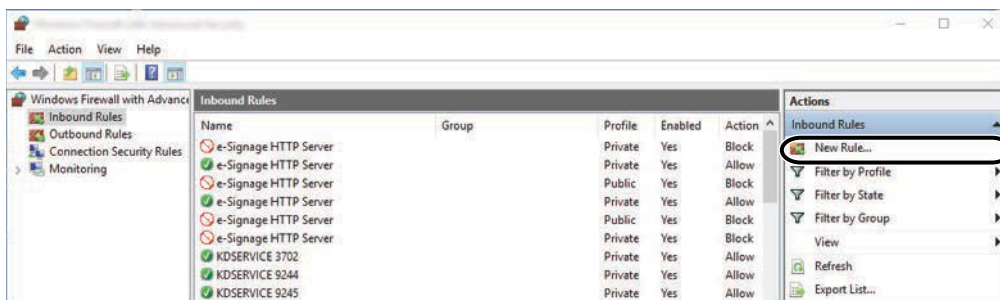

5 Select [Port].

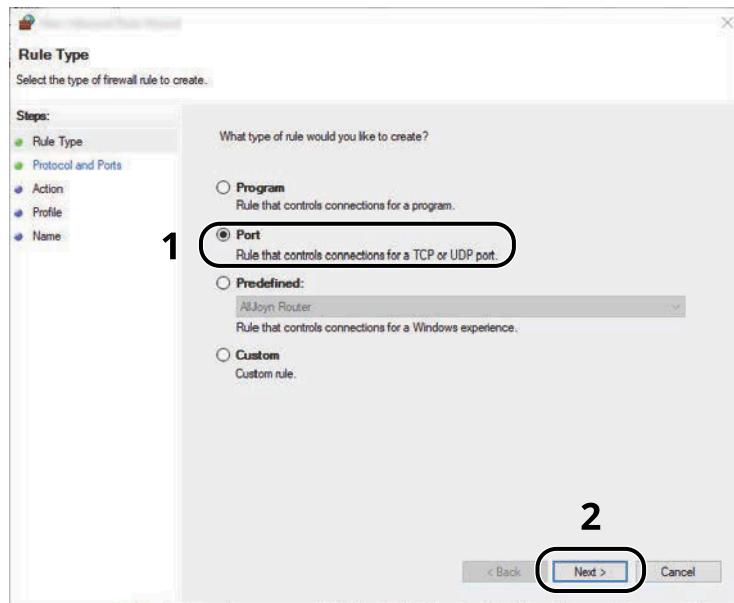

6 Select [TCP] as the port to apply the rule to. Then select [Specific local ports] and enter "445" then click [Next].

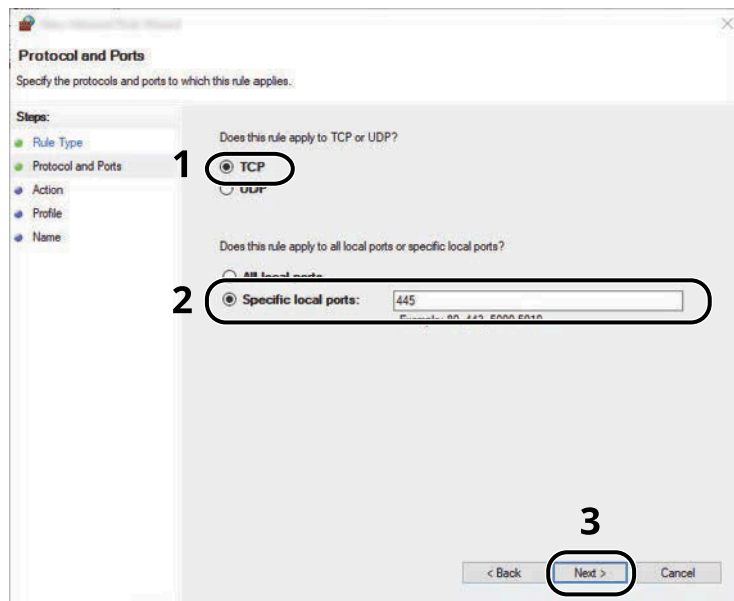

7 Select [Allow the connection] and click the [Next] button.

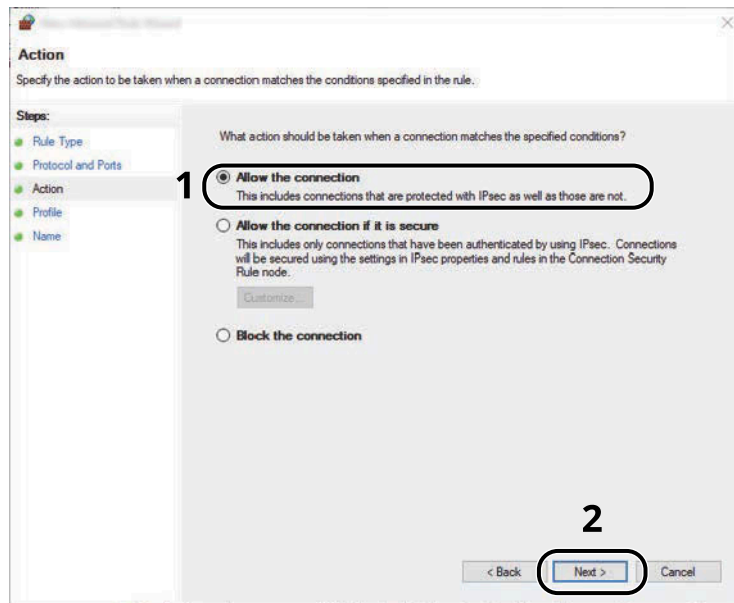

8 Make sure all checkboxes are selected and click the [Next] button.

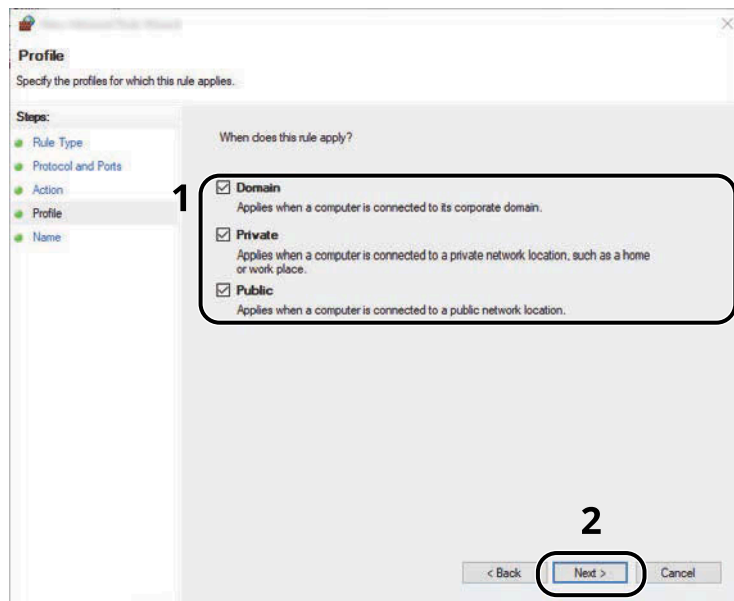

- 9 Enter "Scan to SMB" in "Name" and click [Finish].

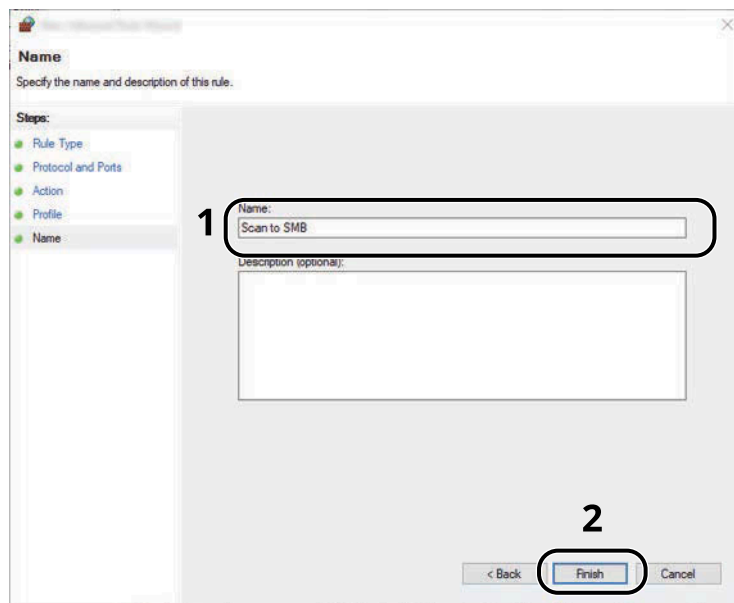

Scan to Folder Setup Tool for SMB

An environment for sending a document to Windows can be set up smoothly by using the Scan to Folder Setup Tool for SMB downloaded from Download Center (<https://kyocera.info/>).

By operating the Scan to Folder Setup Tool for SMB, you can configure the following settings.

- Create a shared folder in a PC for receiving documents:
A new folder can be easily created on the desktop. Also, the newly created folder is automatically set as a shared folder.
- Set the created shared folder as an address on this machine:
Information about such things as the name of the computer and shared names for the shared folder is easily recorded in the address book of this machine with a sequence of actions. Can also be registered on the One Touch Keys.

NOTE

- Log on to Windows with administrator privileges.
- If user login administration is enabled, log in with administrator privileges or as a user with execution authority.

1 Download a software from the website.

- 1 Launch your Web browser.
- 2 Enter "<https://kyocera.info/>" to the browser's address bar or location bar.

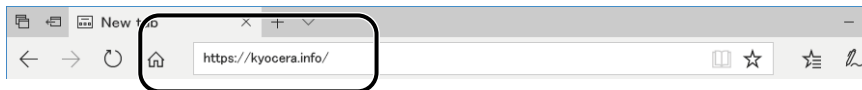

- 3 Enter and search the product name, and select this product from the candidate list.

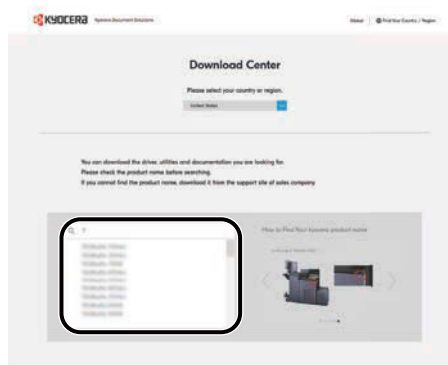

- 4 Change the selected operating system and its language setting as needed.

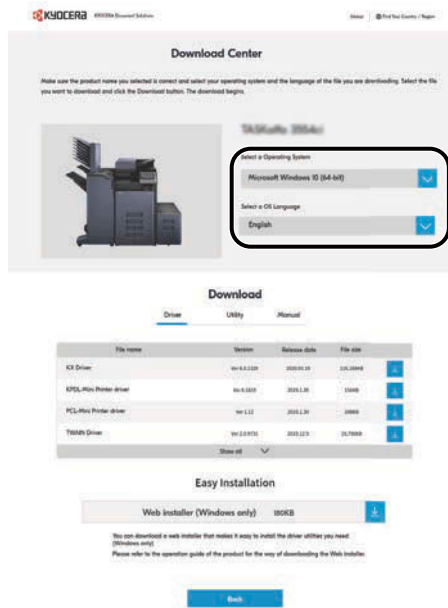

- 5 "Utility" tab >  of "Scan to Folder Setup Tool for SMB"
The Scan to Folder Setup Tool for SMB will be downloaded.

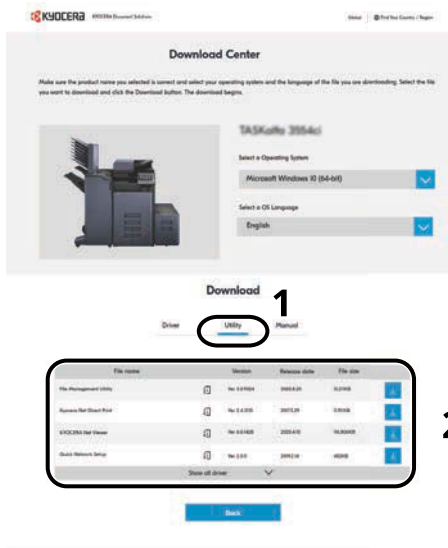

- 6 Double-click the downloaded installer to launch.

2 Configure the settings.

- 1 Select the device to use and click [Next].

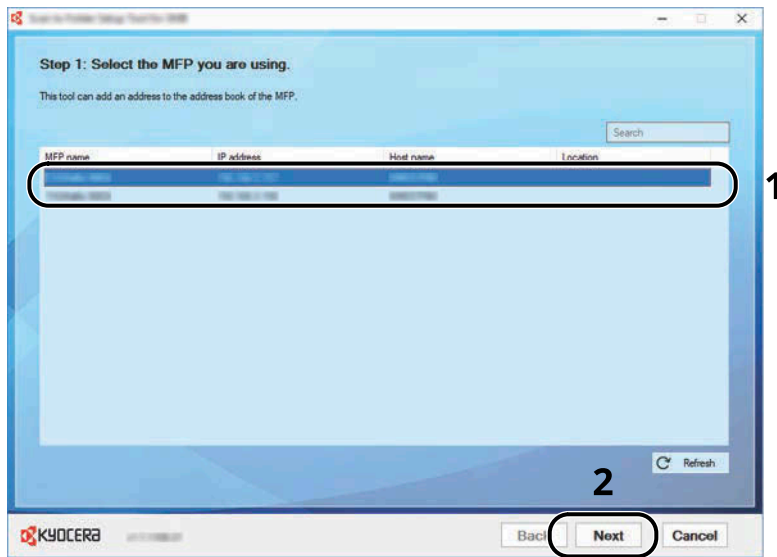

NOTE

- The machine cannot be detected unless it is on. If the computer fails to detect the machine, verify that it is connected to the computer via a network cable and that it is turned on and click  [Refresh].
- If user administration is valid on this machine, the user authentication screen appears. Log in with administrator privileges or as a user with execution authority.

The address book of the device appears.

- 2 Select [Add].

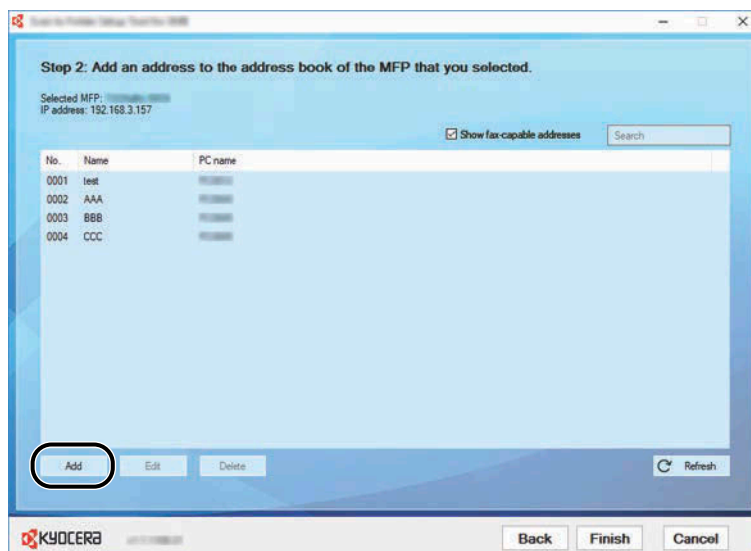

 **NOTE**

- Clicking on [Edit] after selecting the registered address allows you to change the content of the registration.
- Unchecking the [Show fax-capable addresses] check-box will hide the address containing the fax.

3 Create a new folder.

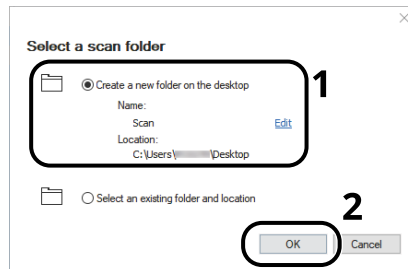

Select "Create a new folder on the desktop" and click [OK] to create a new folder on the desktop. (The default folder name is "Scan".)

 **NOTE**

- Click [Edit] to change the desktop folder name.
- Selecting [Select an existing folder and address] allows you to select an existing folder that is already set as a shared folder on the PC.

4 Enter the information requested to register the address.

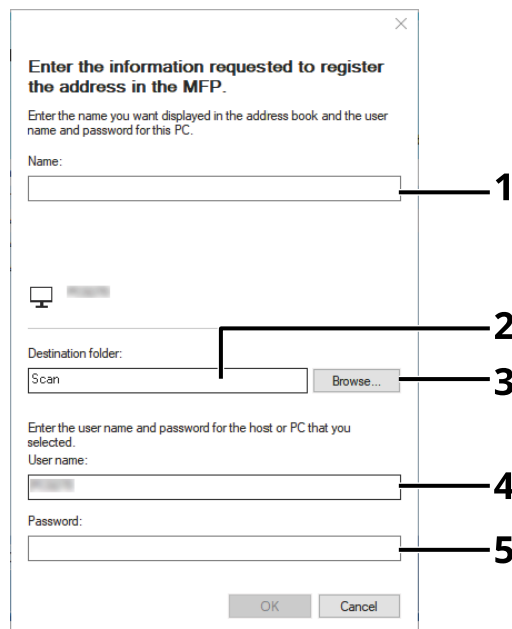

- 1 Enter the name for display in the address book.
- 2 Display the folder name and path to the shared folder.
- 3 Shared folders can be selected from a PC on the network.
- 4 Display the user name of the selected PC.

- 5 Enter the password corresponds to the log in user name of the selected PC.
- 5 Click [OK] to register the address to the address book.
- 6 Click [Close].
- 7 To register the registered address in a One Touch key, click [Yes].

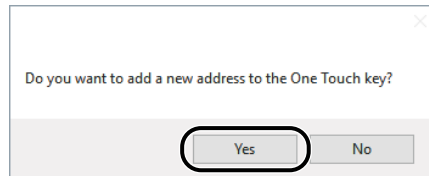

- 8 Select a One Touch Key with no registered destination, and click [Submit].



- 9 Click [Close].
- 10 Click [Finish] to exit the Scan to Folder Setup Tool for SMB.

Registering Destinations in the Address Book

Save frequently used destinations to the Address Book or One Touch Keys. The saved destinations can be changed. The destinations are available for Send as E-mail, Send to Folder, and Fax Transmission (Only on products with the fax function installed).

NOTE

- Registering and editing of the Address Book can also be done in Command Center RX.
 - ➔ [Registering Destinations \(page 129\)](#)
 - Editing of the Address Book and One Touch Keys can be restricted to administrators.
 - ➔ [Edit Restriction \(page 463\)](#)
-

Adding a Destination (Address Book)

Add a new destination to the Address Book. There are two registering methods, contacts and groups. When adding a group, enter the group name and select group members from the Address Book.

NOTE

If registering and editing of the Address Book is restricted to administrators, you can edit the Address Book by logging in with administrator privileges.

- ➔ [Edit Restriction \(page 463\)](#)
 - ➔ **Command Center RX User Guide**
-

Registering an Address (E-mail Address)

The registering method of an E-mail address to Address Book is as follows.

1 Display the screen.

[System Menu / Counter] key > [FunctionSettings] > [Address Book] > [Add/Edit Machine Address Book] > [Add] > [Contact]

2 Add the name.

- 1 Enter the destination name to be displayed on the Address Book.
-

NOTE

For details on entering characters, refer to the following:

- ➔ [Character Entry Method \(page 748\)](#)
-

- 2 Enter an address number.

To have the number assigned automatically, select [Auto] (0000).



NOTE

- Address Number is an ID for a destination. You can select any available number out of 200 numbers for contacts and 50 numbers for groups.
 - If you specify an address number that is already in use, an error message appears when you select [Save] and the number cannot be registered. If you set [Auto] (0000) as the address number, the address is registered under the lowest available number.
-

3 Add the address.

- 1 Select .
 - 2 Select the entry field, and enter the E-mail address.
-



NOTE

For details on entering characters, refer to the following:

➔ [Character Entry Method \(page 748\)](#)

4 Check if the destination entry is correct > [Save]

The destination is added to the Address Book.

To add a new address to the One Touch Key, select [Save] and follow the on-screen instructions to enter the necessary information.



NOTE

Refer to the following for registering the One Touch Key.

➔ [Adding a Destination on One Touch Key \(page 185\)](#)

Registering an Address (Folder (SMB) Address)

The registering method of an folder (SMB) address to Address Book is as follows.

1 Display the screen.

[System Menu / Counter] key > [FunctionSettings] > [Address Book] > [Add/Edit Machine Address Book] > [Add] > [Contact]

2 Add the name.

- 1 Enter the destination name to be displayed on the Address Book.



NOTE

For details on entering characters, refer to the following:

➔ [Character Entry Method \(page 748\)](#)

- 2 Enter an address number.

To have the number assigned automatically, select [Auto] (0000).



NOTE

- Address Number is an ID for a destination. You can select any available number out of 200 numbers for contacts and 50 numbers for groups.
 - If you specify an address number that is already in use, an error message appears when you select [Save] and the number cannot be registered. If you set [Auto] (0000) as the address number, the address is registered under the lowest available number.
-

3 Add the address.

- 1 Select .

- 2 To directly specify the SMB folder, enter "Host Name", "Port", "Folder Path", "Login User Name" and "Login Password".



NOTE

For the computer name, share name, domain name, and user name, enter the information that you noted when you created the shared folder. For details on creating shared folders, refer to the following:

➔ [Preparation for Sending a Document to a Shared Folder in a PC \(page 156\)](#)

You can search for a folder on a PC on the network. Select [Search Folder from Network] or [Search Folder by Host Name]. Select the folder from the Search Results list.



NOTE

- If you selected [Search Folder from Network], you can search all PCs on the network for a destination.
 - If you selected [Search Folder by Host Name], you can enter the "Domain/Workgroup", and "Host Name" to search PCs on the network for the destination.
 - A maximum of 500 addresses can be displayed. Select the host name (PC name) that you want to specify in the screen that appears, and select [OK]. The login user name and login password entry screen appears.
 - After you enter the login user name and login password name of the destination PC, the shared folders appear. Select the folder that you want to specify and select [OK]. The address of the selected shared folder is set.
-

The table below explains the items to be entered.

"Host Name"

Computer name.

Specify "Host name" or "IP address". To enter the IPv6 address, enclose the address in brackets [].
(Example: [2001:db8:a0b:12f0::10])

"Port"

Port number

If the port number is not specified, the default port number is 445.

"Folder Path"

Share name.

For example: scannerdata

If saving in a folder in the shared folder:

share name\folder name in shared folder

"Login User Name"

- If the computer name and domain name are the same

User Name

For example: james.smith.

- If the computer name and domain name are different

Domain name\User name

For example: abcdnet\james.smith

User name@Domain name

(Example: james.smith@abcdnet)

"Login Password"

Windows logon password

(Case sensitive)



NOTE

- For details on entering characters, refer to the following:
 - ➔ [Character Entry Method \(page 748\)](#)
 - Select [Connection Test] to check the connection to the server you chose. If the connection fails, check the entries you made.
-

4 Check if the destination entry is correct > [Save]

The destination is added to the Address Book.

To add a new address to the One Touch Key, select [Save] and follow the on-screen instructions to enter the necessary information.



NOTE

Refer to the following for registering the One Touch Key.

- ➔ [Adding a Destination on One Touch Key \(page 185\)](#)
-

Registering an Address (Folder (FTP) Address)

The registering method of an folder (FTP) address to Address Book is as follows.

1 Display the screen.

[System Menu / Counter] key > [FunctionSettings] > [Address Book] > [Add/Edit Machine Address Book] > [Add] > [Contact]

2 Add the name.

- 1 Enter the destination name to be displayed on the Address Book.



NOTE

For details on entering characters, refer to the following:

➔ [Character Entry Method \(page 748\)](#)

- 2 Enter an address number.

To have the number assigned automatically, select [Auto] (0000).



NOTE

- Address Number is an ID for a destination. You can select any available number out of 200 numbers for contacts and 50 numbers for groups.
 - If you specify an address number that is already in use, an error message appears when you select [Save] and the number cannot be registered. If you set [Auto] (0000) as the address number, the address is registered under the lowest available number.
-

3 Add the address.

- 1 Select .

- 2 Enter "Host Name", "Port", "Folder Path", "Login User Name" and "Login Password".

The table below explains the items to be entered.

"Host Name"

Host name or IP address of FTP server

To enter the IPv6 address, enclose the address in brackets [].

(Example: [2001:db8:a0b:12f0::10])

"Port"

Port number

If the port number is not specified, the default port number is 21.

"Folder Path"

Path for the file to be stored.

For example: User\ScanData

If no path is entered, the file is stored in the home directory.

When the FTP server is based on Linux/UNIX, the path including the sub-folder is combined by the slash "/" not using the back-slash.

"Login User Name"

FTP server login user name

"Login Password"

FTP server login password



NOTE

- For details on entering characters, refer to the following:
 - ➔ [Character Entry Method \(page 748\)](#)
 - Select [Connection Test] or [Connection Test (Encrypted TX)] to check the connection to the server you chose. If the connection fails, check the entries you made.
-

4 Check if the destination entry is correct > [Save]

The destination is added to the Address Book.

To add a new address to the One Touch Key, select [Save] and follow the on-screen instructions to enter the necessary information.



NOTE

Refer to the following for registering the One Touch Key.

- ➔ [Adding a Destination on One Touch Key \(page 185\)](#)
-

Add the group

Compile two or more contacts into a group. Designations in the group can be added at the same time. When adding a group, a maximum of 50 groups can be added in the Address Book.

NOTE

To add a group, you need individually added destinations. Register one or more individual destinations as needed before proceeding. Up to 100 destinations for the E-mail, FAX, and a total of 5 destinations for the FTP and SMB can be registered per group.

1 Display the screen.

[System Menu / Counter] key > [FunctionSettings] > [Address Book] > [Add/Edit Machine Address Book] > [Add] > [Group]

2 Add the name.

- 1 Enter an address number.

To have the number assigned automatically, select [Auto] (0000).

NOTE

- Address Number is an ID for a destination. You can select any available number out of 200 numbers for contacts and 50 numbers for groups.
 - If you specify an address number that is already in use, an error message appears when you select [Save] and the number cannot be registered. If you set [Auto] (0000) as the address number, the address is registered under the lowest available number.
-

- 2 Enter the group name displayed on the Address Book.
-

NOTE

For details on entering characters, refer to the following:

➔ [Character Entry Method \(page 748\)](#)

3 Select the destinations.

- 1 Select destinations (contacts) to add to the group.

Put a checkmark in the checkbox to select an item and remove the checkmark to cancel the selection.

NOTE

Destinations can be sorted or searched by destination name or address number.

➔ [Choosing from the Address Book \(page 270\)](#)

4 Check if the group entry is correct > [Save]

The group is added to the Address Book.

To add a new address to the One Touch Key, select [Save] and follow the on-screen instructions to enter the necessary information.



NOTE

Refer to the following for registering the One Touch Key.

➔ [Adding a Destination on One Touch Key \(page 185\)](#)

Editing Contact Address in Address Book

Edit the destinations (contacts) you added to the Address Book.

1 Display the screen.

- 1 [System Menu / Counter] key > [FunctionSettings] > [Address Book] > [Add/Edit Machine Address Book]
- 2 Select  (information icon) for the destination or group to edit.



NOTE

Destinations and group can be sorted or searched by destination name or address number.

➔ [Choosing from the Address Book \(page 270\)](#)

2 Edit a contact address.

- 1 Change "Name", "Address Number" and destination type and address.
 - ➔ [Registering an Address \(E-mail Address\) \(page 173\)](#)
 - ➔ [Registering an Address \(Folder \(SMB\) Address\) \(page 175\)](#)
 - ➔ [Registering an Address \(Folder \(FTP\) Address\) \(page 178\)](#)
- 2 [Save] > [OK]
Register the changed destination.

Editing Group Address in Address Book

Edit the destinations (group address) you added to the Address Book.

1 Display the screen.

- 1 [System Menu / Counter] key > [FunctionSettings] > [Address Book] > [Add/Edit Machine Address Book]
- 2 Select  (information icon) for the destination or group to edit.



NOTE

Destinations and group can be sorted or searched by destination name or address number.

➔ [Choosing from the Address Book \(page 270\)](#)

2 Edit a destination to a group.

- 1 Change "Name" and "Address Number".
➔ [Add the group \(page 180\)](#)
- 2 Change the destination.
Put a checkmark in the checkbox to select an item and remove the checkmark to cancel the selection.
- 3 [Save] > [OK]
Register the changed destination.

Deleting Address Book Entries

Delete the destinations (contacts) you added to the Address Book.

1 Display the screen.

- 1 [System Menu / Counter] key > [FunctionSettings] > [Address Book] > [Add/Edit Machine Address Book]
- 2 Select a destination or group to delete.



NOTE

Destinations and group can be sorted or searched by destination name or address number.

➔ [Choosing from the Address Book \(page 270\)](#)

2 [Delete] > [Delete]

Delete the contact or group.

Adding a Destination on One Touch Key

Assign a new destination (contact or group) to an one touch key.

NOTE

- Refer to the following for use of One Touch Key.
 - ➔ [Choosing from One Touch Key \(page 271\)](#)
- You can add One Touch Keys and edit their settings on Command Center RX.
 - ➔ **Command Center RX User Guide**
- If registering and editing of the One Touch Keys is restricted to administrators, you can edit the One Touch Keys by logging in with administrator privileges.
 - ➔ [Edit Restriction \(page 463\)](#)
 - ➔ **Command Center RX User Guide**

1 Display the screen.

[System Menu / Counter] key > [FunctionSettings] > [One-Touch Key] > [Add/Edit One-Touch Key]

2 Add One Touch Keys.

- 1 Select a One Touch Key number for the destination > [Add/Edit]

Enter a number in [Search (No.)] and select  (search icon) to display that One Touch Key.

Select a One Touch Key with no registered destination.

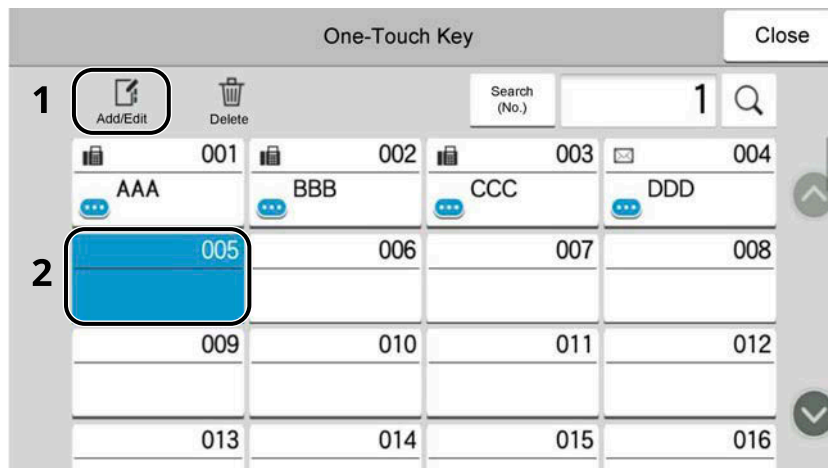

- 2 Enter the One Touch Key name displayed in the send base screen.

NOTE

For details on entering characters, refer to the following:

➔ [Character Entry Method \(page 748\)](#)

- 3 Select [Destination].

The Address Book appears.

- 4 Select a destination (contact or group) to add to the One Touch Key number > [OK]

Selecting  (information icon) shows the detailed information of the selected destination.

 **NOTE**

Destinations can be sorted or searched by destination name or address number.

➔ [Choosing from the Address Book \(page 270\)](#)

- 5 Select [OK].

The destination will be added to the One Touch Key.

Editing the Destination to the One Touch Key

1 Display the screen.

- 1 [System Menu / Counter] key > [FunctionSettings] > [One-Touch Key] > [Add/Edit One-Touch Key]

- 2 Select a One Touch Key number to edit > [Add/Edit]

Enter a number in [Search (No.)] and select  (search icon) to display that One Touch Key.

 **NOTE**

Select  (information icon) for the One Touch Key to display the information registered in the One Touch Key.

2 Change the Registered Information.

- 1 Change "Display Name".
-

 **NOTE**

For details on entering characters, refer to the following:

➔ [Character Entry Method \(page 748\)](#)

- 2 Select [Destination], and select a new destination (contact or group).  Selecting (information icon) shows the detailed information of the selected destination.
-

 **NOTE**

Destinations can be sorted or searched by destination name or address number.

➔ [Choosing from the Address Book \(page 270\)](#)

- 3 [OK] > [OK]

The destination will be added to the One Touch Key.

Deleting the Destination to the One Touch Key

1 Display the screen.

1 [System Menu / Counter] key > [FunctionSettings] > [One-Touch Key] > [Add/Edit One-Touch Key]

2 Select a One Touch Key number to delete.

Enter a number in [Search (No.)] and select  (search icon) to display that One Touch Key.

2 Delete the Registered Information.

[Delete] > [Delete]

The data registered in the One Touch Key is deleted.

4 Print from PC

Printer Driver Print Settings Screen

The printer driver print settings screen allows you to configure a variety of print-related settings.

➔ **Printer Driver User Guide**



1 [Quick Print] tab

Provides icons that can be used to easily configure frequently used functions. Each time you click an icon, it changes to an image resembling the print results and applies the settings.

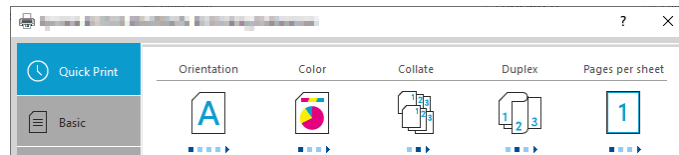

2 [Basic] tab

This tab groups basic functions that are frequently used. You can use it to configure the paper size, destination, and duplex printing.

3 [Layout] tab

This tab lets you configure settings for printing various layouts, including booklet printing, combine mode, poster printing, and scaling.

4 [Imaging] tab

This tab lets you configure settings related to the quality of the print results.

5 [Publishing] tab

This tab lets you create covers and inserts for print jobs and put inserts between sheets of OHP film.

6 [Job] tab

This tab lets you configure settings for saving print data from the computer to the machine. Regularly used documents and other data can be saved to the machine for easy printing later. Since saved documents can be printed directly from the machine, this function is also convenient when you wish to print a document that you don't want others to see.

7 [Advanced] tab

This tab lets you configure settings for adding text pages or watermarks to print data.

8 [Profiles]

Printer driver settings can be saved as a profile. Saved profiles can be recalled at any time, so it's a convenient practice to save frequently used settings.

9 [Reset]

Click to revert settings to their initial values.

Displaying the Printer Driver Help

The printer driver includes Help. To learn about print settings, open the printer driver print settings screen and display Help as explained below.

- 1 Click the [?] button in the upper right corner of the screen.

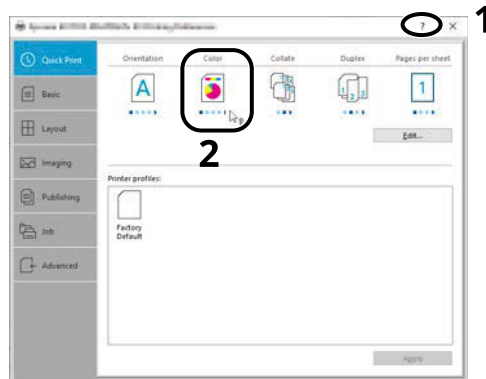

- 2 Click the item you want to know about.



NOTE

The Help appears, even when you click the item you want to know about and press the [F1] key on your keyboard.

Changing the Default Printer Driver Settings (Windows 10)

The default printer driver settings can be changed. By selecting frequently used settings, you can omit steps when printing. For the settings, refer to the following:

→ Printer Driver User Guide

- 1 Click [Start] button on the Windows and then select → [Windows System Tools], → [Control Panel], and → [Devices and Printers].
- 2 Right-click the printer driver icon of the machine, and click the [Printer properties] menu of the printer driver.
- 3 Click the [Basic] button on the [General] tab.
- 4 Select the default settings and click the [OK] button.

Changing the Default Printer Driver Settings (Windows 11)

The default printer driver settings can be changed. By selecting frequently used settings, you can omit steps when printing. For the settings, refer to the following:

→ Printer Driver User Guide

- 1 Click the [Start] button → [All apps] → [Windows Tools] → [Control Panel] → [Devices and Printers]
- 2 Right-click the printer driver icon of the machine, and click the [Printer properties] menu of the printer driver.
- 3 Click the [Basic] button on the [General] tab.
- 4 Select the default settings and click the [OK] button.

Changing the Default Printer Driver Settings (Windows 8.1, Windows 2012)

The default printer driver settings can be changed. By selecting frequently used settings, you can omit steps when printing. For the settings, refer to the following:

→ Printer Driver User Guide

- 1 Click [Settings] in the Charms Bar on Desktop → [Control Panel] → [Devices and Printers]
- 2 Right-click the printer driver icon of the machine, and click the [Printer properties] menu of the printer driver.
- 3 Click the [Basic] button on the [General] tab.
- 4 Select the default settings and click the [OK] button.

Printing from PC

This section provides the printing method using the KX DRIVER.

NOTE

- To print the document from applications, install the printer driver downloaded from Download Center (<https://kyocera.info/>) on your computer.
- In some environments, the current settings are displayed at the bottom of the printer driver.

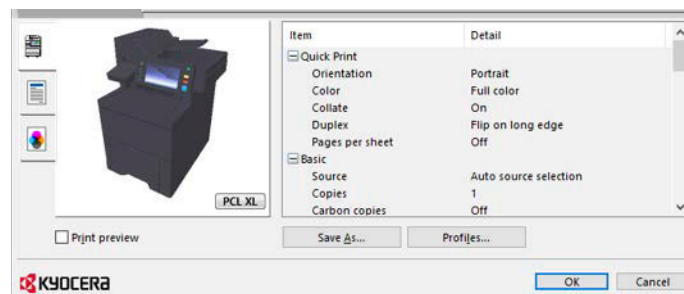

- When printing the cardstock or envelopes, load the cardstock or envelopes in the multipurpose tray before performing the following procedure.
➔ [Loading Paper in the Multipurpose Tray \(page 150\)](#)

Printing on Standard Sized Paper

If you loaded a paper size that is included in the print sizes of the machine, select the paper size in the [Basic] tab of the print settings screen of the printer driver.

NOTE

Specify the paper size and media type to print from the operation panel.

➔ [Paper Feeding \(page 430\)](#)

1 Display the screen.

Click [File] and select [Print] in the application.

2 Configure the settings.

1 Select the machine from the "Printer" menu and click the [Properties] button.

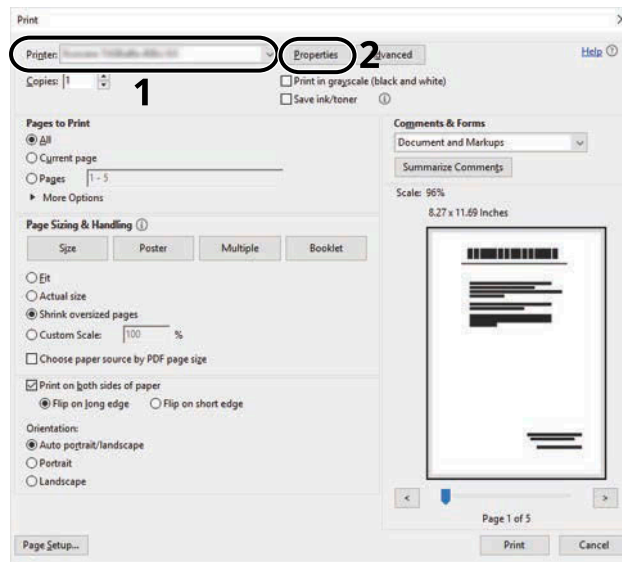

2 Select the [Basic] tab.

3 Click "Print size" menu and select the paper size to use for printing.

To load the paper of size that is not included in print sizes of the machine such as cardstock or envelopes, the paper size needs to be registered.

➔ [Printing on Non-standard Sized Paper \(page 196\)](#)

To print on the special paper such as thick paper or transparency, click "Media type" menu and select the media type.

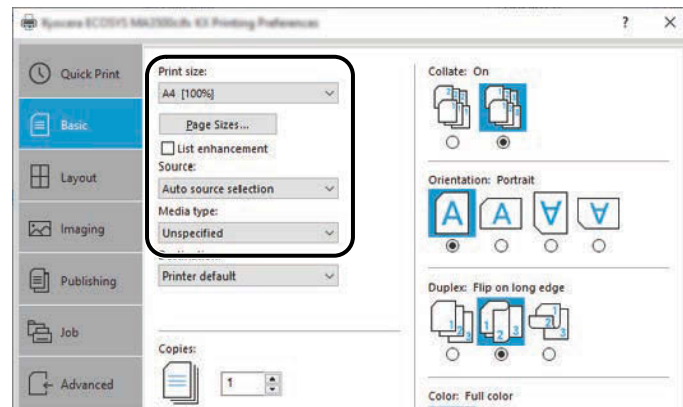

4 Click [OK] button to return to the Print dialog box.

3 Start printing.

Click the [OK] button.

Printing on Non-standard Sized Paper

If you loaded a paper size that is not included in the print sizes of the machine, register the paper size in the [Basic] tab of the print settings screen of the printer driver.

The registered size can be selected from the "Print size" menu.

NOTE

Specify the paper size and media type to print from the operation panel.

→ [Paper Feeding \(page 430\)](#)

1 Display the screen.

- 1 Select the Windows [Start] button → [Windows System Tool] → [Control Panel] → [Devices and Printers].

NOTE

- For Windows 11, select the [Start] button → [All apps] → [Windows Tools] → [Control Panel] → [Devices and Printers].
- For Windows 8.1, select [Settings] in the Charms Bar on Desktop → [Control Panel] → [Devices and Printers].

- 2 Right-click the printer driver icon of the machine, and click the [Printer properties] menu of the printer driver.
- 3 Click the [Preferences] button on the [General] tab.

2 Register the group.

- 1 Click the [Basic] tab.

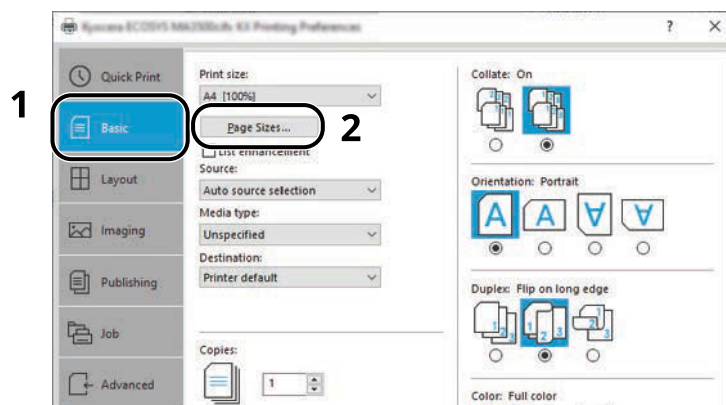

- 2 Click the [Page Size...] button.

- 3 Click the [New] button.

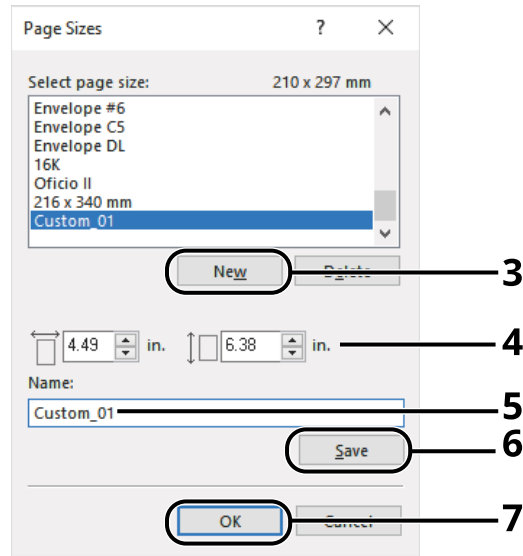

- 4 Enter the paper size.
- 5 Enter the name of the paper.
- 6 Click the [Add] button.
- 7 Click the [OK] button.
- 8 Click the [OK] button.

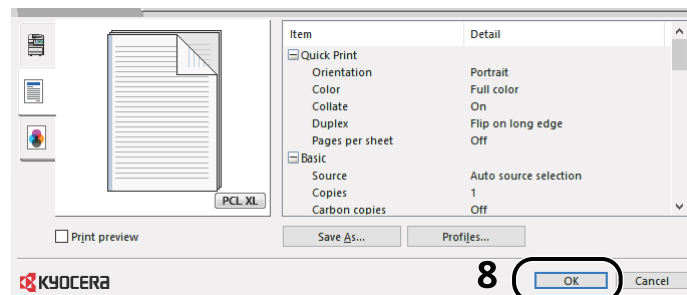

3 Display the print settings screen.

Click [File] and select [Print] in the application.

4 Select the paper size and type of non-standard size paper.

- 1 Select the machine from the "Printer" menu and click the [Properties] button.

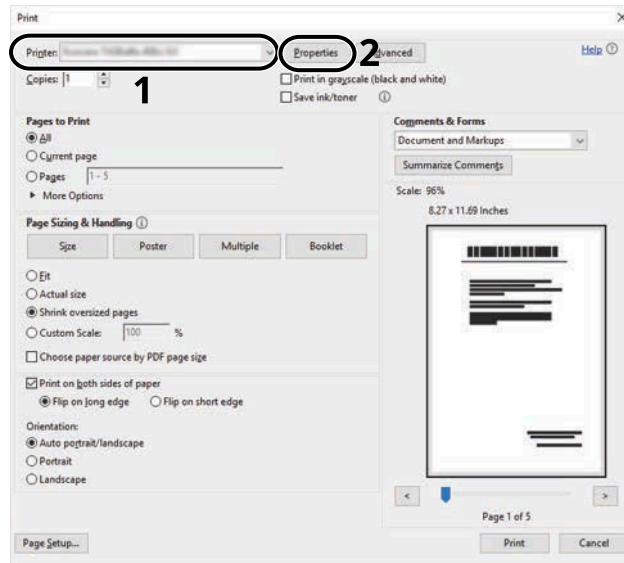

- 2 Select the [Basic] tab.
- 3 Click "Print size" menu and select the paper size registered in step 2.

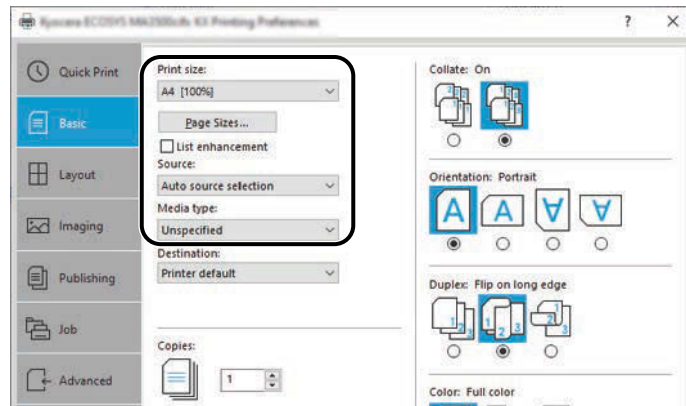

To print on the special paper such as thick paper or transparency, click [Media type] menu and select the media type.

NOTE

If you loaded a postcard or envelope, select [Cardstock] or [Envelope] in the "Media type" menu.

- 4 Select the paper source in the "Source" menu.
- 5 Click [OK] button to return to the Print dialog box.

5 Start printing.

Click the [OK] button.

Printing with Universal Print

Jobs can be printed via the cloud by using the cloud service "Universal Print" provided by Microsoft Corporation. Users authorized in the Azure Active Directory can print to Universal Print ready printers from anywhere.

NOTE

- A Microsoft 365 license and an Azure Active Directory account are necessary in order to use Universal Print. If you do not have one, please obtain these licenses and accounts.
 - In order to use Universal Print, the following prerequisites need to be met:
 - A Universal Print-eligible license must be assigned to the user account used
 - Printer Administrator or Global Administrator privileges must be assigned to all administrators
-

Registering the Machine to Universal Print

1 Start up the browser.

Specify `https://[Host name of this Machine]` and start Command Center RX.

2 Display the screen.

[Function Settings] > [Printer] > "Universal Print Settings" > [Settings]

3 Configure the settings.

- 1 Enter "Printer Name" in "Basic".
-

NOTE

Set the proxy if required.

➔ [Command Center RX User Guide](#)

- 2 Click [Register] in "Universal Print".
A Microsoft URL and an access code are displayed.
 - 3 Click the URL and enter the access code obtained in Step 2 > [Next]
 - 4 Log in as Azure administrator.
-

NOTE

Credential is required only when you register for the first time. Click [Approve].

- 5 Close the Microsoft web page and return to the Command Center RX screen.
 - 6 Click [OK].
Returns to the Universal Print Settings screen.
-

NOTE

Once registration is complete, [Register] in "Universal Print" will change to [Unregister], and the expiration date of certificate will be shown. Click [Refresh] if the display remains unchanged.

- 7 Click [Edit] in "Universal Print Preferences" and copy the unregister URL.
- 8 Open a new tab in the browser and past the URL.
You will be redirected to the Universal Print web page.
- 9 Click [Printers].
Registered printers are displayed.
- 10 Check the box for this machine and click [Share].
The "Shares printers" screen is displayed.
- 11 Select the users you want to share this machine with from the "Select member(s)" menu and click the [Share Printer] button.



NOTE

Enable [Allow access to everyone in my organization] to share this machine with all users in your organization.

- 12 Close the Universal Print web page.

Registering a Shared Printer to a Computer

To use Universal Print, it is necessary to add a shared printer registered with Universal Print to the computer.

1 Login

- 1 Select the Windows Start button → [Settings]→ [Accounts]→ [Access work or school].
- 2 Confirm that the Azure administrator account name is displayed in [Work or school account], and click it.



NOTE

If the Azure administrator account name is not displayed, click [+] (Connect), and use the Azure administrator account name and password to log in.

2 Display the screen.

Select [Home]→ [Devices]→ [Printers & scanners].

3 Configure the function.

- 1 Click [Add a printer or scanner].
- 2 Select the shared printer and click [Add device].
The shared printer is registered.

Print the Job

1 Display the screen.

Click [File] and select [Print] in the application.

2 Configure the settings.

- 1 Select a registered shared printer from the [Printer] menu and click the [Properties] button.

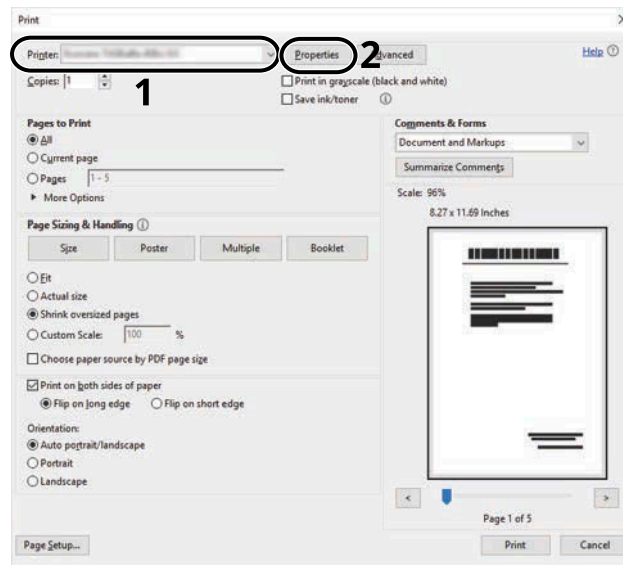

- 2 Set the paper size, printer function, etc., as desired.
- 3 Click [OK] button to return to the Print dialog box.

3 Start printing.

- Click the [OK] button.

Printing on Banner Paper

If you specify a paper size with a length of 488.1 mm or more (19.22" or more) and a maximum of 1,220 mm (48.03"), it will be treated as banner printing.

Maximum Loading Capacity	1 sheet (Multipurpose Tray)
Paper Width	210 mm to 216 mm (8.26" to 8.5")
Paper Length	488.1 mm to 1,220 mm (19.22" to 48.03")
Supported Paper Thickness	136 to 163 g/m ²
Media Type	Heavy 2

1 Display the screen.

Click [File] and select [Print] in the application.

2 Display the screen for registering the original size.

1 Select the machine from the "Name" menu and click the [Properties] button.

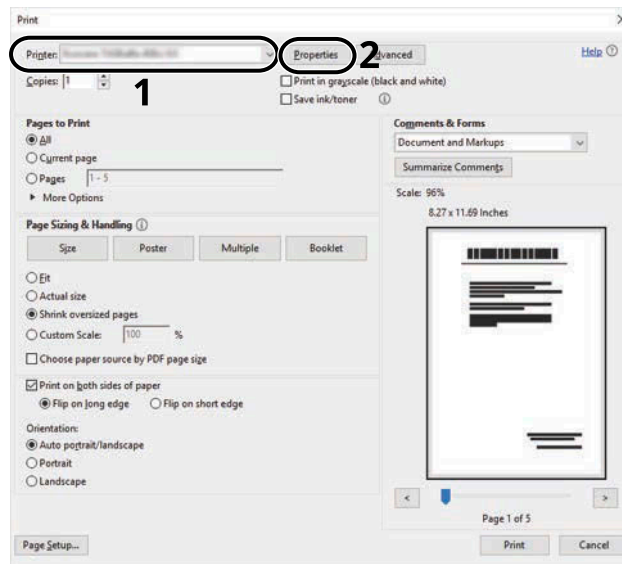

2 Select the [Basic] tab.

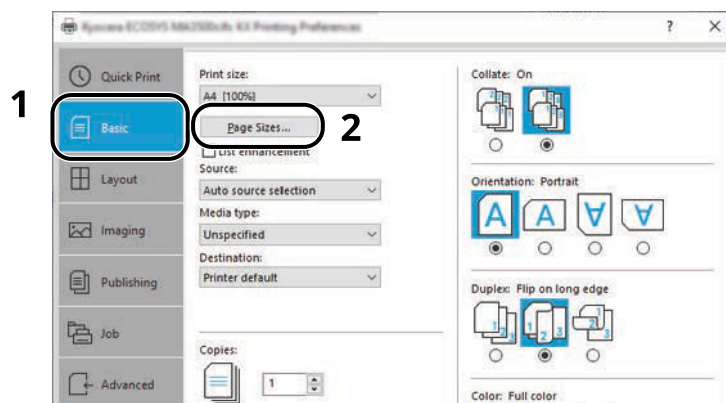

- 3 Select [Paper Size].

3 Register the original size.

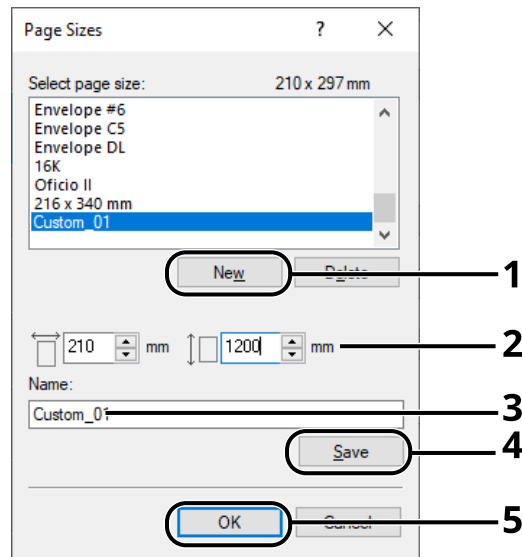

- 1 Click the [New] button.
- 2 Enter the length (488.1 mm or more) and width of the custom paper to be registered.
- 3 Enter the name of the paper.
- 4 Click the [Add] button.
- 5 Click the [OK] button.

4 Specify the print size.

- 1 Select the paper size registered in the "Print Size" menu.

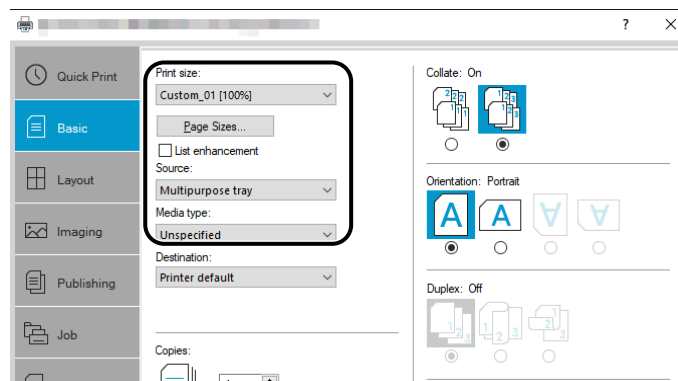

- 2 In the "Print Size" menu, select [Multipurpose Tray].
- 3 In the "Media Type" menu, select [Plain].

- 4 Click the [OK] button.



NOTE

For banner printing, the resolution is 600 dpi.

5 Load paper

- 1 Open the multipurpose tray and pull out the multipurpose tray extension.

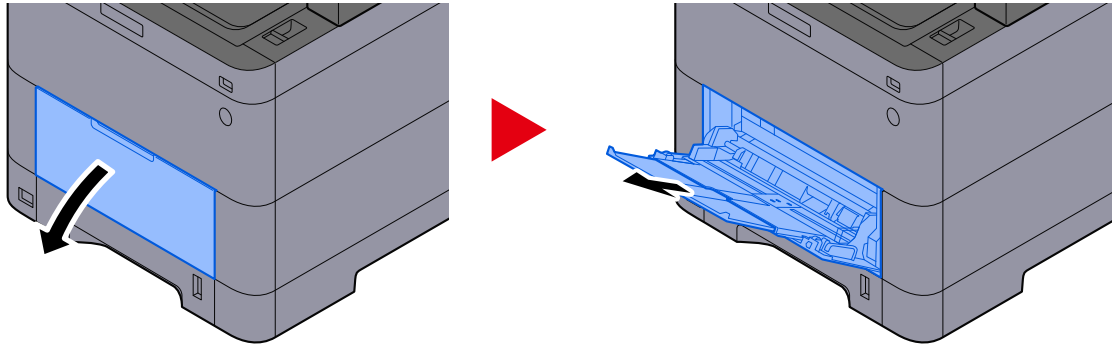

- 2 Load the banner sheets.

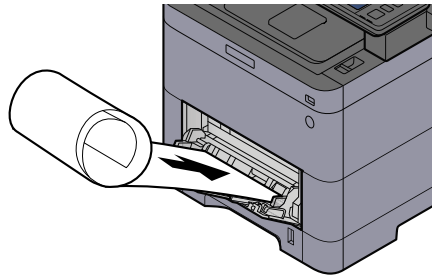

6 Print

Click the [OK] button.

When printing is executed, a message will be displayed on the operation panel of the machine. Load the paper in the multipurpose Tray and select [Continue] while supporting it so that it will not fall.

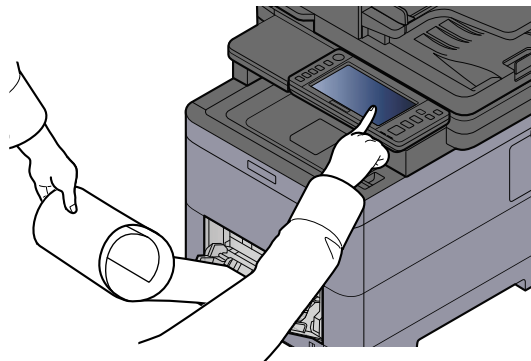

✔ **IMPORTANT**

- After selecting [Continue], support the paper with both hands so that the paper feeds correctly.

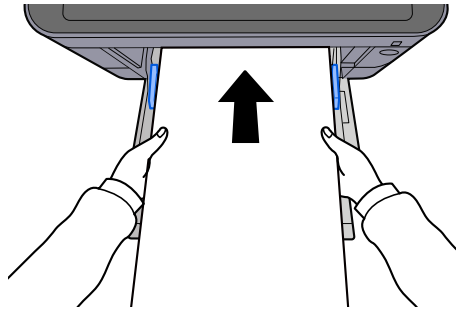

- After printing starts, catch the paper when it is output so that it does not fall out of the tray. When using the inner tray as the output location, do not stand up the stopper.

Set whether the confirmation screen appears before each sheet is printed when printing multiple sheets.

➔ [Message Banner Print \(page 468\)](#)

Canceling Printing from a Computer

To cancel a print job executed using the printer driver before the printer begins printing, do the following:

 **NOTE**

When canceling printing from this machine, refer to the following:

➔ [Canceling Jobs \(page 246\)](#)

-
- 1** Double-click the printer icon () displayed on the taskbar at the bottom right of the Windows desktop to display a dialog box for the printer.
 - 2** Click the file for which you wish to cancel printing and select [Cancel] from the "Document" menu.

Printing from the Mobile Device

This machine supports the AirPrint and Mopria. According to the supported OS and application, you can print the job from any mobile device or computer without installing a printer driver.

Printing by AirPrint

AirPrint is a printing function that is included standard in iOS 4.2 and later products, and Mac OS X 10.7 and later products. To use the AirPrint, make sure that the AirPrint setting is enabled in the Command Center RX.

➔ [Command Center RX User Guide](#)



Printing by Mopria

Mopria is a standard on printing function included in Android 4.4 or later products. Mopria Print Service needs to be installed and enabled in advance. For details on how to use, refer to a Web site of Mopria Alliance.



Printing with Wi-Fi Direct

Wi-Fi Direct is a wireless LAN standard that Wi-Fi Alliance has been established. This is one of the functions of the wireless LAN, without a wireless LAN access point or wireless LAN router, between devices can communicate directly on a peer to peer basis.

The printing procedure by the Wi-Fi Direct is the same as that from the normal mobile devices.

When you use a printer name or Bonjour name on the port settings of the printer property, you can print the job by specifying the name at Wi-Fi Direct connection. When you use an IP address for the port, specify the IP address of this machine.

Printing Data Saved in the Printer

You can save the print job into the Job Box of this device and print it as necessary. If you configure settings in the [Job] tab of the printer driver and then print, the print job will be saved in the Job Box (memory) and printing can be executed at the machine.

To print the job in Job Box, specify the Job Box from a computer and sending the print job, then specify a file within a Box and printing it, using the operation panel.

You can print the documents from the following boxes.

- Private Print Box
 - ➔ [Printing Documents from Private Print Box \(page 208\)](#)
- Stored Job Box
 - ➔ [Printing Document from Stored Job Box \(page 210\)](#)
- Quick Copy Box
 - ➔ [Printing Document from Quick Copy Box \(page 212\)](#)
- Proof and Hold Box
 - ➔ [Printing Document from Proof and Hold Box \(page 214\)](#)
- PIN Print Box
 - ➔ [Printing Documents from PIN Print Box \(page 215\)](#)
- Universal Print Box
 - ➔ [Printing the Documents Stored in the Universal Print Box \(page 217\)](#)

Specifying the Job Box from a Computer and Storing the Job

1 Click [File] and select [Print] in the application.

The Print dialog box displays.

2 Click the [▼] button of the Name to select the machine from the list.

3 Click the [Properties] button.

The Properties dialog box displays.

4 Click the [Job] tab and select the [Job storage (e-MPS)] check box to set the function.



NOTE

An optional SSD is required to use the Stored Job Box and the Quick Copy Box.

For information on how to use the printer driver software, refer to the following:

- ➔ **Printer Driver User Guide**
-

Printing Documents from Private Print Box

In Private Printing, you can specify that a job is not to be printed until you operate the machine. When sending the job from the application software, specify a password in the printer driver. The job is released for printing by entering the password on the operation panel, ensuring confidentiality of the print job. The data will be deleted upon completion of the print job or after the power switch is turned off.

1 Display the screen.

- 1 [Home] key > [Job Box]
- 2 Select [Private Print/Stored Job].
- 3 Select the creator of the document.

2 Print the document.

- 1 Select the document to print > [Print]
- 2 Enter the password.
- 3 Specify the number of copies to print as desired.
- 4 Select [Start Print].

Printing starts. Upon completion of printing, the Private Print job is automatically deleted.

Deleting the Documents Stored in the Private Print Box

1 Display the screen.

- 1 [Home] key > [Job Box]
- 2 Select [Private Print/Stored Job].
- 3 Select the creator of the document.

2 Delete the document.

- 1 Select the document to delete > [Delete]

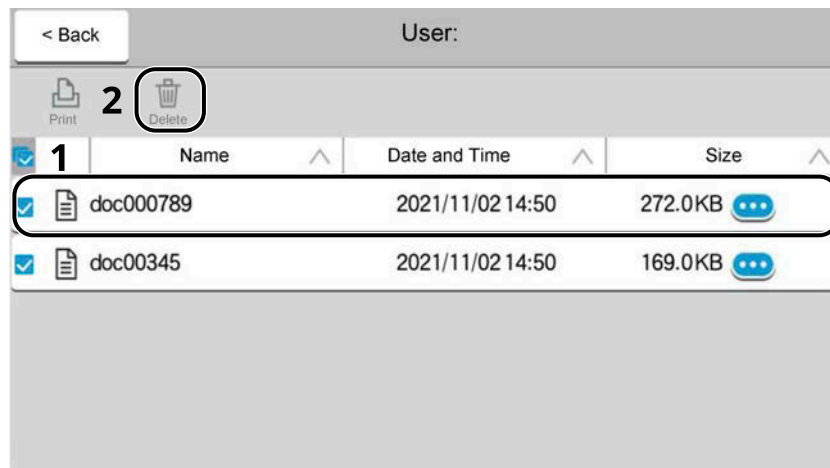

- 2 Enter the password.
The document is deleted.

Printing Document from Stored Job Box

In Stored Job, the print data sent from the application is saved to the machine. You can set up a password as necessary. If you set up a password, enter the password when printing. Print data will be stored in the Stored Job Box after printing. This will allow printing of the same print data repeatedly.

1 Display the screen.

- 1 [Home] key > [Job Box]
- 2 Select [Private Print/Stored Job].
- 3 Select the creator of the document.

2 Print the document.

- 1 Select the document to print > [Print]
- 2 Enter the password.
- 3 Specify the number of copies to print as desired.
- 4 Select [Start Print].

Printing starts.



NOTE

If the document is protected by a password, the password entry screen will be displayed. Enter the password.

Simple Job Printing

When you save a print job performed via user login to the Stored Job Box, logging in with an IC card at the time of printing displays a list of your print jobs in the Stored Job Box. When you run the print job, printing starts immediately.

User login administration that uses the optional IC Card Authentication Kit is required. For details on user login administration for printing, refer to the following:

- ➔ [Adding a User \(Local User List\) \(page 524\)](#)
- ➔ [Managing the Users that Print on This Machine from a PC \(page 528\)](#)

For IC card settings, refer to the following:

- ➔ [ID Card Settings \(page 547\)](#)

For Simple Job Printing settings, refer to the following:

- ➔ [Simple Job Printing \(page 548\)](#)

Deleting the Documents Stored in the Stored Job Box

1 Display the screen.

- 1 [Home] key > [Job Box]
- 2 Select [Private Print/Stored Job].
- 3 Select the creator of the document.

2 Delete the document.

- 1 Select the document to delete > [Delete]
- 2 If the document is protected by a password, enter the password.
The document is deleted.

Printing Document from Quick Copy Box

Quick Copy feature facilitates additional prints of a document already printed. Activating Quick Copy and printing a document using the printer driver allow the print data to be stored in the Quick Copy Job Box. When additional copies are required, you can reprint the required number of copies from the touch panel. By default, up to 32 documents can be stored. When power is turned off, all stored jobs will be deleted.

NOTE

- When the number of jobs reaches the limit, the oldest job will be overwritten by the new one.
- To maintain free space on the hard disk, you can set the maximum number of stored jobs.

➔ [Quick Copy Job Retention \(page 471\)](#)

1 Display the screen.

- 1 [Home] key > [Job Box]
- 2 Select [Quick Copy/Proof and Hold].
- 3 Select the creator of the document.

2 Print the document.

- 1 Select the document to print > [Print]
- 2 Specify the number of copies to print as desired.
- 3 Select [Start Print].

Printing starts.

Deleting the Documents Stored in the Quick Copy Box

1 Display the screen.

- 1 [Home] key > [Job Box]
- 2 Select [Quick Copy/Proof and Hold].
- 3 Select the creator of the document.

2 Delete the document.

Select the document to delete > [Delete] > [Delete]

The document is deleted.

Printing Document from Proof and Hold Box

The Proof and Hold feature produces only a single proof print of multiple-print job and holds printing of the remaining copies. Printing a multiple-print job in Proof and Hold using the printer driver allows only a single copy to be printed while maintaining the document data in the Job Box. To continue to print the remaining copies, use the touch panel. You can change the number of copies to print.

1 Display the screen.

- 1 [Home] key > [Job Box]
- 2 Select [Quick Copy/Proof and Hold].
- 3 Select the creator of the document.

2 Print the document.

- 1 Select the document to print > [Print]
- 2 Specify the number of copies to print as desired.
- 3 Select [Start Print].

Printing starts.

Deleting the Documents Stored in the Proof and Hold Box

1 Display the screen.

- 1 [Home] key > [Job Box]
- 2 Select [Quick Copy/Proof and Hold].
- 3 Select the creator of the document.

2 Delete the document.

Select the document to delete > [Delete] > [Delete]

The document is deleted.

Printing Documents from PIN Print Box

This PIN Print Box holds printing when printing is executed from applications that use the IPP protocol, such as AirPrint and Mopria. A pending print job can be output by entering the PIN code that was set at the time of printing.

1 Display the screen.

- 1 [Home] key > [Job Box]
- 2 Select [PIN Print].
- 3 Select the creator of the document.

2 Print the document.

- 1 Select the document to print > [Print]
 - 2 Enter the PIN code.
 - 3 Select [Print].
- Printing starts.

Deleting the Documents Stored in the PIN Print Box

1 Display the screen.

- 1 [Home] key > [Job Box]
- 2 Select [PIN Print].
- 3 Select the creator of the document.

2 Delete the document.

- 1 Select the document to delete > [Delete]
 - 2 Enter the PIN code.
 - 3 Select [Delete].
- The document is deleted.

Printing Document from Universal Print Box

For added security, Universal Print can set a PIN code for the printing jobs. Jobs with a PIN code will be saved in the cloud without being printed. By entering the PIN code from the operation panel, jobs from this machine can be printed.

NOTE

- To use Universal Print, this machine must be registered as a shared printer.
 - ➔ [Registering the Machine to Universal Print \(page 199\)](#)
- To use the Universal Print box, you need a Windows 11 and Microsoft 365 license and an Azure Active Directory account.

Storing a Job in the Universal Print Box

1 Display the screen.

Click [File] and select [Print] in the application.

2 Configure the settings.

- 1 Select a registered shared printer from the "Printer" menu and click the [Properties] button.

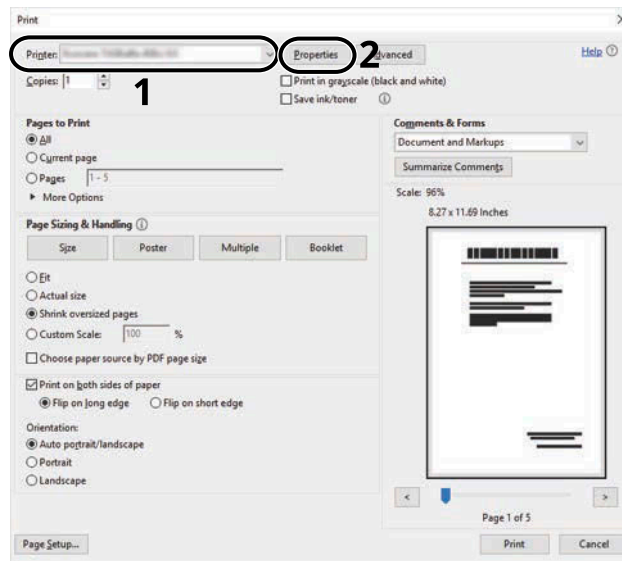

- 2 Select [Advanced settings].

- 3 Set [PIN-protected printing] to [On], and set a PIN code (4 digits) as the [PIN-protected printing PIN].

- 4 Click [OK] button > [OK] button to return to the Print dialog box.

3 Start printing.

Click the [OK] button.

Printing the Documents Stored in the Universal Print Box

1 Display the screen.

- 1 Select [Universal Print] in the Home screen.
- 2 Select the creator of the document.

2 Print the document.

- 1 Select the document to print > [Print]
- 2 Enter the PIN code.
- 3 Select [Start Print].

Printing starts.

Upon completion of printing, the Universal Print data is automatically deleted.

Deleting the Documents Stored in the Universal Print Box

1 Display the screen.

- 1 Select [Universal Print] in the Home screen.
- 2 Select the creator of the document.

2 Delete the document.

- 1 Select the document to delete > [Delete]
- 2 Enter the PIN code.
- 3 Select [Delete].

The document is deleted.

Monitoring the Printer Status (Status Monitor)

The Status Monitor monitors the printer status and provides an ongoing reporting function.

NOTE

When you activate Status Monitor, check the status below.

- KX DRIVER is installed.
- Either [Enhanced WSD] or [Enhanced WSD over TLS] is enabled.

➔ [Protocol Settings \(page 488\)](#)

Accessing the Status Monitor

The Status Monitor also starts up when printing is started.

Exiting the Status Monitor

Use either of the methods listed below to exit the Status Monitor.

Exit manually

Click the settings icon and select Exit in the menu to exit the Status Monitor.

Exit automatically

The Status Monitor automatically shuts down after 7 minutes if it is not being used.

Quick View State

The status of the printer is displayed using icons. Detailed information is displayed when the Expand button is clicked.

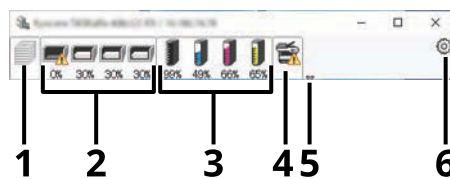

- 1 Printing progress tab
- 2 Paper tray status tab
- 3 Toner Status Tab
- 4 Alert tab
- 5 Expand button
- 6 Settings icon

Detailed information is displayed by clicking on each icon tab.

Printing progress tab

The status of the print jobs is displayed.

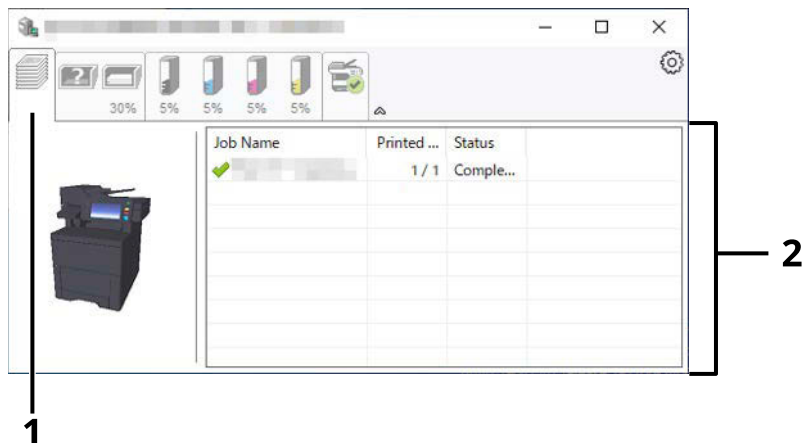

1 Status icon

2 Job list

Select a job on the job list and it can be canceled using the menu displayed with a right-click.

Paper tray status tab

Information is displayed about the paper in the printer and about the amount of paper remaining.

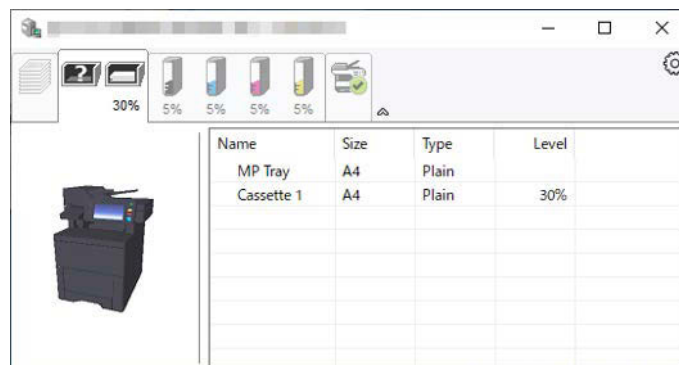

Toner Status Tab

The amount of toner remaining is displayed.

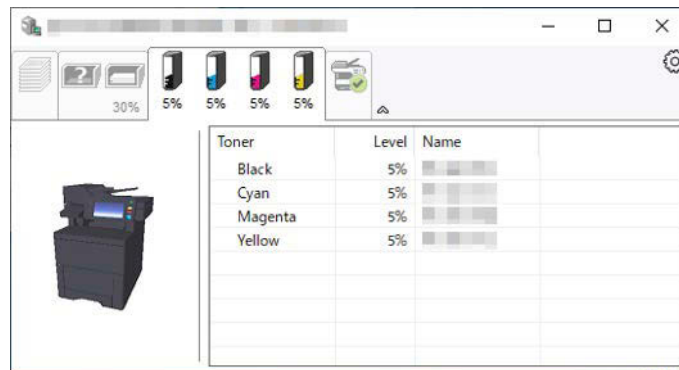

Alert tab

If an error occurs, a notice is displayed using a 3D image and a message.

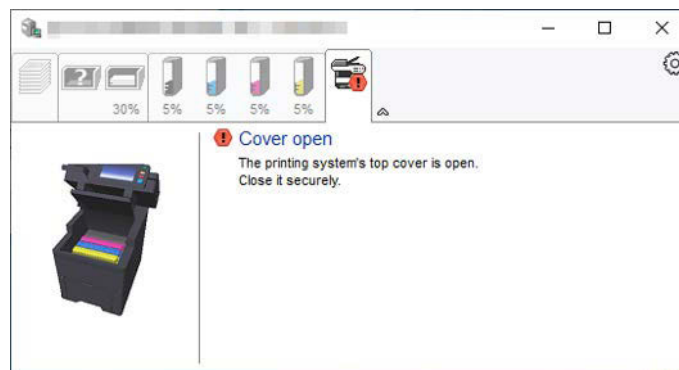

Status Monitor Context Menu

The following menu is displayed when the settings icon is clicked.

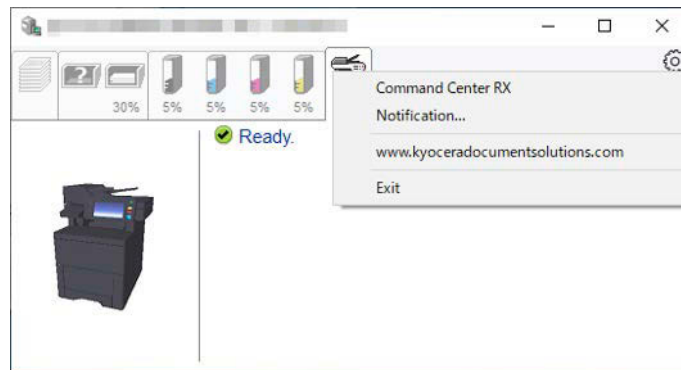

[Command Center RX]

If the printer is connected to a TCP/IP network and has its own IP address, use a web browser to access the Command Center RX to modify or confirm the network settings. This menu is not displayed when using USB connection.

➔ [Command Center RX User Guide](#)

[Notification...]

This sets the display of the Status Monitor.

➔ [Status Monitor Notification Settings \(page 222\)](#)

[www.kyoceradocumentsolutions.com]

Open our website.

[Exit]

Exits the Status Monitor.

Status Monitor Notification Settings

The Status Monitor settings and event list details are displayed.

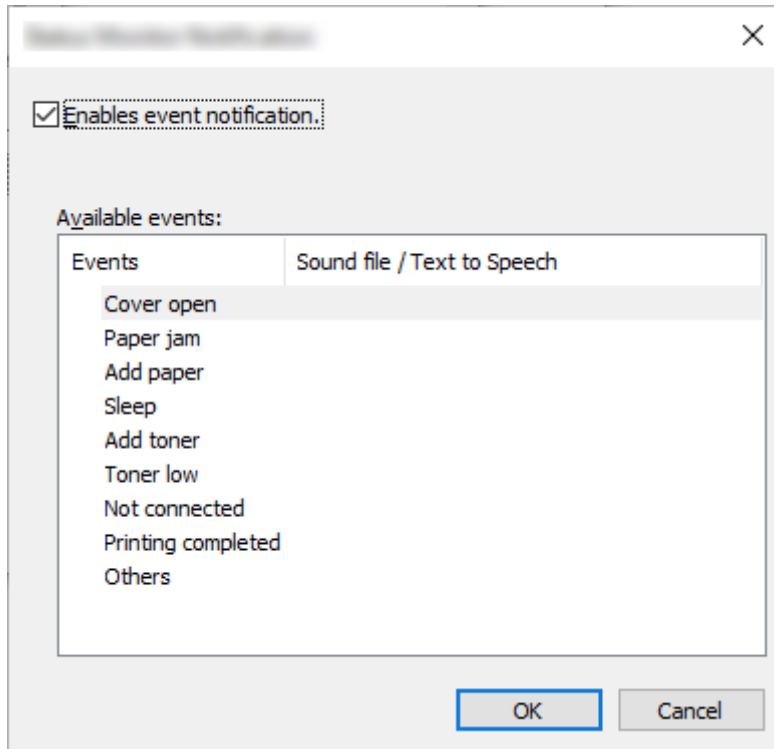

Select whether notification is performed when an error in the event list occurs.

1 Select "Enable event notification".

If this setting is set to Off, then the Status Monitor will not start up even when printing is executed.

2 Select an event to use with the text to speech function in Available events.

3 Click "Sound file / Text to Speech" column.

Click the browse (...) button to notify the event by sound file.

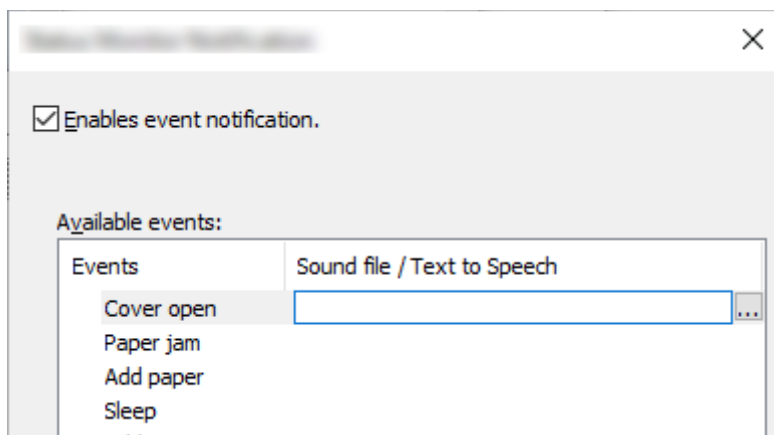



NOTE

The available file format is WAV.

When customizing the message texts to read on the screen aloud, enter the texts in the text box.

5 Operation on the Machine

Loading Originals

Load the originals on the platen or document processor, depending on the original size, type, volume, and function.

Platen

Place the sheet, book, postcards, and envelopes.

Document processor

Place the multiple originals. You can also place the two sided originals.

Placing Originals on the Platen

You may place books or magazines on the platen in addition to ordinary sheet originals.

1 Put the scanning side facedown.

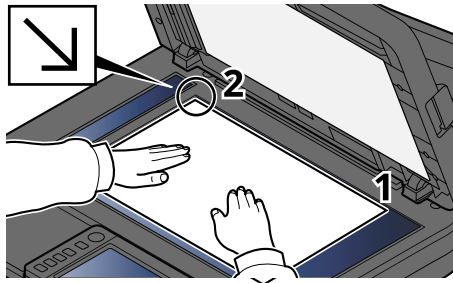

2 Align it flush against the original size indicator plates with the back left corner as the reference point.



NOTE

For details on Original Orientation, refer to the following:

➔ [Original Size \(page 321\)](#)

Placing Envelopes or Cardstock on the Platen

- 1 Put the scanning side facedown.

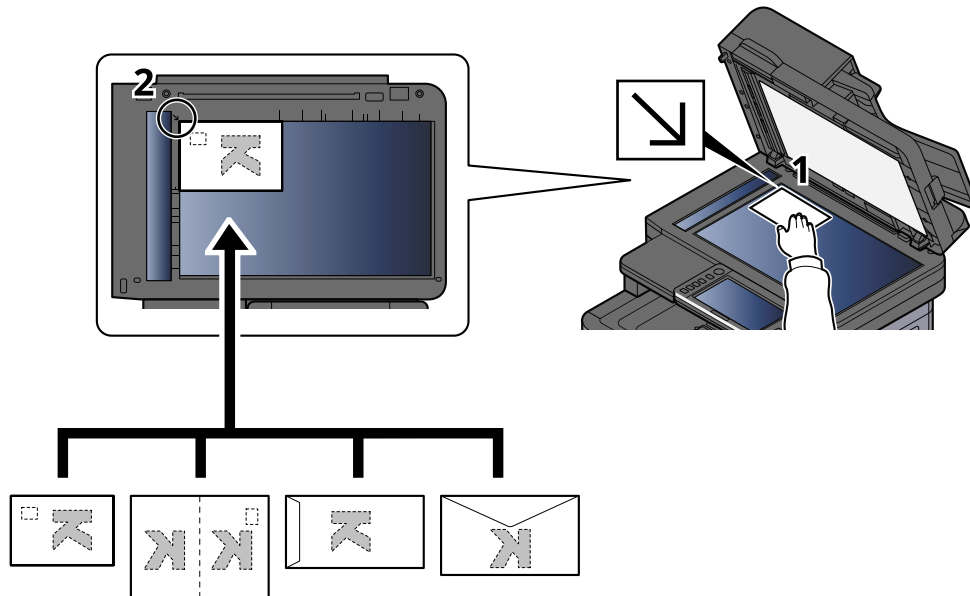

- 2 Align it flush against the original size indicator plates with the back left corner as the reference point.



NOTE

For the procedure for feeding envelopes or cardstock, refer to the following:

➔ [Loading Paper in the Multipurpose Tray \(page 150\)](#)



CAUTION

Do not leave the Document Processor open. Doing so may cause injury.



IMPORTANT

- Do not push the document processor forcefully when you close it. Excessive pressure may crack the platen glass.
- When placing books or magazines on the machine, do so with the document processor in the open position.

Original Specifications available in the Document Processor

The document processor automatically scans each sheet of multiple originals. Both sides of two-sided originals are scanned.

Originals Supported by the Document Processor

The document processor supports the following types of originals.

Setting	Description
Thickness	50 to 120 g/m ² (duplex: 50 to 120 g/m ²)
Size	Maximum Folio (Legal) to Minimum A6-R (Statement-R)
No. of sheets	100 sheets (50 to 80 g/m ²) maximum

Originals Not Supported by the Document Processor

Do not use the document processor for the following types of originals. Otherwise, the originals may be jammed or the document processor may become dirty.

- Originals bound with clips or staples (Remove the clips or staples and straighten curls, wrinkles or creases before loading. Failure to do so may cause the originals to jam.)
- Originals with adhesive tape or glue
- Originals with cut-out sections
- Curled original
- Originals with folds (Straighten the folds before loading. Failure to do so may cause the originals to jam.)
- Carbon paper
- Crumpled paper

Loading Originals in the Document Processor

✔ IMPORTANT

- Before loading originals, be sure that there are no originals left on the original eject table. Originals left on the original eject table may cause the new originals to jam.
 - Do not make an impact on the document processor top cover, such as aligning the originals on the top cover. It may cause an error in the document processor.
-

1 Adjust the original width guides.

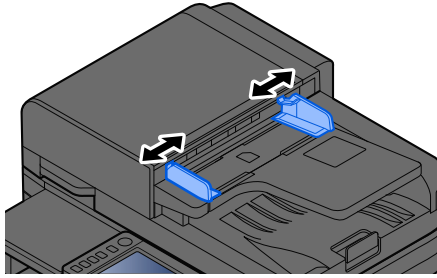

2 Place the original.

- 1 Put the side to be scanned (or the first side of two-sided originals) face-up. Slide the leading edge into the document processor as far as it will go.

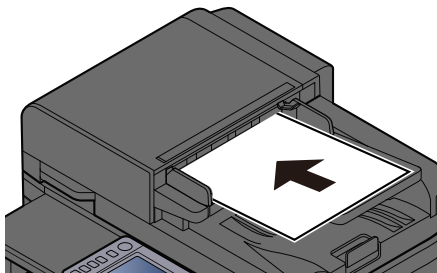

NOTE

For details on Original Orientation, refer to the following:

➔ [Original Orientation \(page 328\)](#)

 **IMPORTANT**

Confirm that the original width guides exactly fit the originals. If there is a gap, readjust the original width guides. The gap may cause the originals to jam.

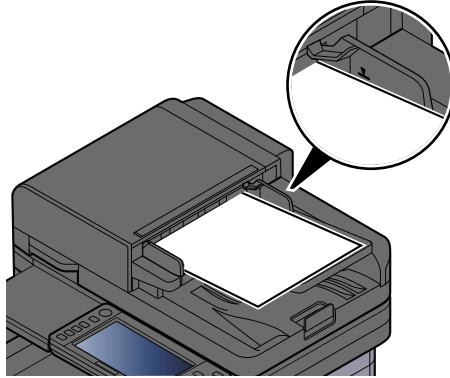

Ensure that loaded originals do not exceed the level indicator. Exceeding the maximum level may cause the originals to jam.

Originals with punched holes or perforated lines should be placed with the punched holes or perforated lines on the right side (so that they will be scanned last).

- 2 Open the original stopper to fit the size of the original set.

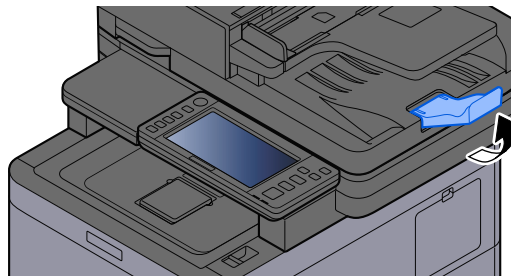

Recalling Frequently Used Functions (Favorites)

After you add frequently used functions to Favorites, you can recall them quickly and easily.

Favorites are registered by selecting from two types of recalling methods.

- Wizard Mode (Selection Dialog): Recall the registered settings in order and configure while confirming or modifying them.
- Program Mode: When you select a key registered as a favorite, the setting is recalled immediately.

The favorites below have been preregistered. The registered contents can be re-registered for easier use in your environment.



NOTE

- Up to 20 functions combining copying and sending can be registered in the favorites.
 - If user login administration is enabled, you can only register functions by logging in with administrator privileges.
-

ID Card Copy

Use this when you want to copy a driver's license or an insurance card. When you scan the front and back of the card, both sides will be combined and copied onto a single sheet.

Default Registration

- Copy Functions
- ID Card Copy
- Color Selection: [Black & White]
- Paper Selection: [Cassette 1]
- Zoom: [100%]

Paper Saving Copying

Use when you want to save paper. Follow the instructions on the screen to configure page aggregation or 2-sided copying.

Default Registration

- Copy Functions
- Color Selection: [Black & White]
- Combine: [2 in 1]
- Duplex: [1-sided>>2-sided]
- Paper Selection: Cassette 1
- Number of copies printed: 1

Simple Sending Job Folder (Destination Entry)

Use when you want to send images to a shared folder on any computer or to a folder on the FTP server. Follow the instructions on the screen to configure the settings, such as the destination or color selection.

Default Registration

- Sending Function
- Destination: New Folder
- Color Selection: [Auto Color (Color/Grayscale)]
- File Name Entry: Default value
- File Format: [PDF]
- Continuous Scan: On
- Scan Resolution: [300x300dpi]

Simple Sending Job Folder (Address Book)

Use when you want to send images to a shared folder on a computer registered in the address book or to a folder on the FTP server. Follow the instructions on the screen to configure the settings, such as the destination or color selection.

Default Registration

- Sending Function
- Destination: Address Book
- Color Selection: [Auto Color (Color/Grayscale)]
- File Name Entry: Default value
- File Format: [PDF]
- Continuous Scan: On
- Scan Resolution: [300x300dpi]

Simple Sending Email (Destination Entry)

Use when you want to send images to any email address. Follow the instructions on the screen to configure the settings, such as the destination or color selection.

Default Registration

- Sending Function
- Destination: New Email Address
- Color Selection: [Auto Color (Color/Grayscale)]
- File Name Entry: Default value
- File Format: [PDF]
- Continuous Scan: On
- Scan Resolution: [300x300dpi]
- Email Subject: Default Value
- Email Body: Default Value

Simple Sending Email (Address Book)

Use when you want to send images to an email address registered in the address book. Follow the instructions on the screen to configure the settings, such as the destination or color selection.

Default Registration

- Sending Function
- Destination: Address Book
- Color Selection: [Auto Color (Color/Grayscale)]
- File Name Entry: Default value
- File Format: [PDF]
- Continuous Scan: On
- Scan Resolution: [300x300dpi]
- Email Subject: Default Value
- Email Body: Default Value

Register Favorites (Wizard Mode)

The following procedure is an example of registering the copying function.

1 Display the screen.

- 1 [Home] key > [Copy]
- 2 Select [Favorites].

2 Register Favorites.

- 1 [Add] > Select a number (01 to 20) for the favorite number.



NOTE

If you register on a favorite number already registered, delete the currently registered favorite before registering.

- 2 Select [Wizard].
- 3 Select the function to recall > [Next >]
- 4 Enter the new favorite name > [Register]

The favorite is registered.

To display a registered favorite on the Home screen, select [Add] on the confirmation screen that appears.

- 5 Select [OK].

Register Favorites (Program Mode)

When selecting the program format, first set the copy function, transmission function, fax function, destination, etc. to be registered.

1 Display the screen

- 1 Select [Copy] in the Home screen.
- 2 Select [Favorites] while the copy mode is accessed.

2 Register Favorites.

- 1 [Add] > Select a number (01 to 20) for the favorite number.



NOTE

If you register on a favorite number already registered, delete the currently registered favorite before registering.

- 2 Select [Program].
 - 3 Enter the new favorite name > [Register]
- The favorite is registered.

To display a registered favorite on the Home screen, select [Add] on the confirmation screen that appears.

- 4 Select [OK].

Recalling Favorites (Program Mode)

1 Recall the favorite.

- 1 Select [Favorites] of the task bar of the home screen or [Favorites] of the [Copy] functions screen, the [Send] functions screen, or the like, or select a registered favorites icon.

If you selected the icon of a favorite, that favorite will be recalled. If you selected [Favorites], proceed to the next step.

- 2 Select the number of the favorite you want to recall.

Select [Search], enter the number of the favorite (01 to 20), and select [OK] to call up that favorite.



NOTE

If the favorite cannot be recalled, the Document Box or the form overlay specified in the favorite might have been deleted. Check the Document Box.

2 Execute the favorite.

Place the originals > [Start] key

Recalling Favorites (Wizard Mode)

1 Recall the favorite.

- 1 Select [Favorites] of the task bar of the home screen or [Favorites] of the [Copy] functions screen, the [Send] functions screen, or the like, or select a registered favorites icon.

If you selected the icon of a favorite, that favorite will be recalled. If you selected [Favorites], proceed to the next step.

- 2 Select the favorite number you want to recall.

Select [Search], enter the favorite number (01 to 20), and select [OK] to call up that favorite.



NOTE

If the favorite cannot be recalled, the Document Box or the form overlay specified in the favorite might have been deleted. Check the Document Box.

2 Execute the favorite.

- 1 The screens will be displayed in order, so make the settings then select [>].

After setting to the end, a confirmation screen will be displayed.



NOTE

If you need to change the settings, select [<] and change the settings.

- 2 Place the originals > [Start] key

Editing Favorites

You can change favorite number and favorite name.

1 Display the screen.

- 1 [Home] key > [...] > [Favorites]
- 2 Select [Edit].

2 Edit the favorite.

- 1 Select corresponding to the favorite number (01 to 20) to change.
- 2 Select [Edit] to change the favorite number and favorite name.
➔ [Register Favorites \(Wizard Mode\) \(page 233\)](#)
- 3 [OK] > [OK]

Deleting Favorites

1 Display the screen.

- 1 [Home] key > [...] > [Favorites]
- 2 Select [Edit].

2 Deleting Favorites.

- 1 Select corresponding to the favorite number (01 to 20) to delete.
- 2 [Delete] > [Delete]

Using Applications

The functionality of the machine can be expanded by installing applications.

Applications that help you perform your daily more efficiently such as a scan feature and an authentication feature are available.

For details, contact your sales representative or dealer.

Installing Applications

To use applications, first install the application in the machine and then activate the application.



NOTE

You can install applications and certificates on the machine. The number of applications you can run may vary according to the type of application.

1 Display the screen.

[System Menu / Counter] key > [Add/DeleteApplication] > "Application" [Add/Delete Application]



NOTE

If the user authentication screen appears, log in with a user who has the privilege to configure this setting. If you do not know your login user name or password, please contact your administrator.

2 Install an application.

1 [Add] > [OK]

2 Insert the USB drive containing the application to be installed into the USB Memory Slot.



NOTE

If "USB Drive is recognized. Displaying files." is displayed, select [Cancel].

3 Select the application to be installed >

You can view detailed information on the selected application by selecting  (information icon).

4 Select [Yes] on the confirmation screen.

Installation of the application begins. Depending on the application being installed, the installation may take some time.

Once the installation ends, the original screen reappears.



NOTE

- To install another application, repeat steps 2-3 and 2-4.
 - To remove the USB drive, select [Remove USB Drive], and remove the USB Drive after "USB Drive can be safely removed." is displayed.
-

Activating Applications

1 Display the screen.

[System Menu / Counter] key > [Add/DeleteApplication] > "Application" [Add/Delete Application]



NOTE

If the user authentication screen appears, log in with a user who has the privilege to configure this setting. If you do not know your login user name or password, please contact your administrator.

2 Select the desired application > [Activate]

You can view detailed information on the selected application by selecting  (information icon).

3 Enter the license key > [Official]

Some applications do not require you to enter a license key. If the license key entry screen does not appear, go to step 4.

To use the application as a trial, select [Trial] without entering the license key.

4 Select [Start] in the confirmation screen.



IMPORTANT

- If you change the date/time while using the trial version of an application, you will no longer be able to use the application.
 - Icons of activated application are displayed in the Home screen.
-

5 Select the application icon in the Home screen.

Select the application icon.

The application will start up.

Deactivating Applications

1 Display the screen.

[System Menu / Counter] key > [Add/DeleteApplication] > "Application" [Add/Delete Application]



NOTE

If the user authentication screen appears, log in with a user who has the privilege to configure this setting. If you do not know your login user name or password, please contact your administrator.

2 Deactivate the application.

Select the application you wish to deactivate and select [Deactivate].



NOTE

- Select [x] on the screen if you want to exit the application running.
 - The procedure for exiting some applications may differ.
-

Uninstalling Applications

1 Display the screen.

[System Menu / Counter] key > [Add/DeleteApplication] > "Application" [Add/Delete Application]



NOTE

If the user authentication screen appears, log in with a user who has the privilege to configure this setting. If you do not know your login user name or password, please contact your administrator.

2 Delete the application.

1 Select the application you want to delete > [Delete]

You can view detailed information on the selected application by selecting  (information icon).

2 Select [Yes].

Registering Shortcuts (Copy, Send, and Document Box Settings)

You can register shortcuts for easy access to the frequently used functions. A function name linked to a registered shortcut can be changed as necessary.

Creating new shortcuts

New shortcuts can be created in the basic screen of each function.

1 Display the basic screen you want to register.

2 Register the shortcuts.

1 Select [⏪] from "Shortcut".

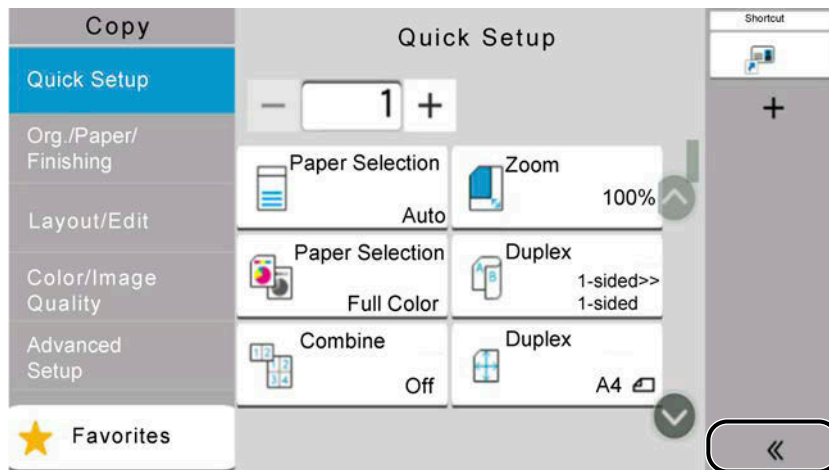

2 Select [✎] (edit icon).

The Add/Edit Shortcut screen is displayed.

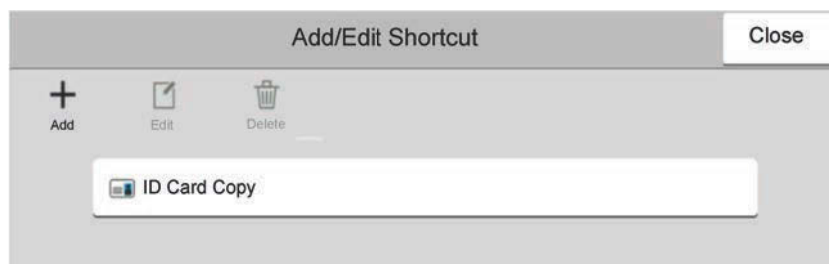

3 Select [Add].

4 Select the function you want to register > [Next >]

5 Enter the shortcut name > [Next >]

 **NOTE**

The function name will be displayed if you do not enter a shortcut name.

6 Confirm the entry.

Select [Shortcut Name], [Function], or [Permission] to change the settings.

 **NOTE**

[Permission] is displayed when the user login administration is enabled.

- 7 Select [Finish].
The shortcut is registered.

Editing Shortcuts

Shortcut editing is performed in the basic screen of each function.

- 1 Display the basic screen you want to register.
- 2 Register the shortcuts.

- 1 Select [≪≪] from "Shortcut".

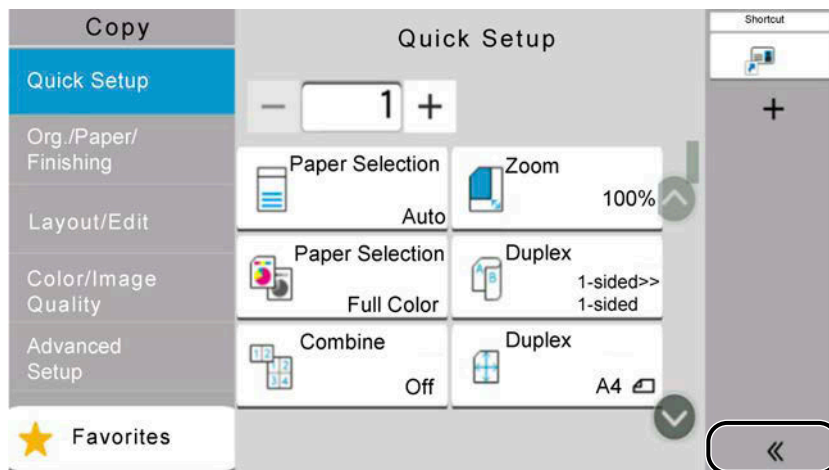

- 2 Select  (edit icon).
The Add/Edit Shortcut screen is displayed.

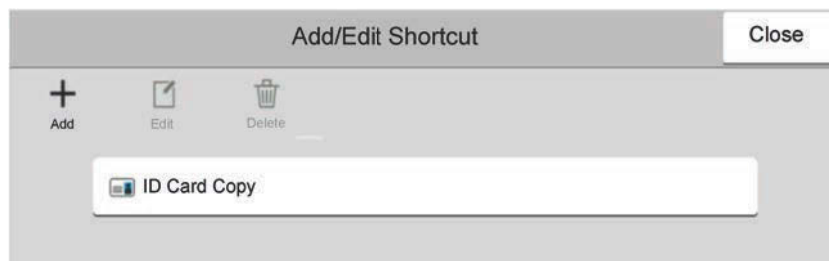

- 3 Select [Edit].
- 4 [Shortcut Name] or [Function] > Change the Settings > [OK]
- 5 [Finish] > [Update]

Deleting Shortcuts

Shortcut deletion is performed in the basic screen of each function.

1 Display the basic screen you want to register.

2 Register the shortcuts.

1 Select [⏪] from "Shortcut".

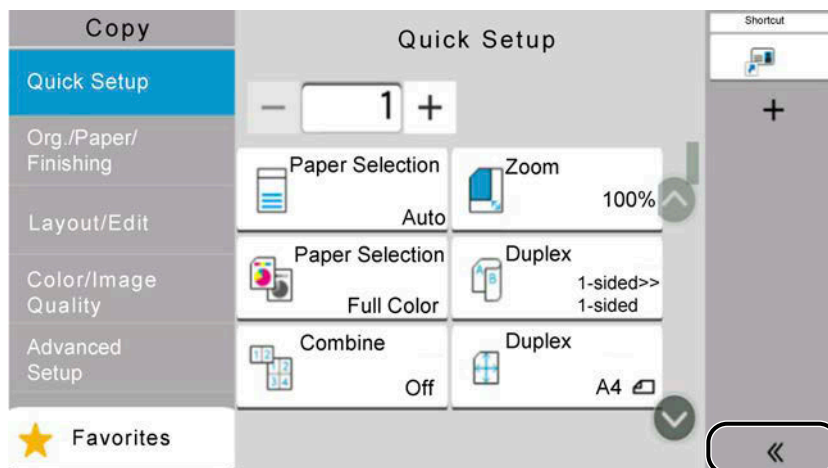

2 Select [✎] (edit icon).

The Add/Edit Shortcut screen is displayed.

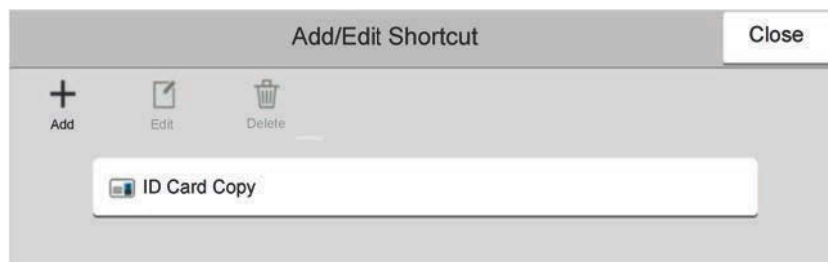

3 Select the shortcut you want to delete > [Delete] > [Delete]

Copying

The procedures here represent the basic copy operation and how to cancel the copy.

Basic Operation

- 1 [Home] key > [Copy]
- 2 Place the original.

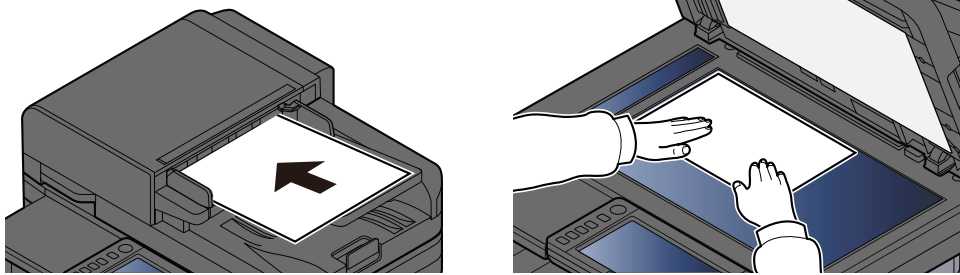

➔ [Loading Originals \(page 225\)](#)

- 3 Configure the functions.

To configure the settings for functions, select the Global Navigation.

➔ [About Functions Available on the Machine \(page 303\)](#)

- 4 Use the numeric keys to enter the copy quantity.

Select the area for inputting the number of sheets to display the numeric keypad. Or, use [+] or [-] to enter the number of sheets. Specify the desired number up to 9999.

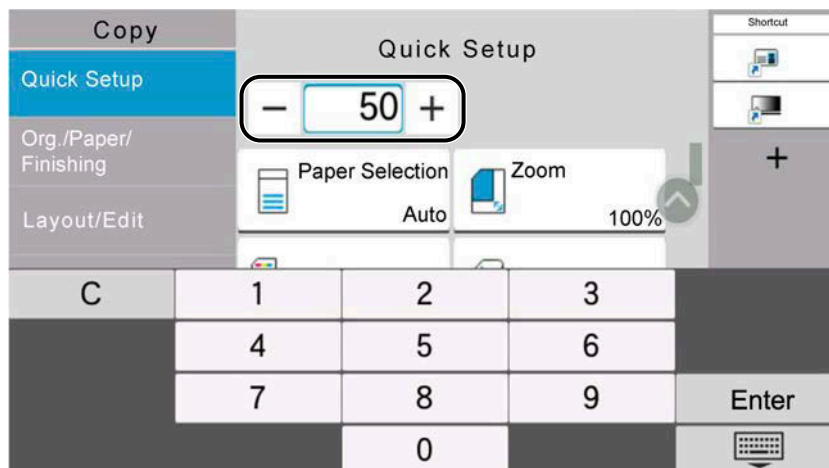

- 5 Press the [Start] key.

Copying begins.

NOTE

This function allows you to reserve the next job during printing. When the current print job ends, the reserved copy job is printed. If "Reserve Next Priority" is set to Off, [Reserve Next] will appear. Select [Reserve Next] and configure the necessary settings for the copy job.

➔ [Reserve Next Priority \(page 452\)](#)

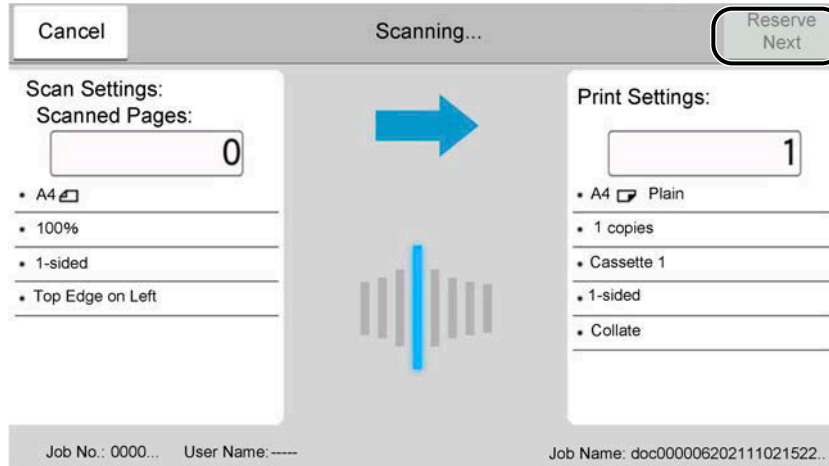

Canceling Jobs

1 Select the [Stop] key with the copy screen displayed.

2 Cancel a job.

When there is a job is being scanned, the copy job is canceled.

When there is a job printing or on standby, canceling job screen appears. The current print job is temporarily interrupted.

Select the job you wish to cancel > [Cancel] > [Yes]

NOTE

If "Reserve Next Priority" is set to Off, the Copying screen appears in the touch panel. In such a case, selecting the [Stop] key or [Cancel] will cancel the printing job in progress.

➔ [Reserve Next Priority \(page 452\)](#)

Basic Scanning (Sending)

This machine can send a scanned image as an attachment of an E-mail message or to a PC linked to the network. In order to do this, it is necessary to register the sender and destination (recipient) address on the network.

A network environment which enables the machine to connect to a mail server is required in order to send E-mail. It is recommended that a Local Area Network (LAN) be used to assist with transmission speed and security issues.

Follow the steps below for basic sending. The following four options are available.

- Send as E-mail (E-mail Addr Entry): Sends a scanned original image as an E-mail attachment.

➔ [Sending Document via E-mail \(page 248\)](#)

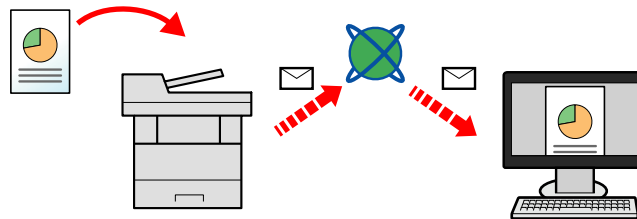

- Send to Folder (SMB): Stores a scanned original image in a shared folder of any PC.

➔ [Sending Document to Desired Shared Folder on a Computer \(Scan to PC\) \(page 250\)](#)

- Send to Folder (FTP): Stores a scanned original image in a folder of an FTP server.

➔ [Sending Document to Folder on an FTP Server \(Scan to FTP\) \(page 253\)](#)

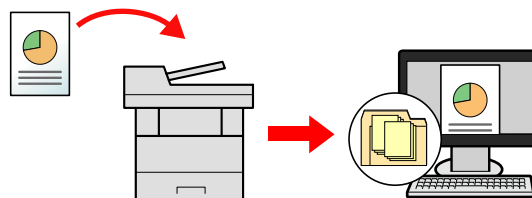

- Image Data Scanning with TWAIN / WIA: Scan the document using a TWAIN or WIA compatible application program.

➔ [Scanning using TWAIN or WIA \(page 256\)](#)

NOTE

- Different sending options can be specified in combination.

➔ [Sending to different types of destinations \(Multi sending\) \(page 263\)](#)

- The fax function can be used for sending.

The fax function can be used on products equipped with fax capability.

➔ **FAX Operation Guide**

Sending Document via E-mail

NOTE

- When transmitting using wireless LAN, select the interface dedicated to the send function in advance.
 - ➔ [Primary Network \(Client\) \(page 500\)](#)
- Before sending the scanned document with an E-mail, configure the SMTP and E-mail settings using the Command Center RX.
 - ➔ [SMTP and E-mail Settings \(page 125\)](#)

1 [Home] key > [Send]

2 Place the original.

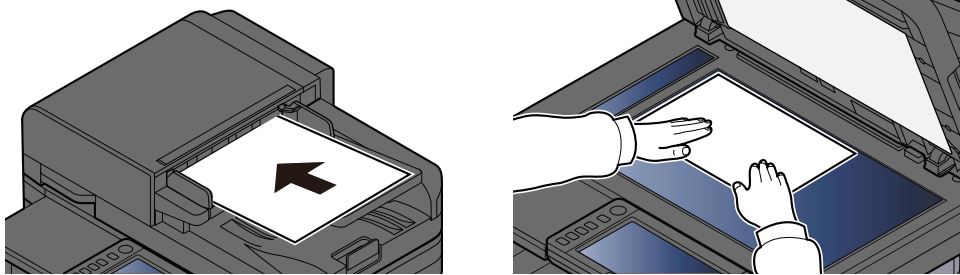

➔ [Loading Originals \(page 225\)](#)

3 In the destination screen for sending, select [Enter destination] > [Email]

4 Enter destination E-mail address > [OK]

Up to 256 characters can be entered.

➔ [Character Entry Method \(page 748\)](#)

When selecting On for "Entry Check for New Dest.", the re-entering screen for the destination information appears.

➔ [Re-enter new recipient information. \(page 274\)](#)

To enter multiple destinations, select [Next Destination] and enter the next destination. Up to 100 E-mail addresses can be specified.

You can register the entered E-mail address in the Address Book by selecting [Add to Address Book]. You can also replace the information for a previously registered destination.

Destinations can be changed later.

➔ [Checking and Editing Destinations \(page 272\)](#)

NOTE

- If "Broadcast" is set to [Prohibit], multiple destinations cannot be entered.
 - ➔ [Broadcast \(page 455\)](#)

5 Configure the settings.

Select the Global Navigation to display other functions.

➔ [Send \(page 306\)](#)

IMPORTANT

- [Email Encrypted TX] or [Digital Signature to Email] is displayed when S/MIME is configured from Command Center RX.
 - ➔ **Command Center RX User Guide**
 - When using [Email Encrypted TX] and [Digital Signature to Email], specify the Email addresses which have encryption certificate, from the address book. Cannot be set from the directly-entered address.
-

6 Press the [Start] key.

NOTE

When selecting On for "Destination Check before Send", the confirmation screen appears.

➔ [Confirmation Screen of Destinations \(page 273\)](#)

7 Press the [Start] key.

NOTE

A confirmation prompt is displayed on the screen if more than one destination is specified. Confirm and select [Yes]. Sending starts.

Sending Document to Desired Shared Folder on a Computer (Scan to PC)

You can store the scanned document into the desired shared folder on a computer.

NOTE

- When transmitting using wireless LAN, select the interface dedicated to the send function in advance.
 - ➔ [Primary Network \(Client\) \(page 500\)](#)
- Before sending the scanned document to the shared folder on your computer, you must configure the following settings:
 - Make a note of the computer name and full computer name
 - ➔ [Making a Note of the Computer Name and Full Computer Name \(page 156\)](#)
 - Make a note of the user name and domain name
 - ➔ [Making a Note of the User Name and Domain Name \(page 157\)](#)
 - Create a shared folder and make a note of the shared folder name
 - ➔ [Creating a Shared Folder, Making a Note of a Shared Folder \(page 158\)](#)
 - Configure the Windows firewall
 - ➔ [Configuring Windows Firewall \(page 163\)](#)

1 [Home] key > [Send]

2 Place the original

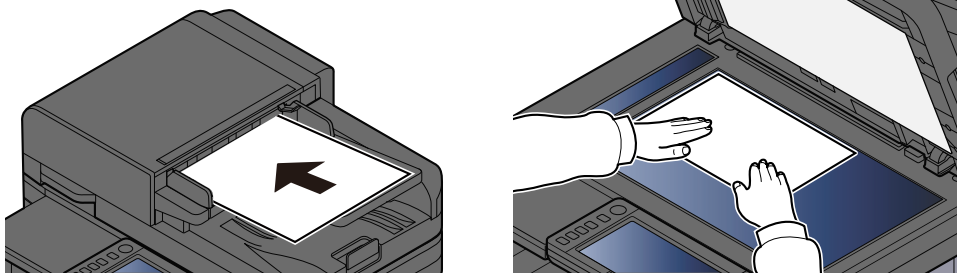

➔ [Loading Originals \(page 225\)](#)

3 In the destination screen for sending, select [Enter destination] > [SMB]

4 Enter the destination information

To directly specify the SMB folder, select [Folder Path Entry] and enter each item.

NOTE

When selecting On for "Entry Check for New Dest.", the re-entering screen for the destination information appears.

➔ [Re-enter new recipient information. \(page 274\)](#)

The table below explains the items to be entered.

Setting	Detail
Host Name	<p>Computer name. Enter "Host Name" or "IP Address". To enter the IPv6 address, enclose the address in brackets []. Limited character count: 256 characters or less Example: [2001:db8:a0b:12f0::10] (Example: [2001:db8:a0b:12f0::10])</p>
Port	<p>Port number If the port number is not specified, the default port number is 445.</p>
Folder Path	<p>Share name Limited character count: 260 characters or less For example: scannerdata If saving in a folder in the shared folder: share name\folder name in shared folder</p>
Login User Name	<ul style="list-style-type: none"> • If the computer name and domain name are the same User Name For example: james.smith. • If the computer name and domain name are different Domain name\User name For example: abcdnet\james.smith <p>Limited character count: 64 characters or less When transmitting using the optional network interface (IB-37, IB-38 or IB-51), only alphanumeric characters are allowed. Also, if the computer name and domain name are different because "\" is not available, use @ to enter the user name in the following format: User name@Domain name (Example: james.smith@abcdnet)</p>
Login Password	<p>Logon password. Limited character count: 128 characters or less Upper case and lower case letters are distinguished (case sensitive).</p>

You can search for a folder on a PC on the network. Select [Search Folder from Network] or [Search Folder by Host Name]. Select the folder from the Search Results list.



NOTE

- If you selected [Search Folder from Network], you can search all PCs on the network for a destination.
- If you selected [Search Folder by Host Name], you can search for a destination from among PCs that are connected to the network by entering "Domain/Workgroup Name"/"Host Name".
- A maximum of 500 addresses can be displayed. Select the host name (PC name) that you want to specify in the screen that appears, and select [OK]. The login user name and login password entry screen appears.
- After you enter the login user name and login password of the destination PC, the shared folders appear. Select the folder that you want to specify and select [OK]. The address of the selected shared folder is set.

5 Check the information.

- 1 Check the information.

Change the settings as required.

- 2 Select [Connection Test] to check the connection.

"Connected." appears when connection to the destination is correctly established. If "Cannot connect." appears, review the entry.

To enter multiple destinations, select [Next Destination] and enter the next destination.

You can register the entered information in the Address Book by selecting [Add to Address Book].



NOTE

- If "Broadcast" is set to [Prohibit], multiple destinations cannot be entered.
-

6 Select [OK].

Destinations can be changed later.

7 Configure the functions.

Select the Global Navigation to display other functions.

8 Press the [Start] key.



NOTE

When selecting On for "Destination Check before Send", the confirmation screen appears.

➔ [Confirmation Screen of Destinations \(page 273\)](#)

9 Press the [Start] key.



NOTE

A confirmation prompt is displayed on the screen if more than one destination is specified. Confirm and select [Yes]. Sending starts.

Sending Document to Folder on an FTP Server (Scan to FTP)

 **NOTE**

- When transmitting using wireless LAN, select the interface dedicated to the send function in advance.
 → [Primary Network \(Client\) \(page 500\)](#)
- Before sending a document, configure the FTP Client (Transmission).
 → [Protocol Settings \(page 488\)](#)

1 [Home] key > [Send]

2 Load paper.

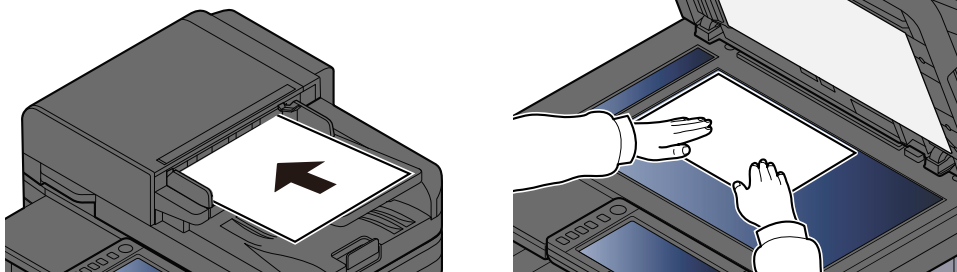

→ [Loading Originals \(page 225\)](#)

3 In the destination screen for sending, select [Enter destination] > [FTP]

4 Enter the destination details.

→ [Character Entry Method \(page 748\)](#)

 **NOTE**

When selecting On for "Entry Check for New Dest.", the re-entering screen for the destination information appears.

→ [Re-enter new recipient information. \(page 274\)](#)

The table below explains the items to be entered.

Setting	Detail
Host Name	Host name or IP address of FTP server To enter the IPv6 address, enclose the address in brackets []. Limited character count: 64 characters or less Example: [2001:db8:a0b:12f0::1]
Port	Port number If the port number is not specified, the default port number is 21.

Setting	Detail
Folder Path	Path for the file to be stored Limited character count: 128 characters or less For example: User\ScanData If no path is entered, the file is stored in the home directory. When the FTP server is based on Linux/UNIX, the path including the sub-folder is combined by the slash "/" not using the back-slash.
Login User Name	FTP server login user name Limited character count: 64 characters or less
Login Password	FTP server login password Limited character count: 64 characters or less Upper case and lower case letters are distinguished (case sensitive).

5 Check the information.

1 Check the information.

Change the settings as required.

2 Select [Connection Test] to check the connection.

"Connected." appears when connection to the destination is correctly established. If "Cannot connect." appears, review the entry.

To enter multiple destinations, select [Next Destination] and enter the next destination.

You can register the entered information in the Address Book by selecting [Add to Address Book].



NOTE

- If "Broadcast" is set to [Prohibit], multiple destinations cannot be entered.

➔ [Broadcast \(page 455\)](#)

6 Select [OK].

Destinations can be changed later.

➔ [Checking and Editing Destinations \(page 272\)](#)

7 Configure the functions.

Select the Global Navigation to display other functions.

➔ [Send \(page 306\)](#)

8 Press the [Start] key.



NOTE

When selecting On for "Destination Check before Send", the confirmation screen appears.

➔ [Confirmation Screen of Destinations \(page 273\)](#)

9 Press the [Start] key.



NOTE

A confirmation prompt is displayed on the screen if more than one destination is specified. Confirm and select [Yes]. Sending starts.

Scanning using TWAIN or WIA

This subsection explains how to scan an original using TWAIN. The WIA driver is used in the same way.

NOTE

- When transmitting using wireless LAN, select the interface dedicated to the send function in advance.
 - ➔ [Primary Network \(Client\) \(page 500\)](#)
 - Before sending a document, confirm that TWAIN/WIA driver is installed on a computer and the settings are configured.
 - ➔ [Setting TWAIN Driver \(page 112\)](#)
 - ➔ [Setting WIA Driver \(page 114\)](#)
-

1 Display the screen.

- 1 Activate the TWAIN compatible application software.
 - 2 Select the machine using the application and display the dialog box.
-

NOTE

For selecting the machine, see the Operation Guide or Help for each application software.

2 Configure the settings.

Select scanning settings in the dialog box that opens.

NOTE

For the settings, refer to Help in the dialog box.

3 Place the original.

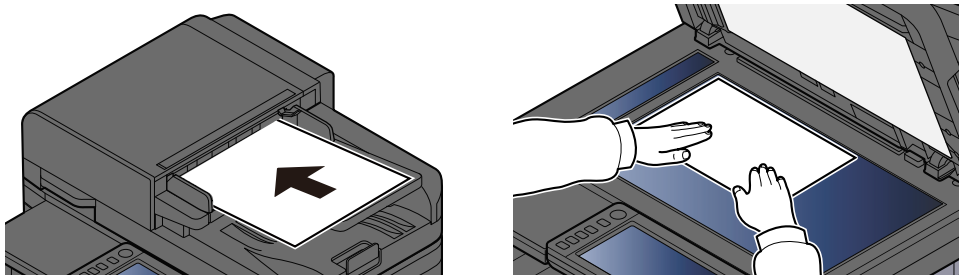

➔ [Loading Originals \(page 225\)](#)

4 Scan the originals.

Click the [Scan] button. The document data is scanned.

Scanning Document stored in a Custom Box

Follow the steps as below for scanning a document stored in a custom box using the TWAIN driver. When transmitting using wireless LAN, select the interface dedicated to the send function in advance.

NOTE

- When transmitting using wireless LAN, select the interface dedicated to the send function in advance.
➔ [Primary Network \(Client\) \(page 500\)](#)
 - Before sending a document, confirm that TWAIN driver is installed on a computer and the settings are configured.
➔ [Setting TWAIN Driver \(page 112\)](#)
 - To load a document saved in the Custom Box, select the model name with (Box) from "Model" on the TWAIN driver configuration screen.
-

1 Display the screen.

- 1 Activate the TWAIN compatible application software.
 - 2 Select the machine using the application and display the dialog box.
-

NOTE

For selecting the machine, see the Operation Guide or Help for each application software.

2 Display lists of documents.

- 1 Select a custom box stored a document.
If a password has been set for the box, the password entry screen appears. Enter the password and click the [OK] button. When you select a box, the document files in the Custom Box appear in "Document List".
 - 2 Set how to display the document data. Click the [Setting] button to select each item.
-

NOTE

For the settings, refer to Help in the dialog box.

- 3 Click the [OK] button.

3 Scan the originals.

- 1 Select the document data to be scanned from "Document List".
Enter the document data name in the "Search (Name)" to find the data having the same document data name or the document data name with the same beginning.
Click the [Detail] button to display the selected document data. When the document data includes multiple pages, select the checkbox beside the pages you want to scan. The selected pages will be scanned.



NOTE

In this case, the scanned page or the selected document data will not be deleted from the Custom Box.

- 2 Click the [Acquire] button.
The document data is scanned.

Useful Sending Method

You can specify the following useful scanning (sending) methods.

WSD Scan

Saves images of originals scanned on this machine as files on a WSD-compatible computer.

➔ [Executing WSD scan \(page 261\)](#)

Scanning using File Management Utility

Scans a document using the settings of File Management Utility and saves the image data and scanning information on a specified server or in a specified folder.

➔ [Scanning with FMU Connection \(page 262\)](#)

Scanning using the fax server

You can send a scanned document via a fax server.

➔ [Using a Fax Server to Send \(Fax Server Send\) \(page 266\)](#)

Sending to different types of destinations (Multi sending)

Sends to different types of destination (E-mail addresses, folders, etc.) in a single operation.

➔ [Sending to different types of destinations \(Multi sending\) \(page 263\)](#)

Send to Me (Email)

Sends to the E-mail address of the logged in user when user login is enabled.

➔ [Sending Documents to E-mail Address of Logged in User \(to myself\) \(page 265\)](#)

WSD Scan

WSD Scan saves images of originals scanned on this machine as files on a WSD-compatible computer.

NOTE

- To use WSD Scan, confirm that the computer used for WSD scanning and the machine is network-connected, and "Sending Job - WSD Scan" is set to [On] in the network settings.
 - ➔ [WSD Scan \(page 461\)](#)
 - For information on operating the computer, refer to the computer's help or the operation guide of your software.
 - When transmitting using wireless LAN, select the interface dedicated to the send function in advance.
 - ➔ [Primary Network \(Client\) \(page 500\)](#)
-

Install the Driver (for Windows 10)

1 Right-click the [Start] button in Windows and select [Control Panel] → [Devices and Printers]

2 Install the driver.

Click [Add Device]. Select the icon that displays the machine model name, and click [Next].

When the machine model icon is displayed as a "printer" on the "Devices and Printers" screen, installation is complete.

Install the Driver (for Windows 11)

1 Click the [Start] button → [All apps] → [Windows Tools] → [Control Panel] → [Devices and Printers]

2 Install the driver.

Click [Add Device]. Select the icon that displays the machine model name, and click [Next].

When the machine model icon is displayed as a "printer" on the "Devices and Printers" screen, installation is complete.

Install the Driver (for Windows 8.1, Microsoft Windows Server 2012)

1 Click [Settings] in the Charms Bar on Desktop → [Control Panel] → [Devices and Printers]

2 Install the driver.

Click [Add Device]. Select the icon that displays the machine model name, and click [Next].

When the machine model icon is displayed as a "printer" on the "Devices and Printers" screen, installation is complete.

Executing WSD scan

WSD Scan saves images of originals scanned on this machine as files on a WSD-compatible computer.

NOTE

- When transmitting using wireless LAN, select the interface dedicated to the send function in advance.
 - ➔ [Primary Network \(Client\) \(page 500\)](#)
- To use WSD Scan, confirm that the computer used for WSD scanning and the machine are network-connected, and "WSD Scan" is set to [On] in the network settings.
 - ➔ [WSD Scan \(page 461\)](#)
- For information on operating the computer, refer to the computer's help or the operation guide of your software.

1 [Home] key > [Send]

2 Place the original.

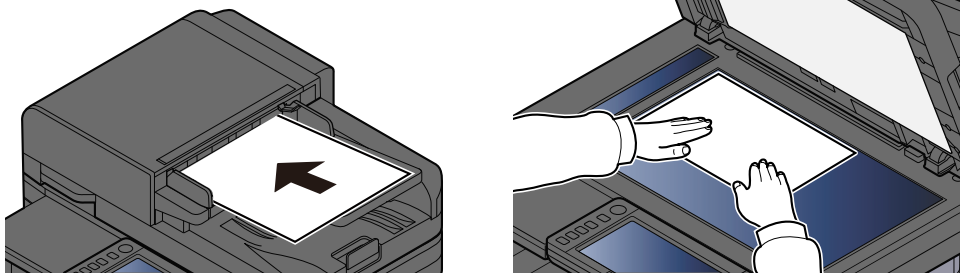

➔ [Loading Originals \(page 225\)](#)

3 In the destination screen for sending, select [Enter destination] > [WSD Scan]

4 Scan the originals.

- For procedure using this machine, refer to step 8 in step 5.
- For procedure from your computer, refer to step 10 in step 9.

5 (Procedure using this machine) [From Operation Panel] > [Next >]

6 Select the destination computer > [OK]

Select [Reload] to reload the computer list.

You can view information on the selected computer by selecting  (information icon).

7 Set the type of original, file format, etc., as desired.

8 Press the [Start] key.

Sending begins and the software installed on the computer is activated.

9 (Procedure from your computer) [From Computer] > [Start]

10 Use the software installed on the computer to send the images.

Scanning with FMU Connection

"FMU Connection" is installed on the machine as a standard application. FMU Connection can be used to scan an original according to the settings configured with "File Management Utility" (downloaded from Download Center (<https://kyocera.info/>)), and save the image data and scanning information on a specified server or folder. Unlike regular transmission functions, this application lets you use metadata such as the scan date and time and the data format.

1 Configure the settings.

The first time you use FMU Connection, you must start it up in System Menu.

→ [Activating Applications \(page 239\)](#)

To use FMU Connection, you must install File Management Utility on your computer and configure the multifunction machine to be used, scanning conditions, and the file save location. For installation of File Management Utility, refer to the following:

→ [Installing Software \(page 96\)](#)



NOTE

For information on using File Management Utility, refer to the following:

→ [File Management Utility User Guide](#)

2 Make sure that File Management Utility is running on the computer (or server) on which File Management Utility is installed.

3 Place the original.

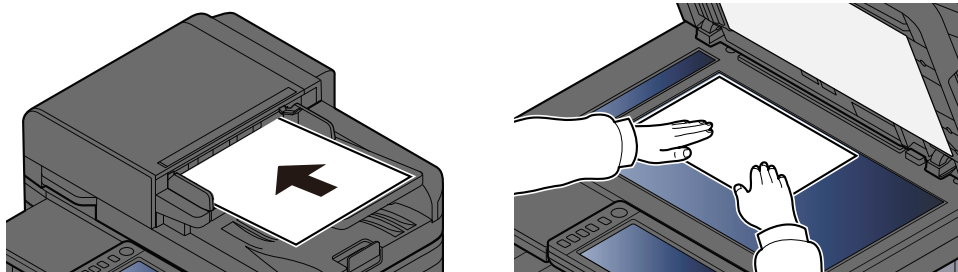

4 Select [FMU Connection].

FMU Connection will start up.

5 Follow the on-screen instructions to enter the necessary information and select [Next].

6 When the scan settings screen appears, select each item and configure the necessary settings.

The features that can be set depend on File Management Utility.

7 Press the [Start] key.

Scanning starts.

Sending to different types of destinations (Multi sending)

You can specify destinations combining E-mail addresses, folders (SMB or FTP), and fax numbers. This is referred to as Multi Sending. This is useful for sending to different types of destination (E-mail addresses, folders, etc.) in a single operation.

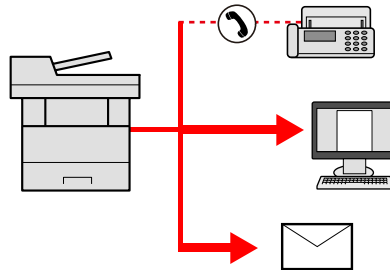

No. of broadcast items: Up to 50

However, number of items are restricted for the following sending options.

- E-mail and fax: Up to 100 in total
- Folders (SMB, FTP): Total of 5 SMB and FTP

Also, depending on the settings, you can send and print at the same time.

Procedures are the same as used in specifying the destinations of respective types. Continue to enter E-mail address or folder path so that they appear in the destination list. Press the [Start] key to start transmission to all destinations at one time.

NOTE

- If the destinations include a fax, the images sent to all destinations will be black and white.
- If [Broadcast] is set to [Prohibit], multiple destinations cannot be entered.

➔ [Broadcast \(page 455\)](#)

Sending to different types of destinations

1 [Home] key > [Send]

2 Place the original.

3 Specify the recipient.

4 Configure the settings.

Select the Global Navigation to display other functions.

➔ [Send \(page 306\)](#)

5 Press the [Start] key.

 **NOTE**

When selecting On for "Destination Check before Send", the confirmation screen appears.

➔ [Confirmation Screen of Destinations \(page 273\)](#)

6 Press the [Start] key.

 **NOTE**

A confirmation prompt is displayed on the screen. Confirm and select [Yes].

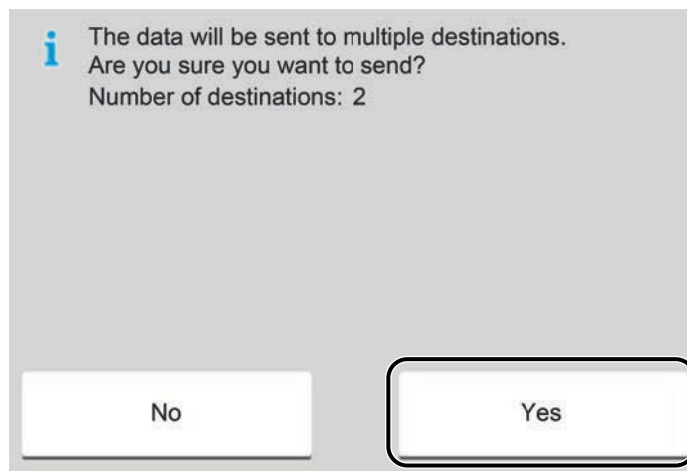

Sending starts.

Sending Documents to E-mail Address of Logged in User (to myself)

Sends to the E-mail address of the logged in user when user login is enabled.

1 Configure the settings.

Before using this function, the following are necessary.

- The function icon must be displayed in the home screen.
 - ➔ [Editing the Home Screen \(page 61\)](#)
- An E-mail address must be set in user login for the user who logs in.
 - ➔ [Adding a User \(Local User List\) \(page 524\)](#)

2 Select the [Home] key

3 Select [Send to Me (Email)].



NOTE

When this function is used, functions other than transmission cannot be used.

Using a Fax Server to Send (Fax Server Send)

You can send a scanned document via a fax server.

NOTE

- A fax server is required to use this function. For information about the fax server, contact the applicable administrator.
 - FAX server settings must be configured to send a FAX. For details, refer to the following:
 - ➔ **Command Center RX User Guide**
 - ➔ [Fax Server \(page 499\)](#)
-

1 [Home] key > [Send]

2 Place the original.

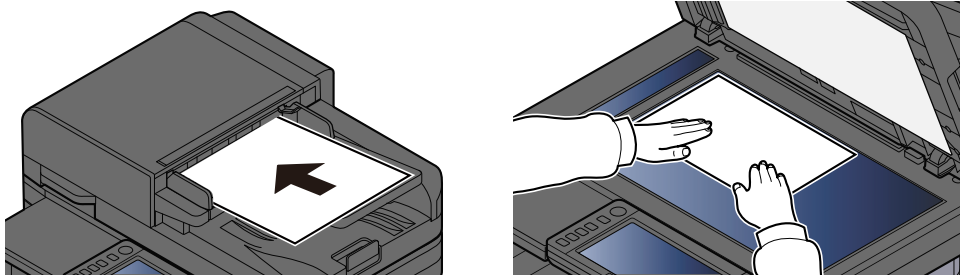

➔ [Loading Originals \(page 225\)](#)

3 Display the screen.

In the destination screen for sending, select [+] > [Fax Server].

4 Enter the recipient information.

- 1 Select [Fax No. Entry].
- 2 Enter the fax number > [OK]

NOTE

- Use the numeric keys to enter a number.
 - When selecting On for "Entry Check for New Dest.", the re-entering screen for the destination information appears.
 - ➔ [Re-enter new recipient information. \(page 274\)](#)
-

Destinations can be changed later.

➔ [Checking and Editing Destinations \(page 272\)](#)

 **NOTE**

- When selecting the information from the Address Book, select [Address Book], and specify the destination > [OK].
➔ [Choosing from the Address Book \(page 270\)](#)
 - When selecting the information from an External Address Book, select [External Address Book], and specify the destination > [OK].
For details on the External Address Book, refer to the following:
➔ **Command Center RX User Guide**
-

5 Configure the functions.

Select the Global Navigation to display other functions.

➔ [Send \(page 306\)](#)

6 Press the [Start] key.

 **NOTE**

When selecting On for "Destination Check before Send", the confirmation screen appears.

➔ [Confirmation Screen of Destinations \(page 273\)](#)

7 Press the [Start] key.

 **NOTE**

A confirmation prompt is displayed on the screen if more than one destination is specified. Confirm and select [Yes]. Sending starts.

Canceling Sending Jobs

1 Select the [Stop] key with the send screen displayed.

2 Cancel a job.

When there is a job is being scanned, Job Cancel appears.

When there is a job sending or on standby, Canceling job screen appears. Select the job you wish to cancel > [Cancel] > [Yes]



NOTE

Selecting the [Stop] key will not temporarily stop a job that you have already started sending.

Handling Destination

This section explains how to select and confirm the destination.

Specifying Destination

Select the destination using either of the following methods except entering address directly:

- Choosing from the Address Book

➔ [Choosing from the Address Book \(page 270\)](#)

- Choosing from the External Address Book

For details on the External Address Book, refer to the following:

➔ **Command Center RX User Guide**

- Choosing from One Touch key

➔ [Choosing from One Touch Key \(page 271\)](#)

- Choosing from the Search (No.)

➔ [Choosing from the Search \(No.\) \(page 272\)](#)

- Choosing from the FAX

The fax function can be used on products equipped with fax capability.

➔ **FAX Operation Guide**



NOTE

- You can set the machine up so that the address book screen appears when you select the [Send] key.

➔ [Default Screen \(page 455\)](#)

- If you are using the products equipped with the fax function, you can specify the fax destination. Enter the other party number using the numeric keypad.
-

Choosing from the Address Book

For more information about how to register destinations in the Address Book, refer to the following:

➔ [Registering Destinations in the Address Book \(page 173\)](#)

1 In the Destination screen for sending, select [Address Book] >

NOTE

For details on the External Address Book, refer to the following:

➔ [Command Center RX User Guide](#)

2 Select the destinations.

Select the checkbox to select the desired destination from the list. Multiple destinations can be selected. The selected destinations are indicated by a checkmark in the check box. To use an address book on the LDAP server, select [Select] > [Address Book] > [External Address Book].

Select [Name] or [No.] to sort the destination list.

NOTE

- To deselect, select the checkbox again and remove the checkmark.
- If "Broadcast" is set to [Prohibit], multiple destinations cannot be selected. This also applies to a group in which multiple destinations are registered.

➔ [Broadcast \(page 455\)](#)

Destinations registered in the Address Book can be searched.

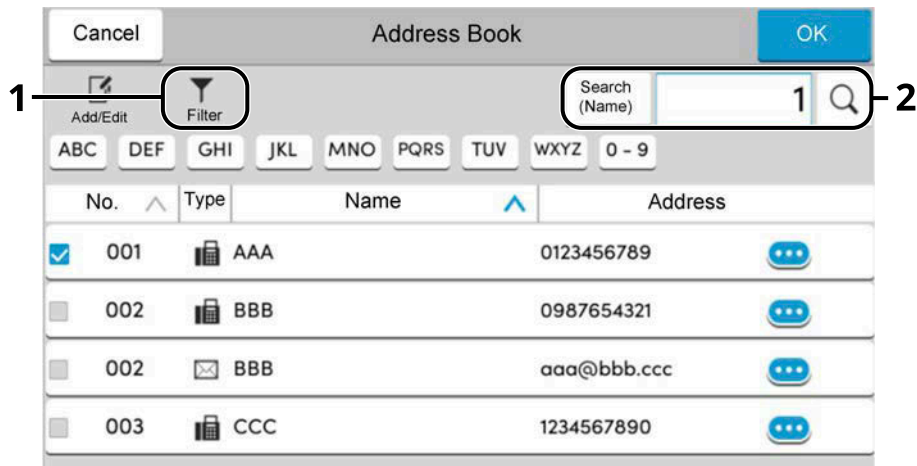

1 [Filter]

Advanced search by type of registered destination (Email, Folder, Fax or Group). (Fax: Only when the optional FAX Kit is installed.) You can set up this function so that destination types are selected when the address book is displayed.

➔ [Narrow Down \(page 462\)](#)

2 [Search(No.)] or [Search(Name)]

Search by registered address number or name. Select either [Search(No.)] or [Search(Name)] to switch between [Search(No.)] and [Search(Name)].

3 Accept the destination > [OK]

Destinations can be changed later.

➔ [Checking and Editing Destinations \(page 272\)](#)



NOTE

You can set the default sort setting of the address for the address book.

➔ [Sort \(page 462\)](#)

Choosing from One Touch Key

1 In the destination screen for sending, select the One Touch Keys where the destination is registered.

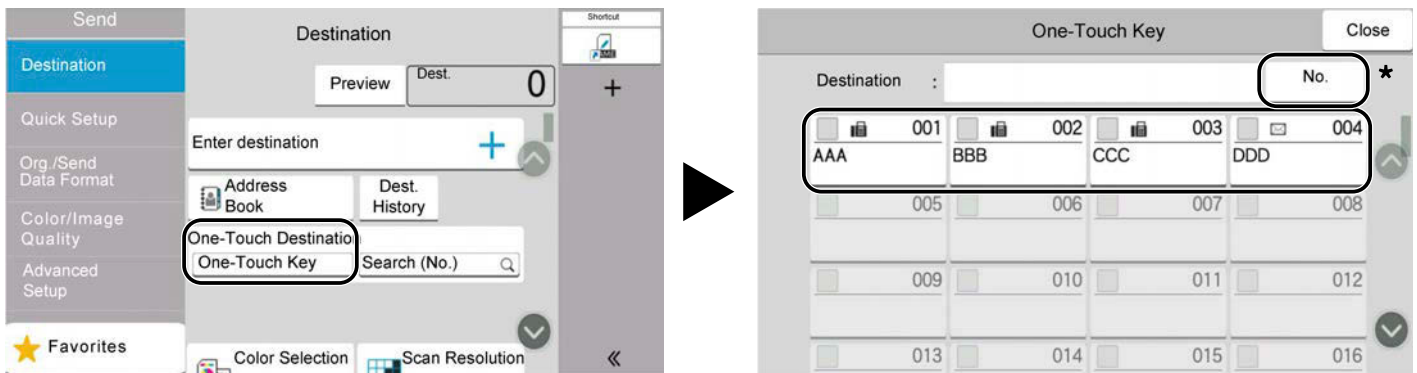

NOTE

- If the One Touch Key for the desired destination is hidden on the touch panel, select or . Displays One Touch Keys that are hidden. This procedure assumes that One Touch Keys have already been registered. For more information on adding One Touch keys, refer to the following:

➔ [Adding a Destination on One Touch Key \(page 185\)](#)

- The No. key has the same function as [Search (No.)] displayed on the touch panel. Use to directly enter a number with the numeric keys, such as specifying a transmission address using a one-touch key number, or calling up a stored program using the program number. For information on one-touch key numbers, refer to the following:

➔ [Choosing from the Search \(No.\) \(page 272\)](#)

Choosing from the Search (No.)

Access the destination by specifying the 4-digit (0001 to 1000) One Touch Key number.

- 1 In the destination screen for sending, select [Search (No.)] to display the numeric entry screen. Select the number entry field and enter the One-Touch Key number with the numeric keypad.

NOTE

If you entered the One Touch Key in 1 to 3-digit, select [OK].

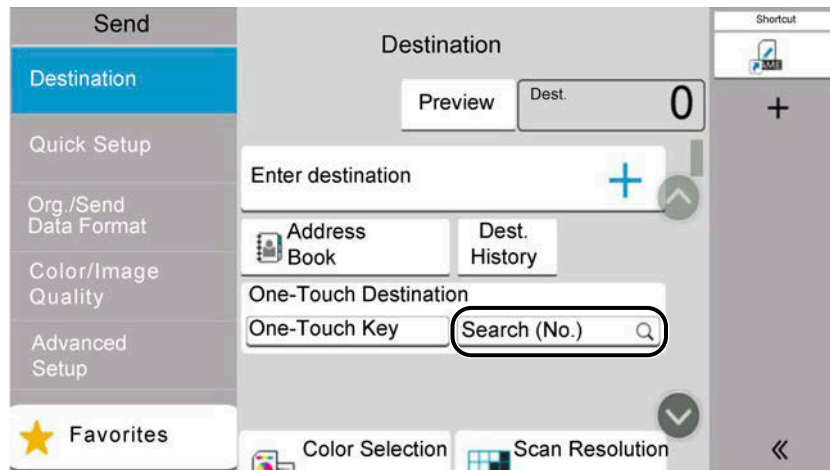

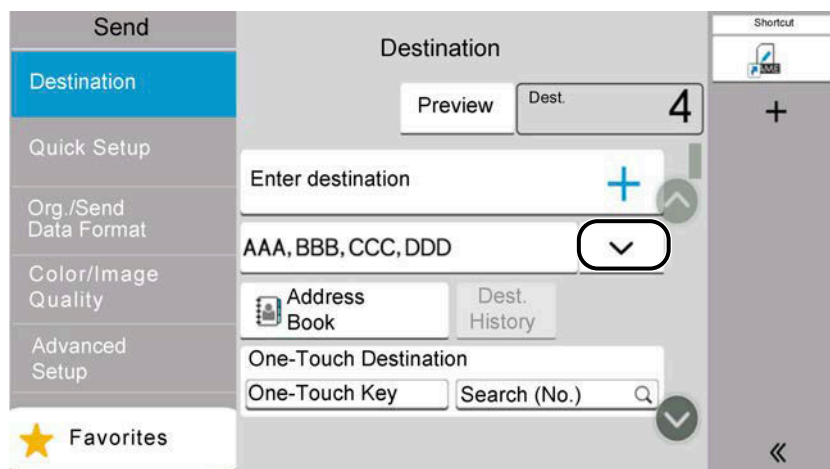

Checking and Editing Destinations

- 1 **Display the screen.**
Specify the destination.
→ [Specifying Destination \(page 269\)](#)
- 2 **Check and edit the destination.**



Select ∨ to display a destination list.

- Select  (information icon) to check the destination.
- Select  (edit icon) to modify the destination.
- Select  (delete icon) to remove the destination from the list.



NOTE

- When selecting On for "Entry Check for New Dest.", the confirmation screen appears. Enter the same destination again, and select [OK].
 - ➔ [Entry Check for New Dest. \(page 455\)](#)
- If "Destination Check before Send" is set to On, the confirmation screen appears when the [Start] key is pressed.
 - ➔ [Destination Check before Send \(page 455\)](#)
 - ➔ [Confirmation Screen of Destinations \(page 273\)](#)

Confirmation Screen of Destinations

When selecting On for "Destination Check before Send", the confirmation screen of destinations appears after pressing the [Start] key.

➔ [Destination Check before Send \(page 455\)](#)

1 Move the screen to the bottom and confirm all destinations.

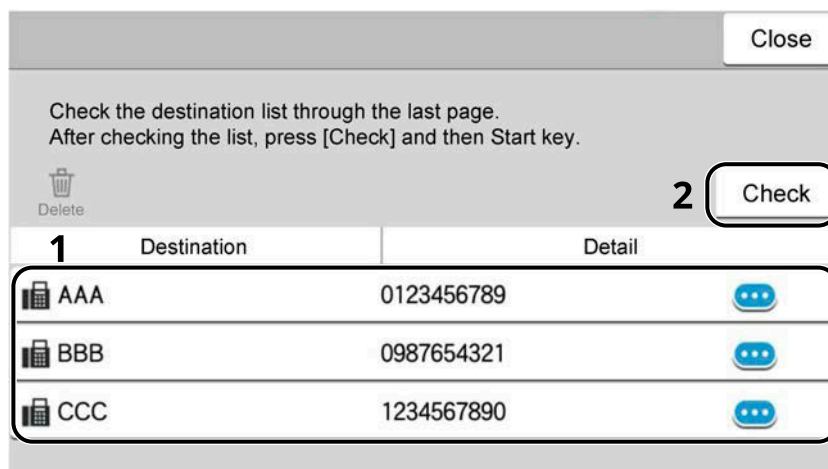

Selecting  (information icon) shows the detailed information of the destination.

To delete the destination, select the destination you want to delete > [Delete] > [Delete]

To add the destination, select [Close] and then return to the destination screen.

2 Select [Check].



NOTE

Be sure to confirm all destination by displaying them on the touch panel. You cannot select [Check] unless you have confirmed all destination.

Re-enter new recipient information.

When selecting On for "Entry Check for New Dest.", the re-entering screen for the destination information appears.

➔ [Entry Check for New Dest. \(page 455\)](#)

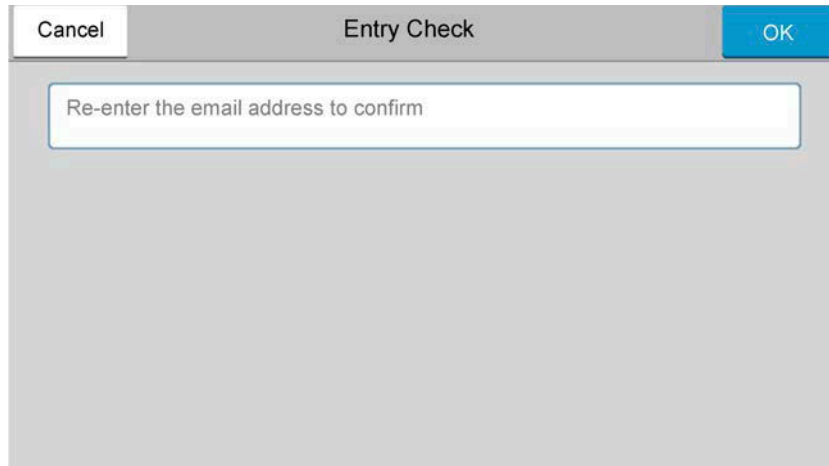

Enter the same destination information again, and select [OK].

Recall

"Recall" is a function allowing you to send the last entered destination once again. To send to the same destination again, select [Recall] to call the destination to the destination list.

1 Select [Recall].

The destination you sent is displayed on the destination list.

NOTE

When the last sending included FAX, folders and E-mail destinations, they are also displayed. If necessary, add or delete the destination.

2 Press the [Start] key.

Sending starts.

NOTE

- If "Destination Check before Send" is set to On, the destination confirmation screen appears when the [Start] key is pressed.
 - ➔ [Confirmation Screen of Destinations \(page 273\)](#)
 - Recall information is canceled in the following conditions.
 - When you turn the power off
 - When you send a next image (new recall information is registered)
 - When you log out
-

How to use the FAX Function

On products with a FAX function, it is possible to use the FAX function. The fax function can be used on products equipped with fax capability. For details, refer to the following:

➔ **FAX Operation Guide**

Using Document Boxes

Document Box is a function for saving print data from a computer and sharing it with multiple users. The following types of document boxes are available:

- Custom Box
- Job Box
- USB Drive Box
- Fax Memory RX Box (only for fax-compatible models)
- Subaddress Communication Box (only for fax-compatible models)
- Polling Box (only for fax-compatible models)

What is Custom Box?

Custom Box is a component box which you can create within the Document Box and store data for later retrieval. You can create or delete a Custom Box.

The following operations are possible:

- Creating a new Custom Box
- Printing Document in a Custom Box
- Saving scanned documents to a Custom Box
- Sending Documents in a Custom Box
- Editing Documents in a Custom Box
- Deleting Documents in Custom Box

NOTE

- An optional SSD is required to use a Custom Box.
- The operation on Custom Box can also be performed from Command Center RX.
➔ [Command Center RX User Guide](#)

What is Job Box?

Job Box is a generic name for the "Private Print/Stored Job Box", "Quick Copy/Proof and Hold Box", and "PIN Print Box".

These Job Boxes cannot be created or deleted by a user.

NOTE

- You can set up the machine so that temporary documents in job boxes are automatically deleted.
➔ [Deletion of Job Retention \(page 471\)](#)
 - For details on operating the "Private Print/Job Hold Box", "Quick Copy/Proof and Hold Box", or "PIN Print Box", refer to the following:
➔ [Printing Data Saved in the Printer \(page 207\)](#)
-

What is USB Drive Box?

A USB drive can be connected to the USB memory slot on the machine to print a saved file. You can print data directly from the USB drive without a PC.

Image files scanned using this machine can also be saved to USB drive in the PDF, TIFF, JPEG, XPS, OpenXPS, high compression PDF, Word, Excel or PowerPoint format (Scan to USB).



NOTE

Word, Excel and PowerPoint will be saved in a Microsoft Office 2007 or later file format.

What is a Fax Memory RX Box/Subaddress Box/Polling Box?

Fax Box store the fax data. The fax function can be used on products equipped with fax capability. For details, refer to the following:

➔ **FAX Operation Guide**

Basic Operation for Document Box

This section explains basic operations for document boxes, using examples where tasks are carried out with custom boxes.

NOTE

In the following explanation, it is assumed that user login administration is enabled. For details on User Logon privileges, refer to the following:

➔ [Editing Custom Box \(page 285\)](#)

Box List

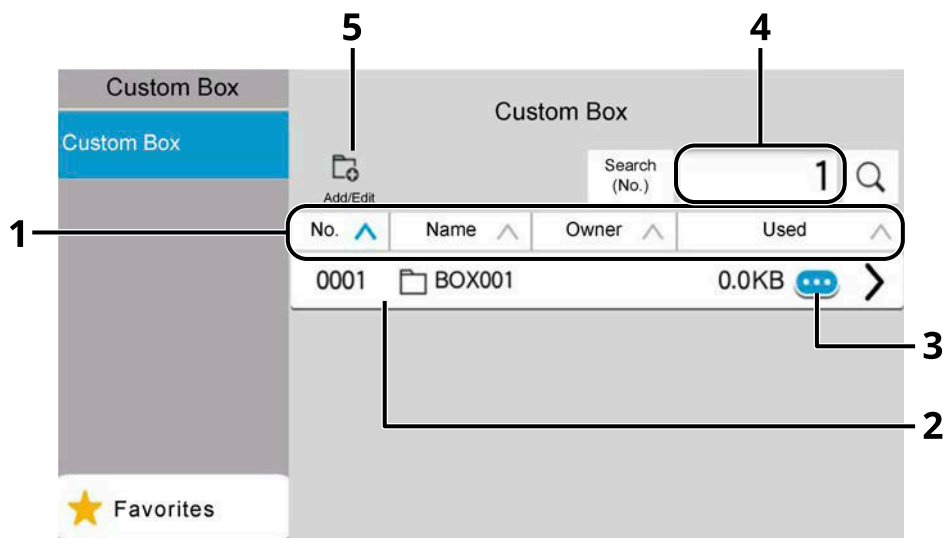

- 1 Sorts the box number, box name, owner name and size of data saved in the box in ascending/ descending order.
- 2 This is a custom box. Select it to open it.
- 3 Displays the details for the selected box.
- 4 A box can be searched for by Box No. or Box Name. Select either [Search(No.)] or [Search(Name)] to switch between [Search(No.)] and [Search(Name)].
- 5 Registers new boxes and checks, modifies or deletes box information.

Document List

The document list is a list of the documents stored in the custom box. Documents can be listed either by name or as thumbnails. The list can be used as shown below.

List

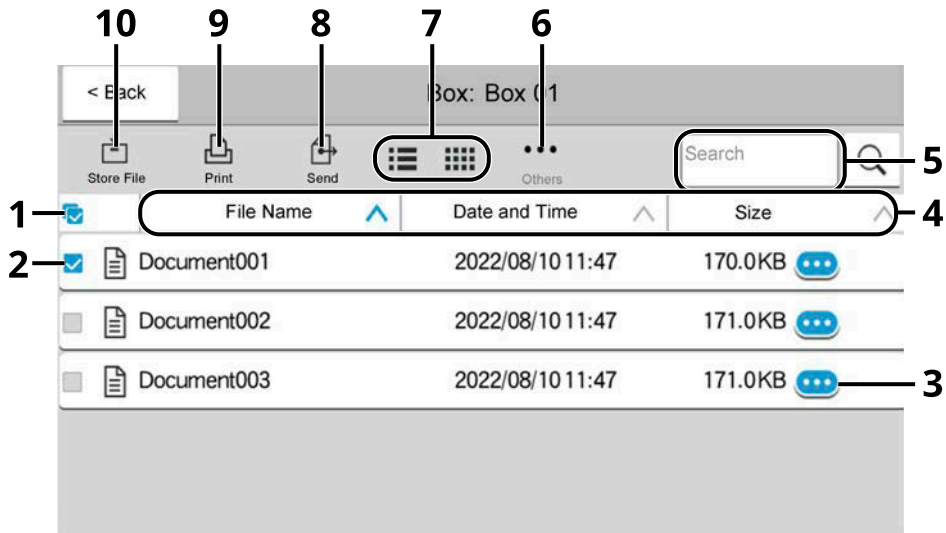

Thumbnail

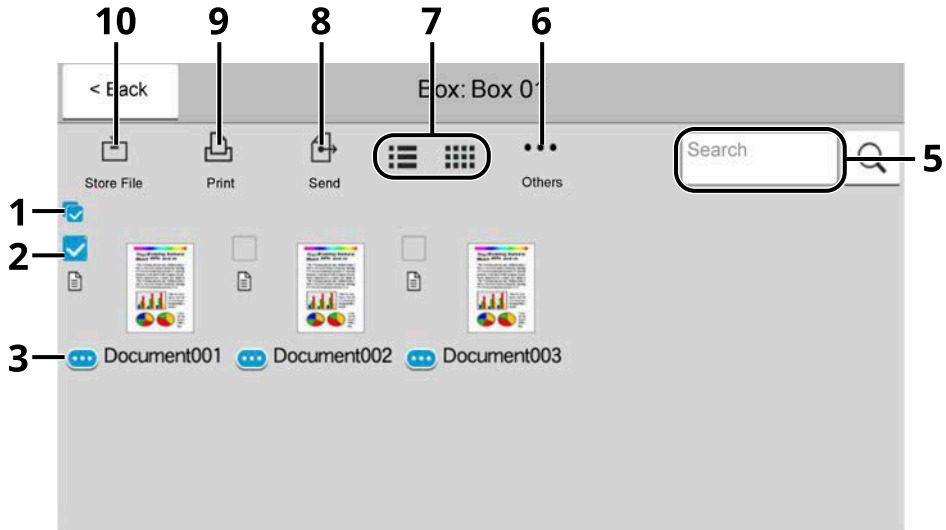

- 1 Select/deselect more than one document at a time.
- 2 Selecting documents by checking checkboxes.
- 3 Display the details for the selected document.
- 4 Sorts the file name, date and time and size of data in ascending/descending order.
- 5 A document can be searched for by Name.
- 6 The menu for document operations will be displayed.
- 7 Switches between list display and thumbnail display.

- 8 Sends the selected documents.
 - 9 Prints the selected documents.
 - 10 Saves the document in the open box.
-

 **NOTE**

You can select multiple documents by pressing the respective document checkboxes. However, note that you cannot select multiple documents when you are sending documents.

Viewing Box Details

- 1** Select  (information icon) for the box whose details you wish to check in the box list screen.
-

 **NOTE**

If a custom box is protected by a password, enter the correct password.

- 2** Check the box details.

- 3** Select [Close].

The display returns to the default Document Box screen.

Editing Box Details

- 1** Select [Add/Edit] in the box list screen.

- 2** Select the box whose details you wish to edit and select [Edit].
-

 **NOTE**

If a Custom Box is protected by a password, enter the correct password.

- 3** Edit the box details.

Enter new details.

- 4** If you have changed the details, select [OK] and then select [OK] in the confirmation screen.

If you do not change the details, select [Cancel].

- 5** Select [Close].

The display returns to the default Document Box screen.

Previewing Documents/Checking Document Details

- 1 Select a document to preview and then select [Others] > [Preview].
- 2 Preview the document or check the document details.

The operations available in the preview screen are shown below.

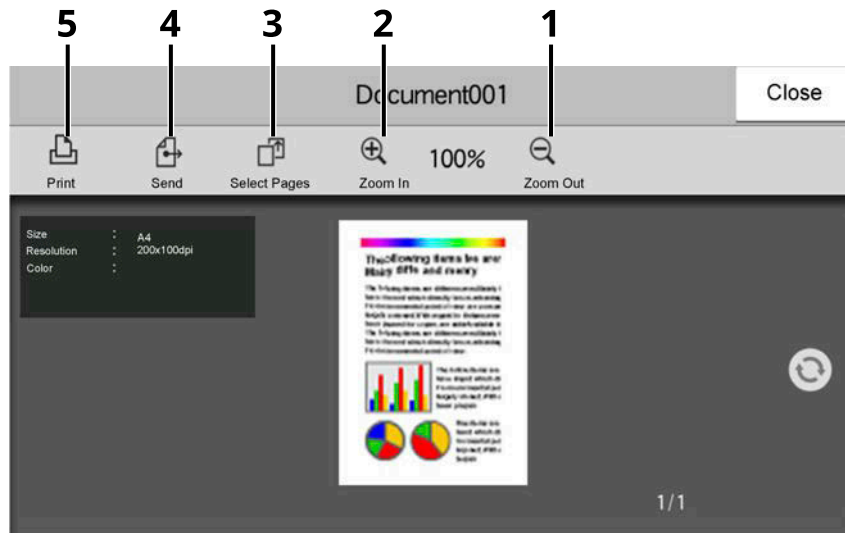

- 1 Zoom out.
- 2 Zoom in.
- 3 Select to select any page of the open document and print, send or copy to USB Drive.
➔ [Selecting a Page \(page 282\)](#)
- 4 Sends the selected documents.
- 5 Prints the selected documents.



NOTE

The preview display can be controlled by moving your finger(s) on the touch panel.

➔ [Using the Preview Screen \(page 71\)](#)

- 3 Once you have completed the check, select [Close].

Selecting a Page

When printing, sending, or copying a document within a Custom Box, you can specify any pages at will.

- 1 Select [Others] > [Page Select.] in the document list screen of the Custom Box, or [Page Select.] in the Preview screen.**

The page selection screen is displayed.

- 2 Select the pages you want to work with, and select [Print], [Send], or [Copy to USB].**

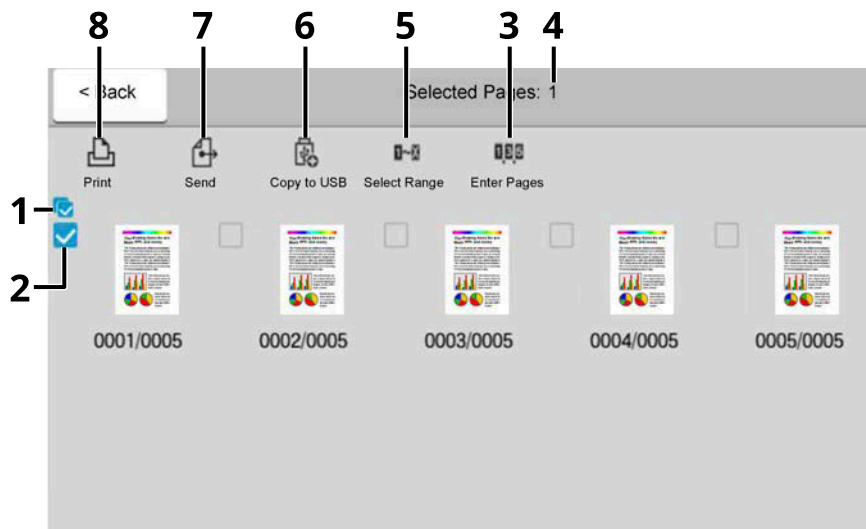

- 1 Selecting/deselecting more than one document at a time.
- 2 Selecting documents by checking checkboxes.
- 3 Use a "," (comma) to separate numbers when specifying pages that are not consecutive.
- 4 Specify a continuous page range.
- 5 Displaying the number of pages selected.
- 6 Selected pages can be copied to USB drive.
- 7 Selected pages can be sent.
- 8 Selected pages can be printed.

➔ [Printing Document in a Custom Box \(page 288\)](#)

➔ [Sending Documents in a Custom Box \(page 290\)](#)

➔ [Moving Documents in Custom Box \(page 292\)](#)

Creating a New Custom Box

 **NOTE**

- An optional SSD is required to use the Custom box.
 - If the user authentication screen appears, log in with a user who has the privilege to configure this setting. If you do not know your login user name or password, please contact your administrator.
 - If user login administration is enabled, log in with administrator privileges to perform the following operations. They cannot be performed with user privileges.
 - Creating a box
 - Deleting a box of which owner is another user.
-

1 Display the screen.

[Home] key > [Custom Box] > [Add/Edit]

2 Register the Custom Box.

1 [Add] > Add information on each item

The following items can be set.

Box Name

Enter a box name consisting of up to 32 characters.

➔ [Character Entry Method \(page 748\)](#)

Box No.

Enter the box number by selecting [+], [-], or numeric keys. The box number can be from 0001 to 1000. A Custom Box should have a unique number. If you enter 0000, the smallest number available will be automatically assigned.

[Owner]

Set the owner of the box. Select the owner from the user list that appears.

Displayed when the user login administration is enabled.

Permission

Select whether to share the box.

Not displayed when [Owner] is set to [No Owner].

[Box Password]

User access to the box can be restricted by specifying a password to protect the box. Entering a password is not mandatory. Enter the same password of up to 16 characters in both "Box Password" and "Confirmation". This can be set if [Shared] is selected in "Permission".

Usage Restriction

The usage for a box can be restricted. To enable a capacity restriction enter a value for the storage capacity of the Custom Box in megabytes by selecting [+], [-], or numeric keys. The upper limit varies depending on the number of custom boxes that have been created, you can enter a limit between 1 and 30,000 (MB).

Auto File Deletion

Automatically deletes stored documents after a set period of time. Select On to enable automatic deletion and then use [+], [-], or numeric keys to enter the number of days for which documents are stored. You can enter any number between 1 and 31 (day(s)). To disable automatic file deletion, select Off.

Free Space

Displays the free space on the box.

Overwrite Setting

Specifies whether or not old stored documents are overwritten when new documents are stored. To overwrite old documents, select [Permit]. To retain old documents, select [Prohibit].

Delete after Printed

Automatically delete a document from the box once printing is complete. To delete the document, select On. To retain the document, select Off.

- 2 Select [OK].

The Custom Box is created.

Editing Custom Box

1 Display the screen.

[Home] key > [Custom Box] > [Add/Edit]

2 Edit the custom box.

1 Select the box > [Edit] > Enter the information for each item > [OK]



NOTE

- When you have logged in as a user, you can only edit a box whose owner is set to that user.
 - When you have logged in as administrator, you can edit all boxes.
-

When user login administration is enabled, the settings that can be changed varies depending on the privileges of the logged in user.

The settings that can be changed when the privilege is "Administrator" are as follows.

- Box Name
- Box No.
- Owner
- Permission
- Usage Restriction
- Auto File Deletion
- Free Space
- Overwrite Setting
- Delete after Printed

The settings that can be changed when the privilege is "User" are as follows.

- Box Name
- Box Password
- Usage Restriction
- Auto File Deletion
- Overwrite Setting
- Delete after Printed

For details on each item, refer to the following:

➔ [Creating a New Custom Box \(page 283\)](#)

3 [OK] > [Close]

The display returns to the default Document Box screen.

Delete the box.

1 Display the screen.

[Home] key > [Custom Box] > [Add/Edit]

2 Delete the box.

1 Select the box > [Delete] > [Delete]



NOTE

- When you have logged in as a user, you can only delete a box whose owner is set to that user.
 - When you have logged in as administrator, you can edit all boxes.
-

Storing Documents to a Custom Box

Custom box stores the print data which is sent from a PC. For the operation of the printing from the PC, refer to the following:

➔ **Printer Driver User Guide**

Printing Document in a Custom Box

1 Display the screen.

- 1 [Home] key > [Custom Box]
- 2 Select the box containing the document you want to print.

NOTE

If a custom box is protected by a password, enter the correct password.

2 Print.

- 1 Select the document in the list that you want to print by selecting the checkbox.
The document is marked with a checkmark.

NOTE

To deselect, select the checkbox again and remove the checkmark.

- 2 Select [Print].
- 3 Set the paper selection, duplex printing, etc., as desired.

For the features that can be set, refer to the following:

- ➔ [Custom Box \(Store File\) \(page 311\)](#)
- ➔ [Custom Box \(Print\) \(page 313\)](#)
- ➔ [Custom Box \(Send\) \(page 314\)](#)

NOTE

Select [Favorites] when registering or calling up favorites.

- ➔ [Register Favorites \(Wizard Mode\) \(page 233\)](#)
- ➔ [Recalling Favorites \(Program Mode\) \(page 235\)](#)

If a document stored from a computer is selected, the print settings selection screen appears.

To use the settings used at the time of printing (when the document was saved), select [Print As Is]. Select [Start Print] to start printing.

If you need to change the print settings, select [Print after Change Settings (Use File Settings)] or [Print after Change Settings (Do Not Use File Settings)].

After a document saved in the machine is selected, [Use File Settings] key may appear in the setting screen for the feature to be used.

To use the settings saved with the document, select [Use File Settings].

If you need to change the print settings, select the desired feature.

- 4 Press the [Start] key.
Printing of the selected document begins.

Saving scanned documents to a Custom Box

1 Display the screen.

[Home] key > [Custom Box]

2 Place the original.

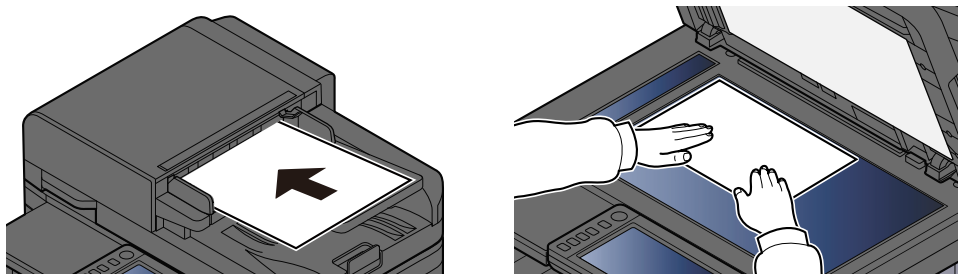

3 Store the document.

1 Select the box > [Store File]

2 Set the type of original, file format, etc., as desired.

For the features that can be set, refer to the following:

➔ [Custom Box \(Store File\) \(page 311\)](#)



NOTE

- Enter up to 32 characters as the file name.
- Select [Favorites] when registering or recalling favorites.

➔ [Register Favorites \(Wizard Mode\) \(page 233\)](#)

➔ [Recalling Favorites \(Program Mode\) \(page 235\)](#)

3 Press the [Start] key.

The original is scanned and the data is stored in the specified Custom Box.

Sending Documents in a Custom Box

 **NOTE**

When transmitting using wireless LAN, select the interface dedicated to the send function in advance.

➔ [Primary Network \(Client\) \(page 500\)](#)

1 Display the screen.

[Home] key > [Custom Box] > Select the box

 **NOTE**

If the Custom Box is protected by a password, enter the correct password.

2 Send the document.

- 1 Select the document you wish to send by checking the checkbox.

The document is marked with a checkmark.

 **NOTE**

- You cannot select and send multiple documents.
 - To deselect, select the checkbox again and remove the checkmark.
-

- 2 Select [Send].
-

 **NOTE**

Depending on the settings, the address book screen may appear.

- 3 Set the destination.

For more information on selecting destinations, refer to the following:

➔ [Specifying Destination \(page 269\)](#)

 **IMPORTANT**

Only when specifying the E-mail addresses which have encryption certificate from the address book, Email Encrypted TX and Digital Signature to Email can be used. When entering E-mail address from the operation panel, you can not use these functions.

- 4 Set the sending size, original image, etc., as desired.

For the features that can be set, refer to the following:

➔ [Custom Box \(Send\) \(page 314\)](#)



NOTE

Select [Favorites] when registering or recalling favorites.

➔ [Register Favorites \(Wizard Mode\) \(page 233\)](#)

➔ [Recalling Favorites \(Program Mode\) \(page 235\)](#)

5 Press the [Start] key.

Sending of the selected document begins.

Sending Documents to E-mail Address of Logged in User (to myself)

Sends to the E-mail address of the logged in user when user login is enabled.

1 Configure the settings.

Before using this function, the following are necessary.

- The function icon must be displayed in the home screen.
➔ [Editing the Home Screen \(page 61\)](#)
- An E-mail address must be set in user login for the user who logs in.
➔ [Adding a User \(Local User List\) \(page 524\)](#)

2 Select the [Home] key

3 Select [Send to Me (Email)].



NOTE

When this function is used, functions other than transmission cannot be used.

Moving Documents in Custom Box

1 Display the screen.

[Home] key > [Custom Box] > Select the box

 **NOTE**

If a custom box is protected by a password, enter the correct password.

2 Copy the documents.

1 Select the document in the list that you want to move by selecting the checkbox.

The document is marked with a checkmark.

 **NOTE**

To deselect, select the checkbox again and remove the checkmark.

2 [Others] > [Move/Copy] > [Move to Custom Box] > Select the destination > [Move] > [Move]

The selected document is moved.

 **NOTE**

If the custom box to which the document is to be moved is protected by a password, enter the correct password.

Copying Documents in Custom Box into Other Boxes

1 Display the screen.

[Home] key > [Custom Box] > Select the box

 **NOTE**

If the Custom Box is protected by a password, enter the correct password.

2 Copy the documents.

1 Select the document in the list that you want to copy by selecting the checkbox.

The document is marked with a checkmark.

 **NOTE**

To deselect, select the checkbox again and remove the checkmark.

2 [Others] > [Move/Copy] > [Copy to Custom Box] > Select copy destination > [Copy] > [Copy]

The selected document is copied.

 **NOTE**

If the custom box to which the document is to be moved is protected by a password, enter the correct password.

Copying Documents in Custom Box to USB Drive

1 Display the screen.

[Home] key > [Custom Box] > Select the box



NOTE

If a Custom Box is protected by a password, enter the correct password.

2 Copy the documents.

- 1 Select the document in the list that you want to copy by selecting the checkbox.

The document is marked with a checkmark.



NOTE

To deselect, select the checkbox again and remove the checkmark.

- 2 [Others] > [Move/Copy] > [Copy to USB Drive] > Select copy destination > [Next >] > Select function > [Copy] > [Copy]

The selected document is copied.

Joining Documents in Custom Box

You can join documents within a custom box into one file.

NOTE

You can only join a document to other documents in the same custom box. If necessary, move the documents to be joined beforehand.

1 Display the screen.

[Home] key > [Custom Box] > Select the box

NOTE

If a custom box is protected by a password, enter the correct password.

2 Join the document.

- 1 Select the documents in the list that you wish to join by selecting the checkbox.

The document is marked with a checkmark.

You can join up to 10 documents.

NOTE

To deselect, select the checkbox again and remove the checkmark.

- 2 Select [Others] > [Join].

- 3 Arrange the documents into the order in which they are to be joined.

Select the document you want to rearrange and select [Up] or [Down] to move it to the correct place in the sequence.

- 4 [Next >] > Enter the file name for the joined document
-

NOTE

Enter up to 64 characters as the file name.

- 5 [Join] > [Join]

The documents are joined.

NOTE

After joining, the original documents are left unchanged. Delete the documents if they are no longer needed.

Deleting Documents in Custom Box

1 Display the screen.

- 1 [Home] key > [Custom Box]
- 2 Select the box containing the document to delete.



NOTE

If a custom box is protected by a password, enter the correct password.

2 Delete the document.

- 1 Select the document in the list that you want to delete by selecting the checkbox.
The document is marked with a checkmark.



NOTE

- [Delete] is disabled until a document is selected.
 - To deselect, select the checkbox again and remove the checkmark.
-

- 2 [Others] > [Delete] > [Delete]

The document is deleted.

Using Removable USB Drive

Plugging USB drive directly into the machine enables you to quickly and easily print the files stored in the USB drive without having to use a computer.

The following file types can be printed:

- PDF file (Version 1.7 or older)
- TIFF file (TIFF V6/TTN2 format)
- JPEG file
- XPS file
- OpenXPS file
- Encrypted PDF file

In addition, you can store scanned image files in USB drive connected to the machine. The following file formats can be stored:

- PDF file
- TIFF file
- JPEG file
- XPS file
- OpenXPS file
- High-compression PDF file format
- Word file format
- Excel file format
- PowerPoint file format



NOTE

Word, Excel and PowerPoint will be saved in a Microsoft Office 2007 or later file format.

Printing Documents Stored in Removable USB Drive

 **NOTE**

- PDF files you wish to print should have an extension (.pdf).
 - Use USB drive properly formatted by this machine.
 - Plug the USB drive directly into the USB Memory Slot.
-

1 Plug the USB drive.

- 1 Plug the USB drive into the USB memory slot.

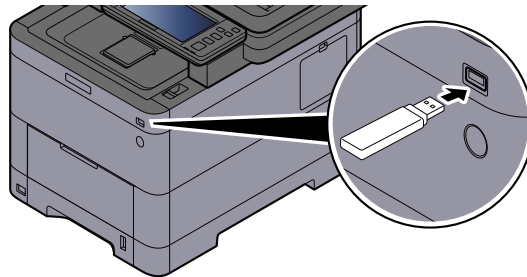

When the machine recognizes the USB drive, the message "USB Drive is recognized. Displaying files." appears.

- 2 Select [Continue].
Displays the USB drive operation screen.
-

 **NOTE**

If the message does not appear, select [USB Drive] on the Home screen.

2 Print the document.

- 1 Select the folder containing the file to be printed.
-

 **NOTE**

- 1,000 documents can be displayed.
 - To return to a higher level folder, select [Up].
-

- 2 Select the file to be printed > [Print]
- 3 Change the number of copies, duplex printing, etc. as desired.
For the features that can be set, refer to the following:
➔ [USB Drive \(Printing Documents\) \(page 319\)](#)



NOTE

After a document saved in the machine is selected, [Use File Settings] may appear in the setting screen for the feature to be used.

- To use the settings saved with the document, select [Use File Settings].
 - If you need to change the print settings, select the desired feature.
-

4 Press the [Start] key.

Printing of the selected file begins.

Saving Documents to USB Drive (Scan to USB)

You can store scanned documents to a removal USB drive.

NOTE

The maximum number of the storable files is 1,000.

1 Place the original.

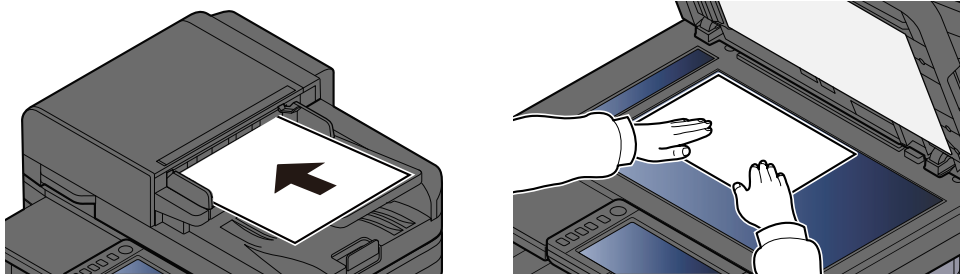

➔ [Loading Originals \(page 225\)](#)

2 Plug the USB Drive.

- 1 Plug the USB drive into the USB Memory Slot.

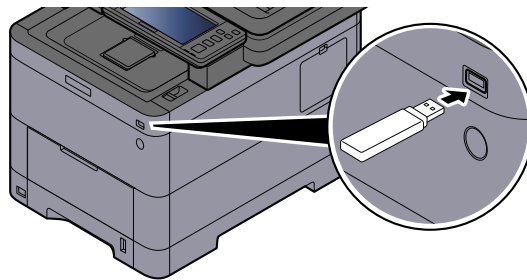

When the machine recognizes the USB drive, the message "USB Drive is recognized. Displaying files." appears.

- 2 Select [Continue].
Displays the USB Drive screen.

NOTE

If the message does not appear, select [USB Drive] on the Home screen.

3 Store the document.

- 1 Select the folder where the file will be stored.
- 2 Select [Store File].
- 3 Set the type of original, file format, etc., as desired.
For the features that can be set, refer to the following:

➔ [USB Drive \(Store File\) \(page 317\)](#)

- 4 Check the storing image.
- 5 Press the [Start] key.
The original is scanned and the data is stored in the USB drive.

Check the USB Drive Information

- 1 In the USB Drive screen, select [USB Info].
- 2 Once you confirm the information, select [Close].

Removing USB Drive

IMPORTANT

Be sure to follow the proper procedure to avoid damaging the data or USB drive.

- 1 **Display the screen.**
[Home] key > [USB Drive]
 - 2 **Select [Remove USB].**
When "USB Drive can be safely removed." is displayed, select [OK] then remove the USB drive.
-

NOTE

USB drive can also be removed via Device Information.

➔ [Device Information \(page 409\)](#)

Tapping the USB drive icon shown at the top of the touch panel and selecting [Remove USB] allows you to safely remove the USB drive.

➔ [Home screen \(page 59\)](#)

6 Using Various Functions

About Functions Available on the Machine

This machine provides the various functions available.

Copy

Each function is displayed in the Body when Global Navigation is selected.

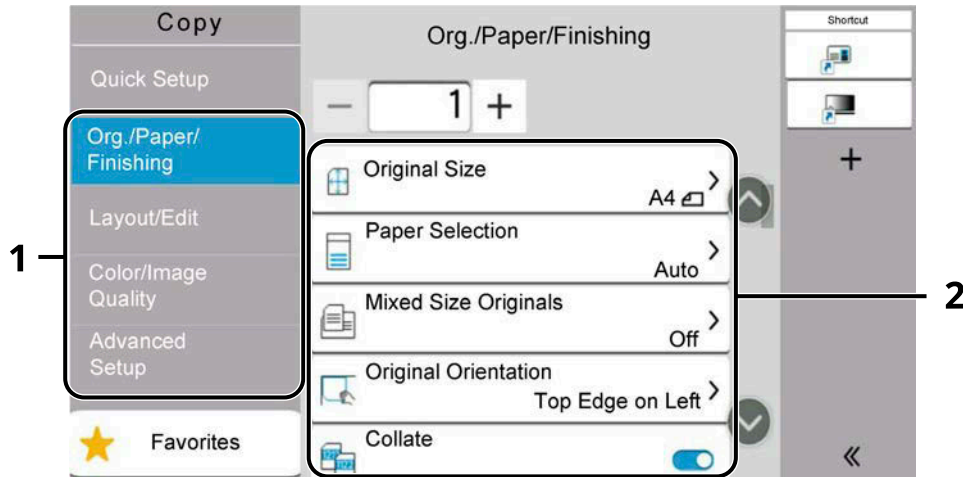

1 Global Navigation

2 Body

For details on each function, see the table below.

[Org./Paper/Finishing]

Configure the settings for originals, paper, and finishing such as collate.

Function	Description
[Original Size]	Specify the original size to be scanned. ➔ Original Size (page 321)
[Paper Selection]	Select the cassette or multipurpose tray that contains the required paper size. ➔ Paper Selection (page 323)
[Mixed Size Originals]	Scan the documents of different sizes that are set in the document processor all at once. ➔ Mixed Size Originals (page 325)
[Original Orientation]	Select the orientation of the original document top edge to scan correct direction. ➔ Original Orientation (page 328)
[Collate]	Prints the output by page or set. ➔ Collate (page 330)
[ID Card Copy]	Use this when you want to copy a driver's license or an insurance card. When you scan the front and back of the card, both sides will be combined and copied onto a single sheet. ➔ ID Card Copy (page 331)

[Layout/Edit]

Configure the settings for duplex printing.

Function	Description
[Zoom]	Adjust the zoom to reduce or enlarge the image. ➔ Copying (page 347)
[Combine]	Combines 2 or 4 original sheets into 1 printed page. ➔ Combine (page 349)
[Border Erase]	Erases the black border that forms around the image. ➔ Border Erase, Border Erase/Full Scan (page 352)
[Duplex]	Produces two-sided copies. You can also create single-sided copies from two-sided originals. ➔ Copying (page 358)

[Color/ImageQuality]

Configure the settings for density, quality of copies, and color balance.

Function	Description
[Density]	Adjust density. ➔ Density (page 332)
[Original Image]	Select original image type for best results. ➔ Original Image (page 333)
[Color Selection]	Select the color setting. ➔ Color Selection (page 337)
[EcoPrint]	EcoPrint saves toner when printing. ➔ EcoPrint (page 336)
[Color Balance]	Adjust the strength of cyan, magenta, yellow, and black. ➔ Color Balance (page 338)
[Hue Adjustment]	Adjust the color (hue) of images. ➔ Hue Adjustment (page 339)
[Sharpness]	Adjusts the sharpness of image outlines. ➔ Sharpness (page 341)
[Background Density Adj.]	Removes dark background from originals, such as newspapers. ➔ Background Density Adj. (page 342)
[Saturation]	Adjust the color saturation of the image. ➔ Saturation (page 343)
[Prevent Bleed-thru]	Hides background colors and image bleed-through when scanning thin originals. ➔ Prevent Bleed-thru (page 344)

Function	Description
[Contrast]	You can adjust the contrast between light and dark areas of the image. ➔ Contrast (page 345)
[Erase Colors]	Erases colors in the source document. ➔ Erase Colors (page 346)

[AdvancedSetup]

Allows you to configure settings such as continuous reading.

Function	Description
[Continuous Scan]	Scans a large number of originals in separate batches and then produces as one job. ➔ Continuous Scan (page 361)
[Job Finish Notice]	Sends E-mail notice when a job is complete. ➔ Job Finish Notice (page 362)
[File Name Entry]	Adds a file name. ➔ File Name Entry (page 363)
[Priority Override]	Suspends the current job and gives a new job top priority. ➔ Priority Override (page 364)
[Detect Multi-fed Originals]	When reading a document from the document processor, if the multiple feeding of documents is detected, then the reading stops automatically. This function is available only for TASKalfa MA4500ci. ➔ Detect Multi-fed Originals (page 366)
[Detect Folded Corner Orig.]	When scanning a document from the document processor, scanning is automatically stopped when a document with a folded corner is detected. ➔ Detect Folded Corner Orig. (page 367)
[Skip Blank Page]	When there are blank pages in a scanned document, this function skips the blank pages and prints only pages that are not blank. ➔ Skip Blank Page (page 368)
[Quiet Mode]	The operating sound of the machine can be suppressed. ➔ Quiet Mode (page 365)

Send

Each function is displayed in the Body when Global Navigation is selected.

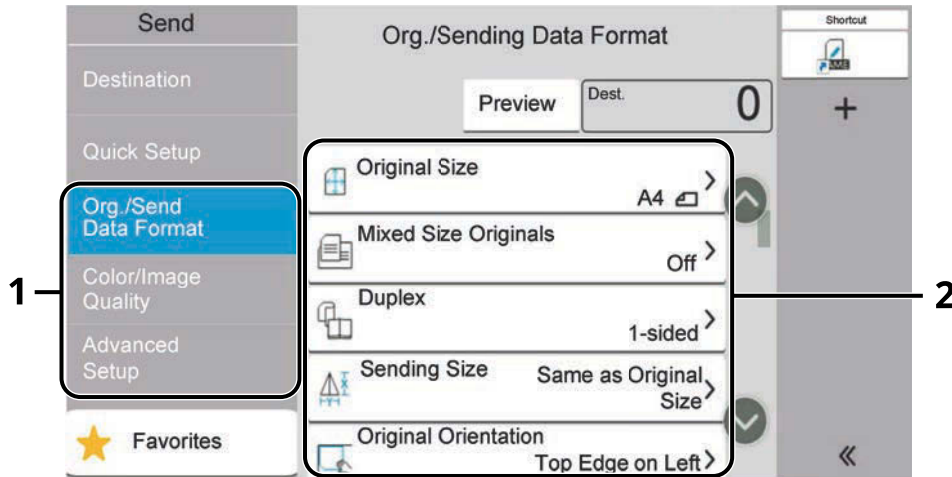

1 Global Navigation

2 Body

For details on each function, see the table below.

[Org./SendData Format]

Configure the settings for original type and file format.

Function	Description
[Original Size]	Specify the original size to be scanned. ➔ Original Size (page 321)
[Mixed Size Originals]	Scan the documents of different sizes that are set in the document processor all at once. ➔ Mixed Size Originals (page 325)
[Duplex]	Select the type and orientation of the binding based on the original. ➔ Duplex (page 369)
[Sending Size]	Select size of image to be sent. ➔ Sending Size (page 370)
[Original Orientation]	Select the orientation of the original document top edge to scan correct direction. ➔ Original Orientation (page 328)
[Long Original]	Reads long-sized original documents using a document processor. ➔ Long Original (page 372)
[File Format]	Specify the image file format. Image quality level can also be adjusted. ➔ File format (page 373)
[File Separation]	Creates a file for each scanned original data page and sends the files. ➔ File Separation (page 382)

[Color/ImageQuality]

Configure the settings for density, quality of copies, and color balance.

Function	Description
[Density]	Adjust density. ➔ Density (page 332)
[Original Image]	Select original image type for best results. ➔ Original Image (page 333)
[Scan Resolution]	Select fineness of scanning resolution. ➔ Scan Resolution, Resolution (page 383)
[Fax TX Resolution]	Select fineness of images when sending FAX. This item is displayed for fax-compatible machines. ➔ FAX Operation Guide
[Color Selection]	Select the color setting. ➔ Color Selection (page 337)
[Sharpness]	Adjusts the sharpness of image outlines. ➔ Sharpness (page 341)
[Clarify Text (Noise Removal)]	When scanning and sending a document in black and white, it eliminates background noise and improves the legibility of the text. ➔ Clarify Text (Noise Removal) (page 384)
[Background Density Adj.]	Removes dark background from originals, such as newspapers. ➔ Background Density Adj. (page 342)
[Prevent Bleed-thru]	Hides background colors and image bleed-through when scanning thin originals. ➔ Prevent Bleed-thru (page 344)
[Contrast]	You can adjust the contrast between light and dark areas of the image. ➔ Contrast (page 345)
[Erase Colors]	Erases colors in the source document. ➔ Erase Colors (page 346)

[AdvancedSetup]

Allows you to refrain from sending, send encrypted messages, and check file size, etc.

Function	Description
[Border Erase/Full Scan]	Erases the black border that forms around the image. ➔ Border Erase, Border Erase/Full Scan (page 352)
[Zoom]	Adjust the zoom to reduce or enlarge the image. ➔ Printing/Sending/Storing (page 348)

Function	Description
[Job Finish Notice]	Sends E-mail notice when a job is complete. ➔ Job Finish Notice (page 362)
[Fax Delayed Transmission]	Set a send time. This item is displayed for fax-compatible machines. ➔ FAX Operation Guide
[File Name Entry]	Adds a file name. ➔ File Name Entry (page 363)
[Continuous Scan]	Scans a large number of originals in separate batches and then produces as one job. ➔ Continuous Scan (page 361)
[Email Subject/Body]	Adds subject and body when sending a document. ➔ Email Subject/Body (page 385)
[Fax Direct Transmission]	Sends FAX directly without reading original data into memory. This item is displayed for fax-compatible machines. ➔ FAX Operation Guide
[Fax Polling RX]	Dial the destination and receive documents for Polling Transmission stored in the polling box. This item is displayed for fax-compatible machines. ➔ FAX Operation Guide
[FTP Encrypted TX]	Encrypts images when sending via FTP. ➔ FTP Encrypted TX (page 386)
[Email Encrypted TX]	Sends encrypted E-mail using the electronic certificate. ➔ Email Encrypted TX (page 387)
[Digital Signature to Email]	Add a digital signature to the email, using the electronic certificate. ➔ Digital Signature to Email (page 388)
[Fax TX Report]	Print a report of fax transmission results. This item is displayed for fax-compatible machines. ➔ FAX Operation Guide
[Detect Multi-fed Originals]	When reading a document from the document processor, if the multiple feeding of documents is detected, then the reading stops automatically. This function is available only for TASKalfa MA4500ci. ➔ Detect Multi-fed Originals (page 366)
[Detect Folded Corner Orig.]	When scanning a document from the document processor, scanning is automatically stopped when a document with a folded corner is detected. ➔ Detect Folded Corner Orig. (page 367)
[Skip Blank Page]	When there are blank pages in a scanned document, this function skips the blank pages and sends only pages that are not blank. ➔ Skip Blank Page (page 368)

Function	Description
[Quiet Mode]	The operating sound of the machine can be suppressed. → Quiet Mode (page 365)

Custom Box (Store File, Print, Send)

Each function is displayed in the Body 2 when Global Navigation 1 is selected.

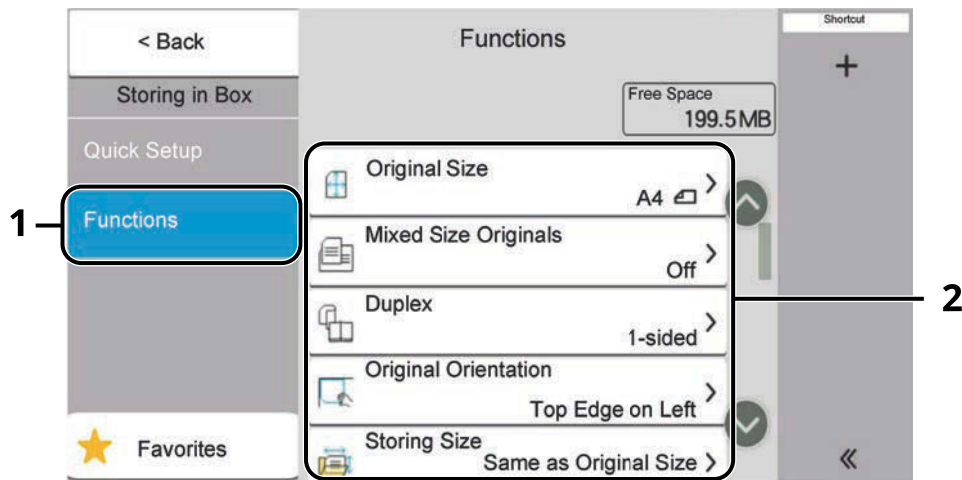

1 Global Navigation

2 Body

For details on each function, see below:

➔ [Custom Box \(Store File\) \(page 311\)](#)

➔ [Custom Box \(Print\) \(page 313\)](#)

➔ [Custom Box \(Send\) \(page 314\)](#)

Custom Box (Store File)

For details on each function, see the table below.

[Functions]

Configure the settings when storing the document in the Custom Box.

Function	Description
[Original Size]	Specify the original size to be scanned. ➔ Original Size (page 321)
[Mixed Size Originals]	Scan the documents of different sizes that are set in the document processor all at once. ➔ Mixed Size Originals (page 325)
[Duplex]	Select the type and orientation of the binding based on the original. ➔ Duplex (page 369)
[Original Orientation]	Select the orientation of the original document top edge to scan correct direction. ➔ Original Orientation (page 328)
[Storing Size]	Select size of image to be stored. ➔ Storing Size (page 391)
[Prevent Bleed-thru]	Hides background colors and image bleed-through when scanning thin originals. ➔ Prevent Bleed-thru (page 344)
[Density]	Adjust density. ➔ Density (page 332)
[Original Image]	Select original image type for best results. ➔ Original Image (page 333)
[Scan Resolution]	Select fineness of scanning resolution. ➔ Scan Resolution, Resolution (page 383)
[Color Selection]	Select the color setting. ➔ Color Selection (page 337)
[Erase Colors]	Erases colors in the source document. ➔ Erase Colors (page 346)
[Sharpness]	Adjusts the sharpness of image outlines. ➔ Sharpness (page 341)
[Background Density Adj.]	Removes dark background from originals, such as newspapers. ➔ Background Density Adj. (page 342)
[Zoom]	Adjust the zoom to reduce or enlarge the image. ➔ Printing/Sending/Storing (page 348)

Function	Description
[Continuous Scan]	Scans a large number of originals in separate batches and then produces as one job. ➔ Continuous Scan (page 361)
[Job Finish Notice]	Sends E-mail notice when a job is complete. ➔ Job Finish Notice (page 362)
[File Name Entry]	Adds a file name. ➔ File Name Entry (page 363)
[Detect Multi-fed Originals]	When reading a document from the document processor, if the multiple feeding of documents is detected, then the reading stops automatically. This function is available only for TASKalfa MA4500ci. ➔ Detect Multi-fed Originals (page 366)
[Detect Folded Corner Orig.]	When scanning a document from the document processor, scanning is automatically stopped when a document with a folded corner is detected. ➔ Detect Folded Corner Orig. (page 367)
[Skip Blank Page]	When there are blank pages in a scanned document, this function skips the blank pages and stores only pages that are not blank. ➔ Skip Blank Page (page 368)
[Quiet Mode]	The operating sound of the machine can be suppressed. ➔ Quiet Mode (page 365)
[Contrast]	You can adjust the contrast between light and dark areas of the image. ➔ Contrast (page 345)

Custom Box (Print)

For details on each function, see the table below.

[Functions]

Configure the settings for paper selection and duplex printing when printing from the Custom Box.

Function	Description
[Paper Selection]	Select the cassette or multipurpose tray that contains the required paper size. ➔ Paper Selection (page 323)
[Collate]	Prints the output by page or set. ➔ Collate (page 330)
[Duplex]	Print a document to 1-sided or 2-sided sheets. ➔ Duplex (During printing) (page 360)
[File Name Entry]	Adds a file name. ➔ File Name Entry (page 363)
[Job Finish Notice]	Sends E-mail notice when a job is complete. ➔ Job Finish Notice (page 362)
[EcoPrint]	EcoPrint saves toner when printing. ➔ EcoPrint (page 336)
[Priority Override]	Suspends the current job and gives a new job top priority. ➔ Priority Override (page 364)
[Delete after Printed]	Automatically delete a document from the box once printing is complete. ➔ Delete after Printed (page 390)
[Hue Adjustment]	Adjust the color (hue) of images. ➔ Hue Adjustment (page 339)
[Color Balance]	Adjust the strength of cyan, magenta, yellow, and black. ➔ Color Balance (page 338)
[Saturation]	Adjust the color saturation of the image. ➔ Saturation (page 343)

Custom Box (Send)

For details on each function, see the table below.

[Functions]

Configure the settings for file format and FAX transmission when sending from the Custom Box.

Function	Description
[File Format]	Specify the image file format. Image quality level can also be adjusted. ➔ File format (page 373)
[Fax TX Resolution]	Select fineness of images when sending FAX. This item is displayed for fax-compatible machines. ➔ FAX Operation Guide
[Job Finish Notice]	Sends E-mail notice when a job is complete. ➔ Job Finish Notice (page 362)
[Fax Delayed Transmission]	Set a send time. This item is displayed for fax-compatible machines. ➔ FAX Operation Guide
[File Name Entry]	Adds a file name. ➔ File Name Entry (page 363)
[Email Subject/Body]	Adds subject and body when sending a document. ➔ Email Subject/Body (page 385)
[Delete after Transmitted]	Automatically deletes a document from the box once transmission is complete. ➔ Delete after Transmitted (page 390)
[FTP Encrypted TX]	Encrypts images when sending via FTP. ➔ FTP Encrypted TX (page 386)
[Email Encrypted TX]	Sends encrypted E-mail using the electronic certificate. ➔ Email Encrypted TX (page 387)
[Digital Signature to Email]	Add a digital signature to the email, using the electronic certificate. ➔ Digital Signature to Email (page 388)
[File Separation]	Creates a file for each scanned original data page and sends the files. ➔ File Separation (page 382)
[Fax TX Report]	Print a report of fax transmission results. This item is displayed for fax-compatible machines. ➔ FAX Operation Guide

[Image Quality]

Allows you to configure the resolution settings.

Function	Description
[Resolution]	Select fineness of scanning resolution. ➔ Scan Resolution, Resolution (page 383)

USB Drive (Store File, Printing Documents)

Each function is displayed in the Body when Global Navigation is selected.

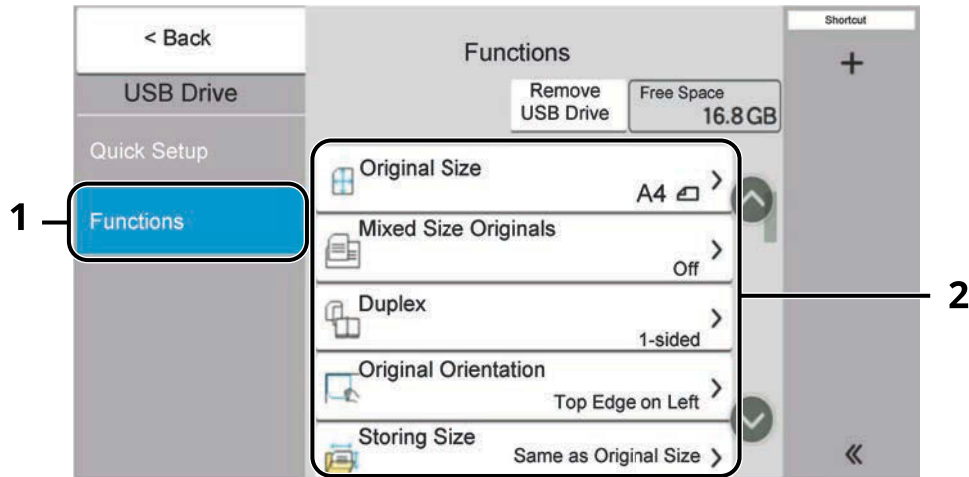

1 Global Navigation

2 Body

For details on each function, see below:

➔ [USB Drive \(Store File\) \(page 317\)](#)

➔ [USB Drive \(Printing Documents\) \(page 319\)](#)

USB Drive (Store File)

For details on each function, see the table below.

[Functions]

Configure the settings for color selection and document name when storing the document in the USB drive.

Function	Description
[Original Size]	Specify the original size to be scanned. ➔ Original Size (page 321)
[Mixed Size Originals]	Scan the documents of different sizes that are set in the document processor all at once. ➔ Mixed Size Originals (page 325)
[Duplex]	Select the type and orientation of the binding based on the original. ➔ Duplex (page 369)
[Original Orientation]	Select the orientation of the original document top edge to scan correct direction. ➔ Original Orientation (page 328)
[Storing Size]	Select size of image to be stored. ➔ Storing Size (page 391)
[Prevent Bleed-thru]	Hides background colors and image bleed-through when scanning thin originals. ➔ Prevent Bleed-thru (page 344)
[Density]	Adjust density. ➔ Density (page 332)
[Original Image]	Select original image type for best results. ➔ Original Image (page 333)
[Scan Resolution]	Select fineness of scanning resolution. ➔ Scan Resolution, Resolution (page 383)
[Color Selection]	Select the color setting. ➔ Color Selection (page 337)
[Erase Colors]	Erases colors in the source document. ➔ Erase Colors (page 346)
[Sharpness]	Adjusts the sharpness of image outlines. ➔ Sharpness (page 341)
[Clarify Text (Noise Removal)]	When scanning and sending a document in black and white, it eliminates background noise and improves the legibility of the text. ➔ Clarify Text (Noise Removal) (page 384)
[Background Density Adj.]	Removes dark background from originals, such as newspapers. ➔ Background Density Adj. (page 342)
[Zoom]	Adjust the zoom to reduce or enlarge the image. ➔ Printing/Sending/Storing (page 348)

Function	Description
[Border Erase/Full Scan]	Erases the black border that forms around the image. ➔ Border Erase, Border Erase/Full Scan (page 352)
[Continuous Scan]	Scans a large number of originals in separate batches and then produces as one job. ➔ Continuous Scan (page 361)
[File Name Entry]	Adds a file name. ➔ File Name Entry (page 363)
[File Format]	Specify the image file format. Image quality level can also be adjusted. ➔ File format (page 373)
[Job Finish Notice]	Sends E-mail notice when a job is complete. ➔ Job Finish Notice (page 362)
[File Separation]	Creates a file for each scanned original data page and sends the files. ➔ File Separation (page 382)
[Detect Multi-fed Originals]	When reading a document from the document processor, if the multiple feeding of documents is detected, then the reading stops automatically. This function is available only for TASKalfa MA4500ci. ➔ Detect Multi-fed Originals (page 366)
[Detect Folded Corner Orig.]	When scanning a document from the document processor, scanning is automatically stopped when a document with a folded corner is detected. ➔ Detect Folded Corner Orig. (page 367)
[Skip Blank Page]	When there are blank pages in a scanned document, this function skips the blank pages and stores only pages that are not blank. ➔ Skip Blank Page (page 368)
[Contrast]	You can adjust the contrast between light and dark areas of the image. ➔ Contrast (page 345)
[Quiet Mode]	The operating sound of the machine can be suppressed. ➔ Quiet Mode (page 365)
[Long Original]	Reads, sends, or saves long-sized original documents using a document processor. ➔ Long Original (page 372)

USB Drive (Printing Documents)

[Functions]

Configure the settings for paper selection and duplex printing when printing from the Custom Box.

Function	Description
[Paper Selection]	Select the cassette or multipurpose tray that contains the required paper size. ➔ Paper Selection (page 323)
[Collate]	Prints the output by page or set. ➔ Collate (page 330)
[Duplex]	Print a document to 1-sided or 2-sided sheets. ➔ Duplex (During printing) (page 360)
[File Name Entry]	Adds a file name. ➔ File Name Entry (page 363)
[Job Finish Notice]	Sends E-mail notice when a job is complete. ➔ Job Finish Notice (page 362)
[EcoPrint]	EcoPrint saves toner when printing. ➔ EcoPrint (page 336)
[Priority Override]	Suspends the current job and gives a new job top priority. ➔ Priority Override (page 364)
[Encrypted PDF Password]	Enter the preassigned password to print the PDF data. ➔ Encrypted PDF Password (page 393)
[JPEG/TIFF Print]	Select the image size when printing JPEG or TIFF files. ➔ JPEG/TIFF Print (page 394)
[XPS Fit to Page]	Reduces or enlarges the image size to fit to the selected paper size when printing XPS file. ➔ XPS Fit to Page (page 395)

[Color]

Configure the color mode settings.

Function	Description
[Color Selection]	Select the color setting. ➔ Color Selection (page 337)

Functions

On pages that explain a convenient function, the modes in which that function can be used are indicated by icons.



[Org./Paper/Finishing]

Access to the function is indicated by icons.

Example: Select [Org./Paper/Finishing] in the Copy screen to use the function.



[Org./SendData Format]

Access to the function is indicated by icons.

Example: Select [Org./SendData Format] in the Send screen to use the function.



[Functions]

Access to the function is indicated by icons.

Example: Select [Functions] in the Custom Box screen to use the function.



[Functions]

Access to the function is indicated by icons.

Example: Select [Functions] in the USB Drive screen to use the function.

Original Size

 [Org./Paper/Finishing]

 [Org./SendData Format]

 [Functions]

 [Functions]

Specify the original size to be scanned. Select [Auto (Standard Size)], [Auto (Non-standard Size)], [Metric], [Inch] or [Others] to select the sending size.

[Auto (Standard Size)]

Value	Description
—	Have the size of original detected automatically Displayed if "Auto (Standard Size)" is set to [On] in the System menu. ➔ Auto Detect Original Size (page 428)

[Auto (Non-standard Size)]

Value	Description
—	Scans non-standard size originals, and automatically measures and sets the original size.

[Metric]

Value	Description
A4, A5-R, A6, B5, B6, Folio, 216 × 340 mm	Select from the Metric series standard sizes.

[Inch]

Value	Description
Letter, Legal, Statement, Oficio II, Executive	Select from the Inch standard size.

[Others]

Value	Description
16K, Hagaki (Cardstock), Oufukuhagaki (Return postcard), Custom, Envelope Monarch, Envelope #10, Envelope #9, Envelope #6, Envelope DL, Envelope C5, ISO B5, Youkei 2, Youkei 4, Nagagata 3, Nagagata 4, Younaga 3	Select from special standard sizes and custom sizes. For instructions on how to specify the custom original size, refer to the following: ➔ Custom Original Size (page 428)

 **NOTE**

For details, refer to the following: Be sure to always specify the original size when using custom size original.

Paper Selection

 [Org./Paper/Finishing]

 [Functions]

 [Functions]

Select the cassette or multipurpose tray that contains the required paper size. If [Auto] is selected, paper the same size as the original is automatically selected.

NOTE

- Specify in advance the size and type of the paper loaded in the cassette.
 - ➔ [Paper Feeding \(page 430\)](#)
- Cassettes after Cassette 2 are displayed when the optional paper feeder is installed.

To change the paper size and media type of the multipurpose tray, select [Change Multipurpose Tray Settings] and change the Paper Size and Media Type. The available paper sizes and media types are shown in the table below.

Paper Size

[Metric]

Value	Description
A4, A5-R, A5, A6, B5, B6, Folio, 216 × 340 mm	Select from the Metric series standard sizes.

[Inch]

Value	Description
Letter, Legal, Statement, Statement-R, Executive, Oficio II	Select from the Inch series standard sizes.

[Others]

Value	Description
16K, ISO5, Envelope #10, Envelope #9, Envelope #6, Envelope Monarch, Envelope DL, Envelope C5, Hagaki (Cardstock), Oufuku Hagaki (Return postcard), Youkei 4, Youkei 2, Younaga 3, Nagagata 3, Nagagata 4, Custom*1	Select from special standard sizes and custom sizes.

[Size Entry]

Value	Description
Metric X: 148 to 457 mm (in 1 mm increments) Y: 98 to 320 mm (in 1 mm increments)	Enter the size not included in the standard size.* ² If [Size Entry] is selected, use [+], [-], or the numeric keys to set the size of "X" (width) and "Y" (length).
Inch X: 5.83 to 18" (in 0.01" increments) Y: 3.86 to 12.60" (in 0.01" increments)	

*1 For instructions on how to specify the custom paper size, refer to the following:

➔ [\[Custom Paper Settings\] \(page 432\)](#)

*2 The input units can be changed in System Menu.

➔ [Measurement \(page 420\)](#)

Media Type**Value**

Plain, Transparency, Thin, Labels, Recycled, Preprinted*¹, Bond, Cardstock, Color, Prepunched*¹, Letterhead*¹, Thick, Envelope, Coated, High Quality, Index Tab Dividers, Custom 1 to 8*¹

*1 To print on preprinted or prepunched paper or on letterhead, refer to the following:

➔ [Special Paper Action \(page 436\)](#)

For instructions on how to specify the custom paper types 1 to 8, refer to the following:

➔ [\[Media Type Setting\] \(page 434\)](#)

 NOTE

- You can conveniently select in advance the size and type of paper that will be used often and set them as default.
➔ [\[MP Tray Settings\] \(page 431\)](#)
- If paper of the specified paper size is not loaded in the paper source cassette or multipurpose tray, the confirmation screen appears. When the setting is [Auto], if the detected size of paper is not loaded, a paper confirmation screen appears. Load the required paper in the multipurpose tray and select [Continue]. Copying begins.

Mixed Size Originals

 [Org./Paper/Finishing]

 [Org./SendData Format]

 [Functions]

 [Functions]

Scan the documents of different sizes that are set in the document processor all at once. This function cannot be used if platen is used.

Copying

Value	Description
[Off]	—
[Same Width]	Scans and copies multiple sheets of the same width using the document processor.
[Different Width]	Scans and copies multiple sheets of different width using the document processor.

Sending/Sorting

Value	Description
[Off]	—
[Same Width]	Scans and sends/stores multiple sheets of the same width using the document processor.
[Different Width]	Scans and sends/stores multiple sheets of different width using the document processor.

Supported Combinations of Originals

[Same Width]

When the original widths are the same, the combinations of originals that can be placed are as follows.

- A4 and Folio (Legal and Letter)

Example: Folio and A4

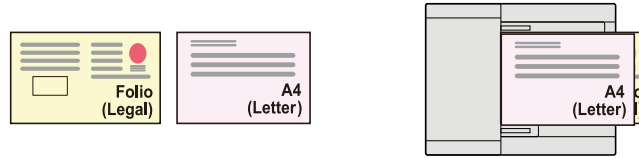

[Different Width]

The supported combinations of originals are as follows.

- Letter, A4, Folio, Legal

Example: A4, Legal

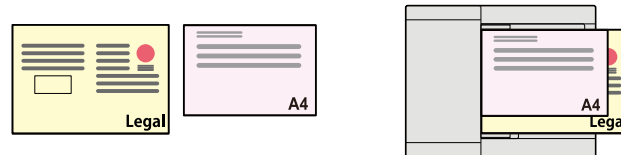

✔ IMPORTANT

When placing originals of different width, arrange the originals so that their left sides and top sides are aligned, and place the originals in alignment with the far width guide. If the originals are not aligned in this way, they may not be scanned correctly, and skewing or original jams may result.

Copy Size

Originals are detected individually for size and copied to the same size paper as originals.



NOTE

This function is available regardless of whether originals have the same width or not.

Original Orientation

Copy [Org./Paper/Finishing]

Send [Org./SendData Format]

Custom Box [Functions]

USB Drive [Functions]

Select the orientation of the original document top edge to scan correct direction.

To use any of the following functions, the document's original orientation must be set.

- Zoom
- Duplex
- Border Erase, Border Erase/Full Scan
- Combine
- Duplex

 **NOTE**

If On is selected in the setting for Original Orientation in System Menu, the selection screen for original orientation appears when you select any of the above functions.

➔ [Orientation Confirmation \(page 439\)](#)

Select the orientation of the original from [Top Edge on Top], [Top Edge on Left] or [Auto].

[Top Edge on Top]

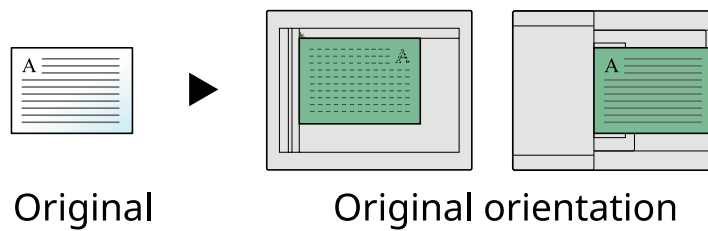

[Top Edge on Left]

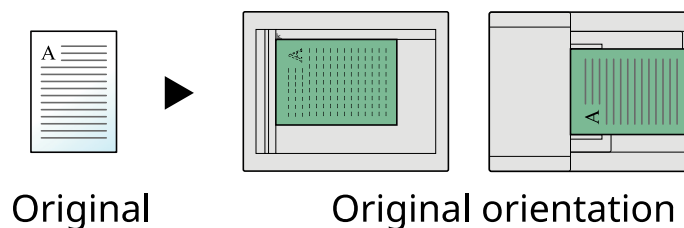

[Auto]

This function can only be used when the optional OCR Scan Activation Kit is installed.



NOTE

The default setting for Original Orientation can be changed.

➔ [Orientation Confirmation \(page 439\)](#)

Collate

Copy [Org./Paper/Finishing]

Custom Box [Functions]

USB Drive [Functions]

Prints the output by set.

Off

On

Scans multiple originals and delivers complete sets of copies as required according to page number.

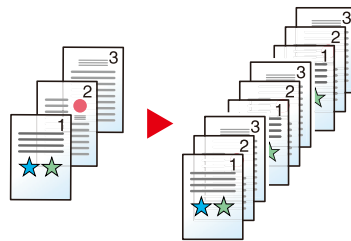

ID Card Copy



[Org./Paper/Finishing]

Use this when you want to copy a driver's license or an insurance card. When you scan the front and back of the card, both sides will be combined and copied onto a single sheet.

(Value: Off / On)

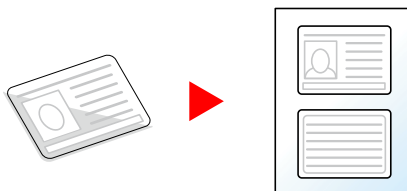

Density

Copy [Color/ImageQuality]

Send [Color/ImageQuality]

Custom Box [Functions]

USB Drive [Functions]

Make the print darker or lighter.

Select [-4] to [4] (lighter to darker) to set the darkness.



Original Image

 [Color/ImageQuality]

 [Color/ImageQuality]

 [Functions]

 [Functions]

Select original image type for best results.

Original Image Quality (Copy)

[Text+Photo]

Highlighter Enhancement

Value	Description
[Off], [On (Normal)], [On (Bright)]	Select [On (Normal)] to reproduce the color of the text and markings made with highlighter pen. If the colors are not bright enough, select [On (Bright)].

NOTE

If gray text is not printed completely using [Text+Photo], selecting [Text] may improve the result.

[Photo]

Best for photos taken with a camera.

[Text]

Highlighter Enhancement

Value	Description
[Off], [On (Normal)], [On (Bright)]	Select [On (Normal)] to reproduce the color of the text and markings made with highlighter pen. If the colors are not bright enough, select [On (Bright)].

[Printer Output]**Highlighter Enhancement**

Value	Description
[Off], [On (Normal)], [On (Bright)]	Select [On (Normal)] to reproduce the color of the text and markings made with highlighter pen. If the colors are not bright enough, select [On (Bright)].

[Graphic/Map]**Highlighter Enhancement**

Value	Description
[Off], [On (Normal)], [On (Bright)]	Select [On (Normal)] to reproduce the color of the text and markings made with highlighter pen. If the colors are not bright enough, select [On (Bright)].

Org. Image Quality (Send/Print/Store)**[Text+Photo]**

Best for mixed text and photo documents.

Highlighter Enhancement

Value	Description
[Off], [On (Normal)], [On (Bright)]	Select [On (Normal)] to reproduce the color of the text and markings made with highlighter pen. If the colors are not bright enough, select [On (Bright)].

[Photo]

Best for photos taken with a camera.

[Text]**Light Text/Fine Line**

Value	Description
Off	Best for documents that are mostly text and were originally printed on this machine.
On	Sharply renders pencil text and fine lines.

Highlighter Enhancement

Value	Description
[Off], [On (Normal)], [On (Bright)]	Select [On (Normal)] to reproduce the color of the text and markings made with highlighter pen. If the colors are not bright enough, select [On (Bright)].

[Text(for OCR)]

Scanning produces an image that is suitable for OCR. This function is only available when Color Selection is set to Black and White.

➔ [Color Selection \(page 337\)](#)

EcoPrint

Copy [Color/ImageQuality]

Custom Box [Functions]

USB Drive [Functions]

EcoPrint saves toner when printing. Use this function for test prints or any other occasion when high quality print is not required.

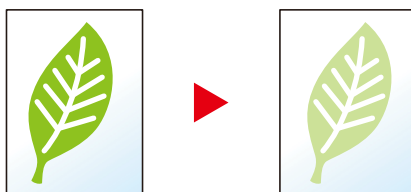

Value: Off, On

Color Selection

 [Color/ImageQuality]

 [Color/ImageQuality]

 [Functions] [Color/ImageQuality]

 [Functions] [Color]

Select the color setting.

Copying

Item	Description
[Auto Color]	Automatically recognizes whether documents are color or black and white.
[Full Color]	Prints documents in full color.
[Black & White]	Prints documents in black and white.

Sending/Storing

Item	Description
[Auto Color (Color/Grayscale)]	Automatically recognizes whether the document is color or black and white, and scan color documents in Full Color and black and white documents in Grayscale.
[Auto Color (Color/B & W)]	Automatically recognizes whether the document is color or black and white, and scan color documents in Full Color and black and white documents in Black and White.
[Full Color]	Scans the document in full color.
[Grayscale]	Scans the document in grayscale. Produces a smooth, detailed image.
[Black & White]	Scans the document in black and white.

Color Balance

 [Color/ImageQuality]

Adjust the strength of cyan, magenta, yellow, and black.

Less Magenta



Original



More Magenta



[Off]

[On]

Item	Description
[Cyan]	Move the cursor to adjust each color ("Cyan", "Magenta", "Yellow", "Black"). Value: [-5] to [5]
[Magenta]	
[Yellow]	
[Black]	

 **NOTE**

This feature is used with full color and auto color copying.

Hue Adjustment

Copy

[Color/ImageQuality]

Adjust the color (hue) of images.

Make adjustments such as adjusting red to a strong yellow-red or yellow to a strong green-yellow to make more creative copies.

Original



When adjusting yellow to more green, blue to more magenta (the ▼ part)

When adjusting yellowish-red to more yellow, bluish-cyan to more blue (the ▼ part)

The following settings can be set.

Item	Description
[Off]	—
[All]	Adjust hue for all colors. Select \odot or \odot to adjust the hue.
[Individual]	Select individual colors to adjust the hue. Select [Red], [Magenta], [Blue], [Yellow], [Green] or [Cyan] and select \odot or \odot to adjust the hue.

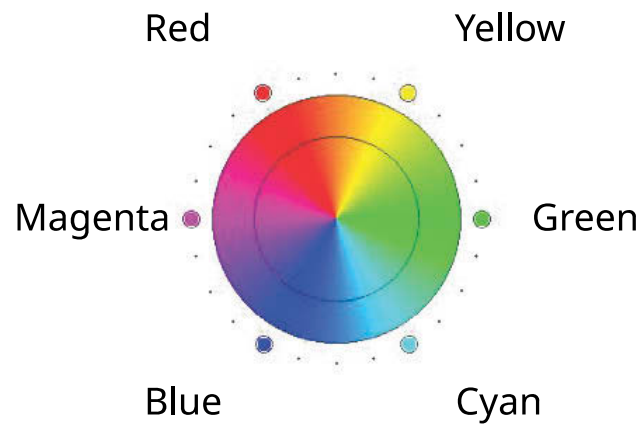

 **NOTE**

- This feature is used with full color and auto color copying.
 - These adjustments are especially useful on rich color images.
-

Sharpness

Copy [Color/ImageQuality]

Send [Color/ImageQuality]

Custom Box [Functions]

USB Drive [Functions]

Adjusts the sharpness of image outlines.

When copying penciled originals with rough or broken lines, clear copies can be taken by adjusting sharpness toward "Sharpen". When copying images made up of patterned dots such as magazine photos, in which moire^{*1} patterns appear, edge softening and weakening of the moire effect can be obtained by setting the sharpness toward "Blur".

Less Sharp



Original



More Sharp

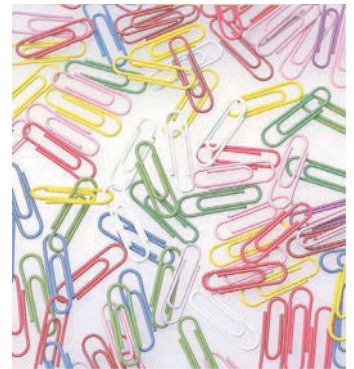

Value	Description
[1] to [3] (Sharpen)	Emphasizes the image outline.
[-1] to [-3] (Blur)	Blurs the image outline. Can weaken a Moire ^{*1} effect.

*1 Patterns that are created by irregular distribution of halftone dots.

Background Density Adj.

 [Color/ImageQuality]

 [Color/ImageQuality]

 [Functions]

 [Functions]

Removes dark background from originals, such as newspapers.

If the background color is obtrusive, select [Auto]. If selecting [Auto] does not remove the background color, select [Manual] and adjust the density of the background color.

Item	Description
[Off]	Does not adjust the ground color.
[Auto]	Automatically adjusts the background density based on the original.
[Manual]	Select [1] to [7] (Lighter to Darker) to adjust the background density manually.

Saturation



[Color/ImageQuality]

Adjust the color saturation of the image.

Grayish



Results in paler color.

Original



Vivid



Results in more vivid color.

NOTE

This feature is used with full color and auto color. Saturation is disabled if Auto Color detects black and white originals.

Item	Description
[-1] to [-3] (Grayish)	Results in paler color.
[1] to [3] (Vivid)	Results in more vivid color.

Prevent Bleed-thru

Copy [Color/ImageQuality]

Send [Color/ImageQuality]

Custom Box [Functions]

USB Drive [Functions]

Hides background colors and image bleed-through when scanning thin original.

(Value: Off / On)

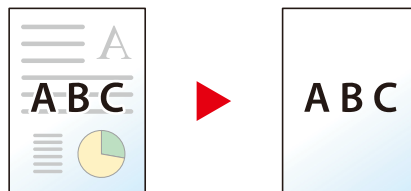

Contrast

Copy [Color/ImageQuality]

Send [Color/ImageQuality]

Custom Box [Functions]

USB Drive [Functions]

Adjust the contrast between light and dark of the image.

Lower



Original





Higher



Item	Description
[1] to [4] (Higher)	Increases the sharpness of colors.
[-1] to [-4] (Lower)	Creates smoother colors.

Erase Colors

 [Color/ImageQuality]

 [Color/ImageQuality]

 [Functions]

 [Functions]

Erases colors in the source document.

[Off]

[On]

Value	Description
[Yellow], [Red], [Cyan], [Magenta], [Green], [Blue], [Black]	Select the colors to erase. You can select up to 6 colors.

Color Range

Value	Description
[1] (Narrower) to [5] (Wider)	Choose a range of colors to erase. For example, if you specify [Yellow] and select [5] (Wider) from the color range, greens and reds close to yellow will be erased.

NOTE

If you select only [Black], you cannot set the "Color Range".

Zoom

Copy [Layout/Edit]

Send [AdvancedSetup]

Custom Box [Functions]

USB Drive [Functions]

Adjust the zoom to reduce or enlarge the image.

Copying

The following zoom options are available.

Auto

Adjusts the image to match the paper size.

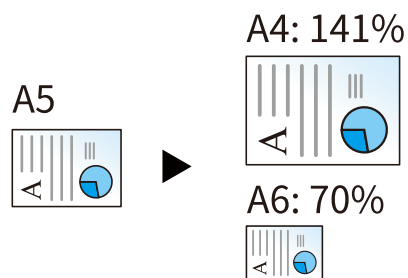

Standard Zoom

[400%]	Maximum
[200%]	—
[141%]	A5→A4
[129%]	Statement→Letter
[115%]	B5→A4
[90%]	Folio→A4
[86%]	A4→B5
[78%]	Legal→Letter
[70%]	A4→A5-R
[64%]	Letter→Statement-R
[50%]	—
[25%]	Minimum

Zoom Entry

Manually reduces or enlarges the original image in 1% increments between 25% and 400%. Use [+], [-] or the numeric keys to set the value.

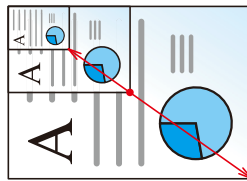

Printing/Sending/Storing

Item	Description
[100%]	Reproduces the original size.
[Auto]	Reduces or enlarges original to sending/storing size.

NOTE

- To reduce or enlarge the image, select the paper size, sending size, or storing size.
 - ➔ [Paper Selection \(page 323\)](#)
 - ➔ [Sending Size \(page 370\)](#)
 - ➔ [Storing Size \(page 391\)](#)

Combine

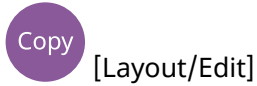

[Layout/Edit]

Combines 2 or 4 original sheets into 1 printed page.

You can select the page layout and the type of boundary lines around the pages.

The following types of the boundary lines are available.

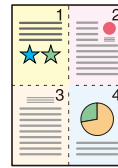

None

Solid Line

Dotted Line

Positioning Mark

[Off]

[2 in 1]

Layout

Value	Description
[Left to Right/Top to Bottom], [Right to Left/Bottom to Top]	Select the page layout of scanned originals.

Border Line

Value	Description
[None], [Solid Line], [Dotted Line], [Positioning Mark]	Select the boundary line type.

Original Orientation

Value	Description
[Top Edge on Top], [Top Edge on Left], [Auto] ^{*1}	Select the orientation of the original document top edge to scan correct direction. Select the orientation of the original from [Top Edge on Top] or [Top Edge on Left].

[4 in 1]

Layout

Value	Description
[Right then Down], [Left then Down], [Down then Right], [Down then Left]	Select the page layout of scanned originals.

Border Line

Value	Description
[None], [Solid Line], [Dotted Line], [Positioning Mark]	Select the boundary line type.

Original Orientation

Value	Description
[Top Edge on Top], [Top Edge on Left], [Auto]* ¹	Select the orientation of the original document top edge to scan correct direction. Select the orientation of the original from [Top Edge on Top] or [Top Edge on Left].

*1 This function can only be used when the optional OCR Scan Activation Kit is installed.

Layout image (2 in 1)

[Left to Right/Top to Bottom]

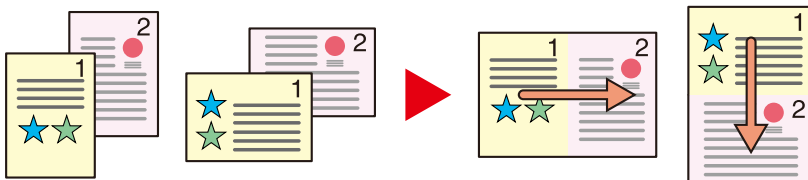

[Right to Left/Bottom to Top]

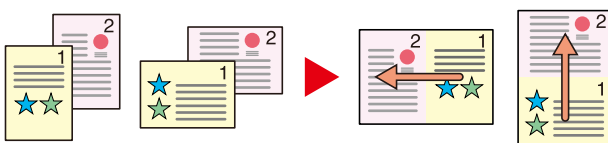

Layout image (4 in 1)

[Right then Down]

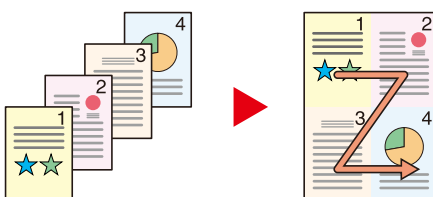

[Left then Down]

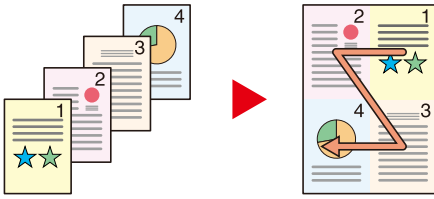

[Down then Right]

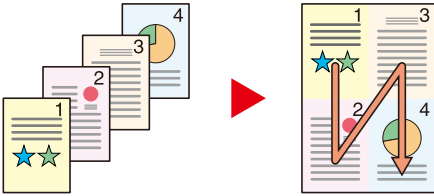

[Down then Left]

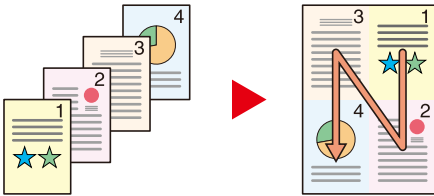

 **NOTE**

- The paper sizes supported in Combine mode are A4, A5-R, B5, Folio, 216 × 340 mm, Letter, Legal, Statement-R, Oficio II, and 16K.
 - When placing the original on the platen, be sure to copy the originals in page order.
-

Border Erase, Border Erase/Full Scan

Copy [Layout/Edit]

Send [AdvancedSetup]

Custom Box [Functions]

USB Drive [Functions]

Erases the black frame created in the original. The border can be erased as follows:

Standard

Erase the black frame created in the original. Erasing width is fixed.

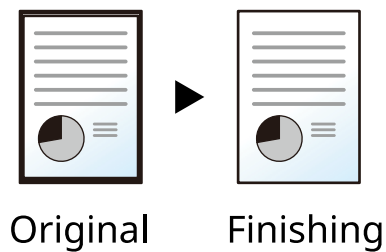

Full Scan

Scan originals without white margins. No border erase.

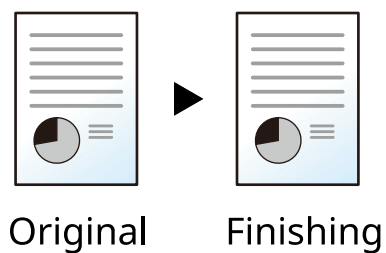

Border Erase Sheet

Erase the black frame created in the original. Erasing width can be adjusted.



[Border]

Value	Description
Centimeters: 0 mm - 50 mm (in 1 mm increments), Inches: 0.00 - 2.00" (in 0.01" increments)	Set the border erase width.*1 Set the value by using [+] or [-]. Entry can also be made using the numeric keys.

[Back Page]

Value	Description
[Same as Front Page], [Do Not Erase]	For 2-sided originals, select [Back Page] and then select [Same as Front Page] or [Do Not Erase].

Border Erase Book

Erases black borders around the edges and in the middle of the original such as a thick book. You can specify the widths individually to erase the borders around the edges and in the center of the book.

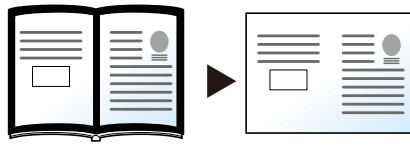

Original

Finishing

[Border]

Value	Description
Centimeters: 0 mm - 50 mm (in 1 mm increments), Inches: 0.00 - 2.00" (in 0.01" increments)	Set the border erase width.*1 Set the value by using [+] or [-]. Entry can also be made using the numeric keys.

[Back Page]

Value	Description
[Same as Front Page], [Do Not Erase]	For 2-sided originals, select [Back Page] and then select [Same as Front Page] or [Do Not Erase].

Individual Border Erase

You can specify border erase widths individually for all edges.



[Border]

Value	Description
Centimeters: 0 mm - 50 mm (in 1 mm increments), Inches: 0.00 - 2.00" (in 0.01" increments)	Set the border erase width.* ¹ Set the value by using [+] or [-]. Entry can also be made using the numeric keys.

[Back Page]

Value	Description
[Same as Front Page], [Do Not Erase]	For 2-sided originals, select [Back Page] and then select [Same as Front Page] or [Do Not Erase].

[Original Orientation]

Value	Description
[Top Edge on Top], [Top Edge on Left], [Auto]* ²	Select the orientation of the original document top edge to scan correct direction. Select [Original Orientation] to choose orientation of the originals, either [Top Edge on Top] or [Top Edge on Left].

NOTE

- [Full Scan] is not displayed when copying.
- The default setting for border erase width can be changed. For details, refer to the following:
➔ [Border Erase Default \(page 449\)](#)
- The default setting for back page can be changed. For details, refer to the following:
➔ [Border Erase to Back Page \(page 449\)](#)

*1 The input units can be changed in System Menu. For details, refer to the following.

➔ [Measurement \(page 420\)](#)

*2 This function can only be used when the optional OCR Scan Activation Kit is installed.

Duplex

Copy [Layout/Edit]

USB Drive [Functions]

Produces two-sided copies. You can also create single-sided copies from two-sided originals.

The following modes are available.

1-sided>>2-sided

Produces two-sided copies from one-sided originals. In case of an odd number of originals, the back side of the last copy will be blank.

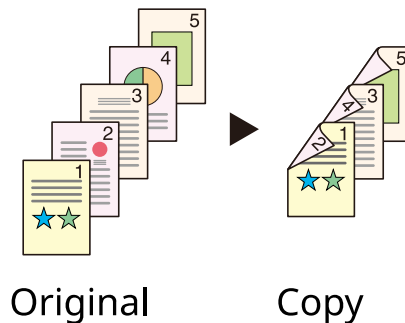

The following binding options are available.

- 1 Binding Left/Right: Images on the second sides are not rotated.
- 2 Binding Top: Images on the second sides are rotated 180 degrees. Copies can be bound on the top edge, facing the same orientation when turning the pages.

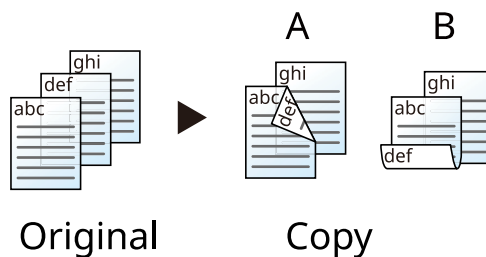

2-sided>>1-sided

Copies each side of a two-sided original onto two individual sheets. Place originals in the document processor. The following binding options are available.

- Binding Left/Right: Images on the second sides are not rotated.
- Binding Top: Images on the second sides are rotated 180 degrees.

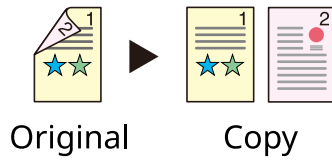

2-sided>>2-sided

Produces two-sided copies from two-sided originals. Place originals in the document processor.

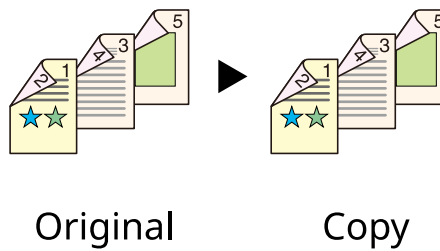

NOTE

The paper sizes supported in Duplex mode: A4, A5-R, A5, A6, B5, B6-R, Letter, Legal, Statement-R, Statement, Executive, Oficio II, Folio, 16K, ISO B5

Copying

Prints 1-sided originals to 2-sided, or 2-sided originals to 1-sided. Select the binding orientation for original and finished documents.

[1-sided]>>1-sided]

Disables the function.

[1-sided]>>2-sided]

Finishing

Value	Description
[BindingLeft/Right], [BindingTop]	Select binding orientation.

Original Orientation

Value	Description
[Top Edge on Top], [Top Edge on Left], [Auto] ^{*1}	Select the orientation of the original document top edge to scan correct direction. Select the orientation of the original from [Top Edge on Top] or [Top Edge on Left].

[2-sided]>>1-sided]

Original

Value	Description
[BindingLeft/Right], [BindingTop]	Select the binding direction of originals.

Original Orientation

Value	Description
[Top Edge on Top], [Top Edge on Left], [Auto] ^{*1}	Select the orientation of the original document top edge to scan correct direction. Select the orientation of the original from [Top Edge on Top] or [Top Edge on Left].

[2-sided]>>2-sided]

Original

Value	Description
[BindingLeft/Right], [BindingTop]	Select the binding direction of originals.

Finishing

Value	Description
[BindingLeft/Right], [BindingTop]	Select binding orientation.

Original Orientation

Value	Description
[Top Edge on Top], [Top Edge on Left], [Auto] ^{*1}	Select the orientation of the original document top edge to scan correct direction. Select [Original Orientation] to choose orientation of the originals, either [Top Edge on Top] or [Top Edge on Left].

*1 This function can only be used when the optional OCR Scan Activation Kit is installed.

When placing the original on the platen, consecutively replace each original and press the [Start] key.

After scanning all originals, select [Finish Scan] to start copying. Copying begins.

Duplex (During printing)

Prints the document on both sides.

[1-sided]

Disables the function.

[Duplex]

Binding

Value	Description
[Left/Right]	Prints on both sides so that the correct orientation is achieved when binding the paper on the left or right.
[Top]	Prints on both sides so that the correct orientation is achieved when binding the paper at the top.

Continuous Scan

 [AdvancedSetup]

 [AdvancedSetup]

 [Functions]

 [Functions]

Scan several sets of originals separately and process them as one job.

Scanning of originals will continue until [Finish Scan] is selected.

Turn the setting On to perform continuous scanning.

(Value: Off/On)

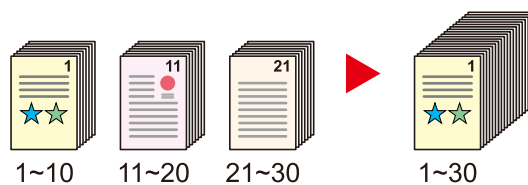

Job Finish Notice

 [AdvancedSetup]

 [AdvancedSetup]

 [Functions]

 [Functions]

Sends E-mail notice when a job is complete.

It can also be set up to send a notice when a job is interrupted.

Users can be notified of the completion of a job while working at a remote desk, saving the time spent waiting beside the machine to finish.

NOTE

- PC should be configured in advance so that E-mail can be used. For details, refer to the following:
 ➔ [Command Center RX \(page 121\)](#)
- E-mail can be sent to a single destination.
- It is possible to download the scan data to PC from the URL provided in the Job Finish Notice E-mail in the event of "Send to Folder (SMB/FTP)" or "Storing Documents to a Custom Box". This is a useful function in case if it is not possible to send/receive a large amount of scan data due to the restriction of the mail attachment file size.

Item	Description
[Off]	—
[Addr. Book]	<p>[Addr. Book] Select the notification destination on the address book screen, then select [OK].</p> <p> (information icon) Information on the selected destination can be viewed.</p> <p>[Notify when interrupted] Select On if you require an e-mail notification when a job is interrupted.</p>
[Address Entry]	<p>Email Address Enter E-mail address directly. Select the entry field, enter the address (up to 256 characters) and select [OK].</p> <p>[Notify when interrupted] Select On if you require an e-mail notification when a job is interrupted.</p>

File Name Entry

 [AdvancedSetup]

 [Functions]

 [Functions]

Adds a file name in the document.

Additional information such as job number and date and time can also be set. You can check a job history or job status using the file name, date and time, or job number specified here.

Enter the file name (up to 32 characters).

To add a date and time, select [Date and Time]. To add a job number, select [Job No.]. To add both, select [[Job No.] & [Date and Time]] or [[Date and Time] & [Job No.]

Priority Override



[AdvancedSetup]



[Functions]



[Functions]

Suspends the current job and gives a new job top priority.

The suspended job resumes after the other job is finished.

(Value: Off/On)



NOTE

- This function is not available if current job was an override.
-

Quiet Mode

 [AdvancedSetup]

 [Functions]

 [Functions]

The operating sound of the machine can be suppressed. Set Quiet Mode if you are concerned about the operating sound.

You can configure each function, including Copy, Send, and so on, to use Quiet Mode.

Value: On/Off

 **NOTE**

In Quiet Mode, the processing speed will be slower than normal. Not available when [Prohibit] is selected in "Specify Each Job".

➔ [Specify Each Job \(page 450\)](#)

Detect Multi-fed Originals

 [AdvancedSetup]

 [AdvancedSetup]

 [Functions]

 [Functions]

When scanning a document from the document processor, scanning is automatically stopped when multiple pages are fed together.

This function is available only for TASKalfa MA4500ci.

Value	Description
On	In case of detecting that multiple sheets of original are fed at the same time, the message is displayed and stop scanning the original.
Off	It does not detect.

Detect Folded Corner Orig.

 [AdvancedSetup]

 [AdvancedSetup]

 [Functions]

 [Functions]

When scanning a document from the document processor, scanning is automatically stopped when a document with a folded corner is detected.

Value	Description
On	If a bent corner is detected, a message is displayed to stop reading the original.
Off	It does not detect.

Skip Blank Page

 [AdvancedSetup]

 [AdvancedSetup]

 [Functions]

 [Functions]

When there are blank pages in a scanned document, this function skips the blank pages and prints only pages that are not blank.

Blank pages can be set as pages that include ruled lines and a small number of characters.

The machine detects blank pages, saving unnecessary printing without the need to check for blank pages in the document.

Select [On] > [Detect Items to Skip] and choose [Blank Pages + Ruled Lines], [Blank Pages Only], or [Blank Pages + Some Text].

 **NOTE**

The originals with punched holes or originals printed on a colored substrate may not be recognized as blank pages.

Duplex

 [Org./SendData Format]

 [Functions]

 [Functions]

Select the type and orientation of the binding based on the original.

[1-sided]

There is no setting for the binding or the original orientation.

[2-sided]

Binding

Value	Description
[Left/Right], [Top]	Select the binding orientation of originals.

Original Orientation

Value	Description
[Top Edge on Top], [Top Edge on Left], [Auto] ^{*1}	Select the orientation of the original document top edge to scan correct direction. Select the orientation of the original from [Top Edge on Top] or [Top Edge on Left].

*1 This function can only be used when the optional OCR Scan Activation Kit is installed.

Sample image

[2-sided] > [Left/Right]



[2-sided] > [Top]



Sending Size

 Send

[Org./SendData Format]

Select size of image to be sent.

Select [Same as Original Size], [Metric], [Inch], or [Others] to select the sending size.

[Same as Original Size]

Automatically sends the same size as the original.

[Metric]

Value	Description
A4, A5, A6, B5, B6, Folio, 216 × 340 mm	Select from the Metric series standard sizes.

[Inch]

Value	Description
Letter, Legal, Statement, Executive, Oficio II	Select from the Inch series standard sizes.

[Others]

Value	Description
16K, Hagaki, Oufukuhagaki, Envelope Monarch, Envelope #10, Envelope #9, Envelope #6, Envelope DL, Envelope C5, ISO B5, Youkei 2, Youkei 4, Nagagata 3, Nagagata 4, Younaga 3	Select from special standard sizes.

Relationship between Original Size, Sending Size, and Zoom

Original Size, Sending Size, and Zoom are related to each other. For details, see the table below.

- Original size and sending size are the same

Original Size

Specify as necessary.

➔ [Original Size \(page 321\)](#)

Sending Size

Select [Same as Original Size].

Zoom

Select [100%] (or [Auto]).

➔ [Zoom \(page 347\)](#)

- Original size and sending size are different

Original Size

Specify as necessary.

➔ [Original Size \(page 321\)](#)

Sending Size

Select the desired size.

Zoom

Select [Auto].

➔ [Zoom \(page 347\)](#)

NOTE

When you specify the sending size that is different from the original size and select the zoom of [100%], you can send the image as the actual size (no zoom).

Long Original



[Org./SendData Format]



[Functions]

Reads long-sized original documents using a document processor.

(Value: Off / On)



NOTE

- Long originals are sent in black and white.
 - Only a single side of a long original can be scanned. Originals of up to 915 mm / 74.8" long can be scanned.
 - A resolution of 300 × 300 dpi or smaller can be selected.
-

File format

Send [Org./SendData Format]

Custom Box [Functions]

USB Drive [Functions]

Specify the image file format. Image quality level can also be adjusted.

Select the file format from [PDF], [TIFF], [XPS], [JPEG], [OpenXPS], [High Comp. PDF], [Word], [Excel] or [PowerPoint].

When the color mode in scanning has been selected for Grayscale or Full Color, set the image quality.

If you selected [PDF] or [High Comp. PDF], you can specify encryption or PDF/A settings.

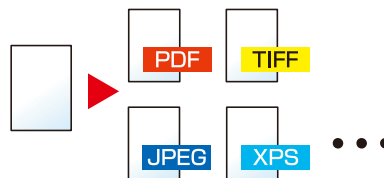

[PDF]

Value	Description
1 Low Quality (High Comp) to 5 High Quality (Low Comp)	Color Mode: Auto Color (Color/Grayscale), Auto Color (Color/ Black and White), Full Color, Grayscale, Black and White

NOTE

- You can create Searchable PDF file by running OCR on the scanned document.
➔ [OCR Text Recognition \(Option\) \(page 376\)](#)
- Set the PDF/A. (Value: [Off] [PDF/A-1a] [PDF/A-1b] [PDF/A-2a] [PDF/A-2b] [PDF/A-2u])
- Set PDF encryption.
➔ [PDF Encryption Functions \(page 377\)](#)
- Set Digital Signature to File.
➔ [PDF Electronic Signature \(page 380\)](#)

[TIFF]

Value	Description
1 Low Quality (High Comp) to 5 High Quality (Low Comp)	Color mode: Auto Color (Color/Grayscale), Full Color, Grayscale

[JPEG]

Value	Description
1 Low Quality (High Comp) to 5 High Quality (Low Comp)	Color mode: Auto Color (Color/Grayscale), Full Color, Grayscale

[XPS]

Value	Description
1 Low Quality (High Comp) to 5 High Quality (Low Comp)	Color Mode: Auto Color (Color/Grayscale), Auto Color (Color/ Black and White), Full Color, Grayscale, Black and White

[OpenXPS]

Value	Description
1 Low Quality (High Comp) to 5 High Quality (Low Comp)	Color Mode: Auto Color (Color/Grayscale), Auto Color (Color/ Black and White), Full Color, Grayscale, Black and White

[High Comp. PDF]

Value	Description
[Compression Ratio Priority], [Standard], [Quality Priority]	Color Mode: Auto Color (Color/Grayscale), Auto Color (Color/ Black and White), Full Color, Grayscale

**NOTE**

- You can create Searchable PDF file by running OCR on the scanned document.
➔ [OCR Text Recognition \(Option\) \(page 376\)](#)
- Set the PDF/A. (Value: [Off] [PDF/A-1a] [PDF/A-1b] [PDF/A-2a] [PDF/A-2b] [PDF/A-2u])
- Set PDF encryption.
➔ [PDF Encryption Functions \(page 377\)](#)
- Set Digital Signature to File.
➔ [PDF Electronic Signature \(page 380\)](#)

[Word]

Value	Description
1 Low Quality (High Comp) to 5 High Quality (Low Comp)	Color mode: Auto Color (Color/Grayscale), Full Color, Grayscale

**NOTE**

- This function can only be used when the optional OCR Scan Activation Kit is installed.
- It is saved as a Microsoft Office 2007 or later file format.
➔ [Scan to Office Function \(page 379\)](#)

[Excel]

Value	Description
1 Low Quality (High Comp) to 5 High Quality (Low Comp)	Color mode: Auto Color (Color/Grayscale), Full Color, Grayscale

**NOTE**

- This function can only be used when the optional OCR Scan Activation Kit is installed.
- It is saved as a Microsoft Office 2007 or later file format.

➔ [Scan to Office Function \(page 379\)](#)

[PowerPoint]

Value	Description
1 Low Quality (High Comp) to 5 High Quality (Low Comp)	Color mode: Auto Color (Color/Grayscale), Full Color, Grayscale

**NOTE**

- This function can only be used when the optional OCR Scan Activation Kit is installed.
- It is saved as a Microsoft Office 2007 or later file format.

➔ [Scan to Office Function \(page 379\)](#)

OCR Text Recognition (Option)

When PDF, High Comp. PDF, Word, Excel, or PowerPoint is selected for the file format, you can create Searchable file by running OCR on the scanned document. Select [OCR Text Recognition] > and then On, select the language of the document, and select [OK].

Item	Description
Off	Do not create Searchable file.
On	Create Searchable file. Select the language to extract from the languages that appear on the touch panel.

NOTE

- This function can only be used when the optional OCR Scan Activation Kit is installed.
 - ➔ [Scan Extension Kit\(A\) AC <Scan function expansion kit \(Activate\)> \(page 745\)](#)
- This function cannot be set when you send from the Custom Box.
- If the proper language is not selected, file creation may take a long time or the creation may fail. The default language can be changed in System Menu.
 - ➔ [Primary OCR Language \(page 454\)](#)
- If you do not set an original in the correct orientation, the text of the document may not be recognized as characters. In addition, it may take some time to create the file. Check that the original orientation is correct.
- The accuracy of the text recognition depends on the original condition. The following condition may result in decreasing the recognition accuracy.
 - Repeatedly copied documents (as copied copy)
 - Received faxes (with low resolution)
 - Originals with the character space too narrow or wide
 - Originals with the lines on the text
 - Originals with the special fonts
 - Binding part of the book
 - A handwritten texts

PDF Encryption Functions

If you have selected PDF or High Comp. PDF for file format, you can restrict the access level for displaying, printing, and editing PDF's by assigning a secure password.

Select [PDF] or [High Comp. PDF] and select [Encryption].

Items that can be set vary depending on the setting selected in Compatibility.

If Acrobat 3.0 and later is selected

[Password to Open Document]

Value	Description
Off, On	Enter the password to open the PDF file. Select On, enter a password (up to 256 characters). Enter the password again for confirmation.

[Password to Edit/Print Document]

Value	Description
Off, On	Enter the password to edit the PDF file. Select On, enter a password (up to 256 characters). Enter the password again for confirmation. When you have entered the password to edit/print document, you can specifically limit the operation.

Printing Allowed

Value	Description
[Not Allowed], [Allowed]	Disables the printing of PDF file.

Changes Allowed

Value	Description
[Not Allowed]	Disables the change to the PDF file.
[Commenting]	Can only add commenting.
[Page Layout except extracting Pages]	Can change the page layout except extracting the pages of the PDF file.
[Any except extracting Pages]	Can conduct all operations except extracting the pages of the PDF file.

Copying of Text/Images/Others

Value	Description
[Disable], [Enable]	Restricts the copying of text and objects on the PDF file.

If Acrobat 5.0 and later is selected**[Password to Open Document]**

Value	Description
Off, On	Enter the password to open the PDF file. Select On, enter a password (up to 256 characters). Enter the password again for confirmation.

[Password to Edit/Print Document]

Value	Description
Off, On	Enter the password to edit the PDF file. Select On, enter a password (up to 256 characters). Enter the password again for confirmation. When you have entered the password to edit/print document, you can specifically limit the operation.

Printing Allowed

Value	Description
[Not Allowed]	Disables the printing of PDF file.
[Allowed (Low Resolution only)]	Can print the PDF file only in low resolution.
[Allowed]	Can print the PDF file in original resolution.

Changes Allowed

Value	Description
[Not Allowed]	Disables the change to the PDF file.
[Inserting/Deleting/Rotating Pages]	Can only insert, delete, and rotate the pages of the PDF file.
[Commenting]	Can only add commenting.
[Any except extracting Pages]	Can conduct all operations except extracting the pages of the PDF file.

Copying of Text/Images/Others

Value	Description
[Disable], [Enable]	Restricts the copying of text and objects on the PDF file.

Scan to Office Function

This machine provides the function which converts scanned documents including text, figures and pictures into searchable and editable Microsoft Office (Word, Excel and PowerPoint) 2007 or later data format, via OCR processing.

NOTE

- This function can only be used when the optional OCR Scan Activation Kit is installed.
 - ➔ [Scan Extension Kit\(A\) AC <Scan function expansion kit \(Activate\)> \(page 745\)](#)
 - The scanned result may not be realized perfectly according to condition of the documents.
-

1 Display the screen.

- 1 [Home] key > [Send] > [Org./SendData Format] > [File Format]

2 Configure the settings

- 1 Select [Word], [Excel] or [PowerPoint] as a file format.
 - 2 Select [OCR Text Recognition] > On.
-

NOTE

When you select Off, the documents are converted into the Microsoft Office data (scanned image).

- 3 Select the language of the document which you wish to scan > [OK].
- 4 Select [OCR Output Format] and set an OCR output mode from the following, and then select [OK].

[Text + Graphics]

Converts the scanned documents into the editable and searchable Microsoft Office data format.

[Text + Graphics with Scanned Image]

Converts the scanned documents into two types of data: one is the editable and searchable Microsoft Office data format and the other one is the Microsoft Office data format with scanned image. You can edit text and layout of the editable data by referring the scanned image.

[Scanned Image with Searchable Text]

Converts the scanned documents into the searchable Microsoft Office data format (scanned image).

3 Press the [Start] key.

PDF Electronic Signature

If [PDF] or [High Comp. PDF] is selected as a file format, electronic signature can be added to the PDF to be sent. Electronic signature can certify a sender of document and prevent falsification. To use this function, it is required to register a signing certificate from Command Center RX or KYOCERA Net Viewer and enable digital signature to files from the system menu. In this manual, a procedure to register a signing certificate from Command Center RX is described as an example.

NOTE

- This function can be configured when [Off], [PDF/A-2a], [PDF/A-2b], [PDF/A-2u] is selected in PDF/A.
- To register a signing certificate from KYOCERA Net Viewer, refer to the following.
 - ➔ **KYOCERA Net Viewer User Guide**

1 Access to Command Center RX.

➔ [Accessing Command Center RX \(page 122\)](#)

2 Register a signing certificate to be used in the electronic signature addition setting.

- 1 From the [Functions] menu, click [Customize Status Display].
- 2 Click [Settings] in [File Default Settings] > [Signing Certificate] to create or import the device certificate.
 - ➔ **Command Center RX User Guide**
- 3 Click [Restart/Reset] > [Restart entire device] to restart the device.

3 Configure the digital signature settings.

- 1 [System Menu / Counter] key > [FunctionSettings] > [Send/Store] > [Digital Signature to File]

NOTE

If the user authentication screen appears, log in with a user who has the privilege to configure this setting. If you do not know your login user name or password, please contact your administrator.

- 2 Configure the digital signature addition settings.

The following settings can be selected.

Digital Signature

Select whether to add a digital signature.

[Off]

Does not add a digital signature.

[Specify Each Job]

Whether to add a digital signature is selected each time of sending.

[On]

Always adds a digital signature when sending.

[Digital Signature Format]

Select an algorithm used for encryption of digital signature.

Value: [SHA-1], [SHA-256], [SHA-384], [SHA-512]



NOTE

This function is displayed when Digital Signature is set to [Specify Each Job] or [On].

Password Confirmation on Signature Permission

Select whether to confirm password when setting digital signature.

Value: [On], [Off]



NOTE

This function is displayed when Digital Signature is set to [Specify Each Job].

[Password]

Set a password required for setting digital signature. Enter a new security password 6 to 16 alphanumeric characters and symbols.



NOTE

This function is displayed when "Password Confirmation on Signature Permission" is set to [On].

3 Select [OK].

4 Display the screen.

1 [Home] key > [Send] > [Org./SendData Format] > [File Format]

5 Configure the settings.

1 Select [PDF] or [High Comp. PDF] as a file format.

2 From "Digital Signature", select [On] > [OK] in order.



NOTE

This function is displayed only when [Specify Each Job] is set in step 3-2.

If "Password Confirmation on Signature Permission" is set to [On], a password input screen appears. Enter a password set in the system menu.

➔ [Password \(page 456\)](#)

6 Press the [Start] key.

File Separation

Send [Org./SendData Format]

Custom Box [Functions]

USB Drive [Functions]

Creates multiple files for each scanned original data page.

(Values [Off]/[Each Page])

When you select [Each Page], the file size is recalculated.



 **NOTE**

A three-digit serial number such as "abc_001.pdf, abc_002.pdf..." is attached to the end of the file name.

Scan Resolution, Resolution

 [Color/ImageQuality]

 [Functions]

 [Functions]

Select fineness of scanning resolution.

(Values: [600 x 600 dpi]/[400 x 400 dpi Ultrafine]/[300 x 300 dpi]/[200 x 400 dpi Superfine]/[200 x 200 dpi Fine]/[200 x 100 dpi Normal])



 **NOTE**

The larger the number, the better the image resolution. However, better resolution also means larger file sizes and longer send times.

Clarify Text (Noise Removal)



[Color/ImageQuality]



[Functions]

When scanning and sending a document in black and white, it eliminates background noise and improves the legibility of characters.

Value: [Off]/[On]

Email Subject/Body

Send [AdvancedSetup]

Custom Box [Functions]

Adds subject and body when sending a document.

Select "Subject"/"Body" to enter the Email subject/body.

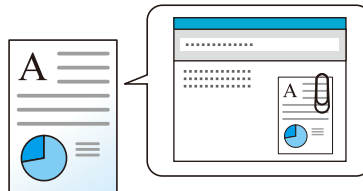

 **NOTE**

- The subject can include up to 256 characters, and the body can include up to 500 characters.
-

FTP Encrypted TX



[Advanced Setup]



[Functions]

Encrypts images when sending via FTP.

Encryption secures the document transmission.

(Value: Off / On)



NOTE

In Command Center RX, click [Security Settings]→ [Network Security] in order. Be sure that "TLS" of Secure Protocol Settings is [On] and one or more effective encryption are selected in Client side settings.

➔ **Command Center RX User Guide**

Email Encrypted TX



[AdvancedSetup]



[Functions]

Sends encrypted E-mail using the electronic certificate.

Encryption secures the document transmission.

(Value: Off/On)



NOTE

To use this function, configure the certificate, protocol and email function in the Command Center RX.

➔ [Configuring S/MIME in Command Center RX \(page 388\)](#)

Digital Signature to Email

 Send

[AdvancedSetup]

 Custom
Box

[Functions]

Add a digital signature to the email, using the electronic certificate.

By adding a digital signature to an email, you can confirm the identity of the destination and detect tampering during transmission.

(Value: Off / On)

**NOTE**

To use this function, configure the certificate, protocol and email function in Command Center RX.

➔ [Configuring S/MIME in Command Center RX \(page 388\)](#)

Configuring S/MIME in Command Center RX

When using the Email Encrypted TX and Digital Signature to Email functions, make the following settings in Command Center RX.

1 Access to Command Center RX.

➔ [Accessing Command Center RX \(page 122\)](#)

2 Register the device certificate which is used for S/MIME.

- 1 From the [Security Settings] menu, click [Certificates].
- 2 Click [Settings] of "Device Certificate" (1 to 5) to create or import the device certificate.
➔ **Command Center RX User Guide**
- 3 Click [Restart/Reset] > [Restart entire device] to restart the device.

3 Configure the protocol settings

- 1 From the [Network Settings] menu, click [Protocols].
- 2 Set [SMTP (E-mail TX)] and [S/MIME] of "Send Protocol" to [On].
- 3 Click [Submit].

4 Configure the E-mail function.

- 1 From the [Functions] menu, click [E-mail].
- 2 Configure the settings in "S/MIME Settings" as necessary.
➔ **Command Center RX User Guide**
- 3 Click [Submit].

5 Link the E-mail address with S/MIME certificates

- 1 From the [Address Book] menu, click [Machine Address Book].
- 2 Click the contact's [Number] or [Name] you want to edit.
- 3 Click [Settings] in "S/MIME Certificate".
- 4 Click [Import] on the required certificate to register it, and then click [Submit].
- 5 Click [OK].

Delete after Printed



[Functions]

Automatically deletes a document from the box once printing is complete.

(Value: Off/On)

Delete after Transmitted



[Functions]

Automatically deletes a document from the box once transmission is complete.

(Value: Off/On)

Storing Size



[Functions]



[Functions]

Select size of image to be stored.

Select [Same as Original Size], [Metric], [Inch], or [Others] to select the storing size.

[Same as Original Size]

Automatically sends the same size as the original.

[Metric]

Value	Description
A4, A5, A6, B5, B6, Folio, 216 × 340 mm	Select from the Metric series standard sizes.

[Inch]

Value	Description
Letter, Legal, Statement, Executive, Oficio II	Select from the Inch series standard sizes.

[Others]

Value	Description
16K, Hagaki, Oufukuhagaki, Envelope Monarch, Envelope #10, Envelope #9, Envelope #6, Envelope DL, Envelope C5, ISO B5, Youkei 2, Youkei 4, Nagagata 3, Nagagata 4, Younaga 3	Select from special standard sizes.

Relationship between Original Size, Storing Size, and Zoom

Original Size, Storing Size, and Zoom are related to each other. For details, see the table below.

- Original Size and the size you wish to store as are the same

Original Size

Specify as necessary.

➔ [Original Size \(page 321\)](#)

Storing Size

Select [Same as Original Size].

Zoom (XY Zoom)

Select [100%] (or [Auto]).

➔ [Zoom \(page 347\)](#)

- Original Size and the size you wish to store as are different

Original Size

Specify as necessary.

➔ [Original Size \(page 321\)](#)

Storing Size

Select the desired size.

Zoom

Select [Auto].

➔ [Zoom \(page 347\)](#)

NOTE

When you select Storing Size that is different from Original Size, and select the Zoom [100%], you can store the image as the actual size (No Zoom).

Encrypted PDF Password



[Functions]

Enter the preassigned password to print the PDF data.

Enter the password, and select [OK].



NOTE

For details on entering the password, refer to the following:

➔ [Character Entry Method \(page 748\)](#)

JPEG/TIFF Print



Select the image size when printing JPEG or TIFF files.

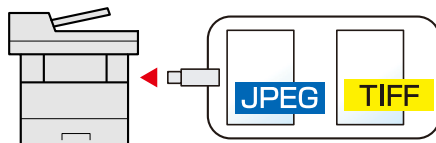

Item	Description
[Fit to Paper Size]	Fits the image size to the selected paper size.
[Image Resolution]	Prints at resolution of the actual image.
[Fit to Print Resolution]	Fits the image size to the print resolution.

XPS Fit to Page



[Functions]

Reduces or enlarges the image size to fit to the selected paper size when printing XPS file.

(Value: Off / On)

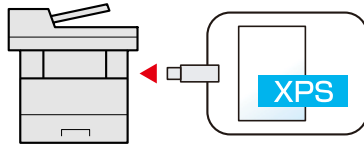

7 Status/Job Cancel

Checking Job Status

Check the status of jobs being processed or waiting to be printed.

Available Status Screens

The processing and waiting statuses of jobs are displayed as a list on the touch panel in four different screens - Printing Jobs, Sending Jobs, Storing Jobs, and Scheduled Jobs.

The following job statuses are available.

Status Screens	Job status to be displayed
Print Job Status	<ul style="list-style-type: none"> • Copy • Printer • Printing from Document Box • Fax reception • Email reception • Printing data from USB Drive • Application • Printing Report/List
Send Job Status	<ul style="list-style-type: none"> • Email • Sending Job Folder • Fax transmission • Sending Job - Fax Server • Sending Job Application • Multiple destination
Store Job Status	<ul style="list-style-type: none"> • Scan • Storing Job Fax • Storing Job Printer • Join Box Document • Copy Box Document
Scheduled Job	Sending Job FAX using Delayed transmission

Displaying Status Screens

1 Display the screen.

Select the [Status / Job Cancel] key.

2 Select the job you want to check.

Select the job to check from [Printing Jobs], [Sending Jobs], [Storing Jobs], [Scheduled].

Select [Sending Jobs] → [Scheduled] to check delayed transmission.

➔ [Print Jobs Screen \(page 399\)](#)

➔ [Send Jobs screen \(page 400\)](#)

➔ [Store Jobs screen \(page 402\)](#)

➔ [Scheduled Job Screen \(page 404\)](#)







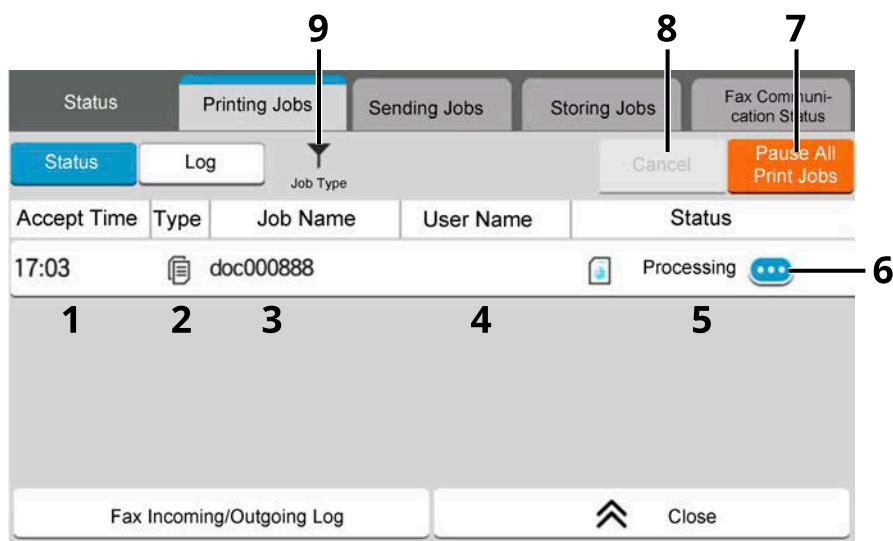

Details of the Status Screens

NOTE

- You can show the job statuses of all users, or only the statuses of your own jobs.
 - ➔ [Job Status/Job Logs Settings \(page 473\)](#)
- This setting can also be changed from Command Center RX. For details, refer to the following:
 - ➔ [Command Center RX User Guide](#)

Print Jobs Screen



- Accept Time
Accepted Time of job
- Type
Icons that indicate the job type
 -  Copy job
 -  Printer job
 -  Job from Document Box
 -  Fax reception
 -  Email reception
 -  Data from USB Drive
 -  Application
 -  Report/List
- Job Name
Job Name or file name

4 User Name

User Name for the executed job

5 Status

Status of job

[Processing]: The status before starting to print

[Printing]: Printing

[Waiting]: Print Waiting

[Pause]: Pausing print job or error

[Canceling]: Canceling the job

6  (information icon)

Select the icon of the job whose detailed information you want to display.

➔ [Checking Detailed Information of Jobs \(page 405\)](#)

7 [Pause AllPrint Jobs]

The current print job is temporarily interrupted. Select again to resume printing.

8 [Cancel]

Select the job you want to cancel from the list, and select this key.

9 [Job Type]

Only selected type of jobs is displayed.

 **NOTE**

The job name and user name can be changed to other items if needed.

➔ [Status \(page 473\)](#)

Send Jobs screen

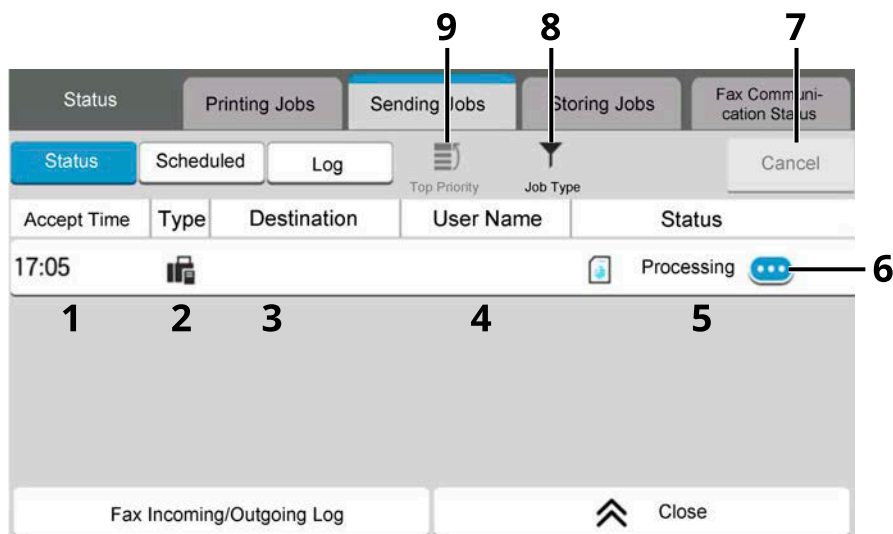

1 Accept Time

Accepted Time of job

2 Type

Icons that indicate the job type

 Sending Job Email

 Sending Job Folder

 Sending Job Fax

 Sending Job - Fax Server

 Sending Job Application

 Multi Sending

3 Destination

Destination (Either destination name, Fax number, Email address, or server name)

4 User Name

User Name for the executed job

5 Status

Status of job

[Processing]: The status before starting sending such as during scanning originals

[Sending]: Sending

[Waiting]: Waiting Sending

[Canceling]: Canceling the job

[Pause]: Pausing the job

6  (information icon)

Select the icon of the job whose detailed information you want to display.

➔ [Checking Detailed Information of Jobs \(page 405\)](#)

7 [Cancel]

Select the job you want to cancel from the list, and select this key.

8 [Job Type]

Only selected type of jobs is displayed.

9 [Top Priority]

Select the job to be overridden, and select this key. Only displayed when the optional fax kit is installed.





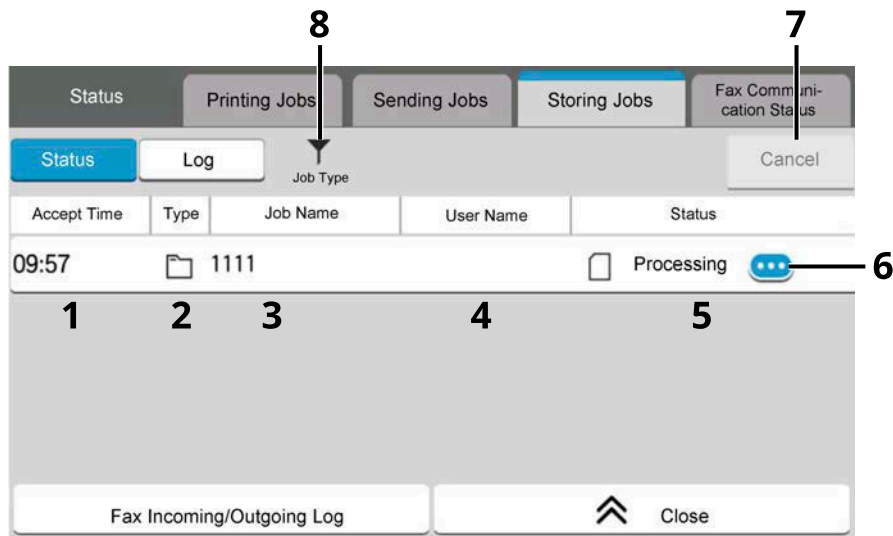

 **NOTE**

The address and user name can be changed to other items if needed.

➔ [Status \(page 473\)](#)

Store Jobs screen



- 1 Accepted Time
Accepted Time of job
- 2 Type
Icons that indicate the job type
 -  Storing Job Scan
 -  Storing Job Fax
 -  Storing Job Printer
 -  Join Box Document
 -  Copy Box Document
- 3 Job Name
Job name or file name is displayed
- 4 User Name
User Name for the executed job
- 5 Status
Status of job
 [Processing]: The status before starting to save, such as during scanning originals
 [Storing]: Storing data
 [Canceling]: Canceling the job
 [Pause]: Pausing the job
- 6  (information icon)
Select the icon of the job whose detailed information you want to display.
 ➔ [Checking Detailed Information of Jobs \(page 405\)](#)
- 7 [Cancel]
Select the job you want to cancel from the list, and select this key.

8 [Job Type]

Only selected type of jobs is displayed.



NOTE

The job name and user name can be changed to other items if needed.

➔ [Status \(page 473\)](#)

Scheduled Job Screen

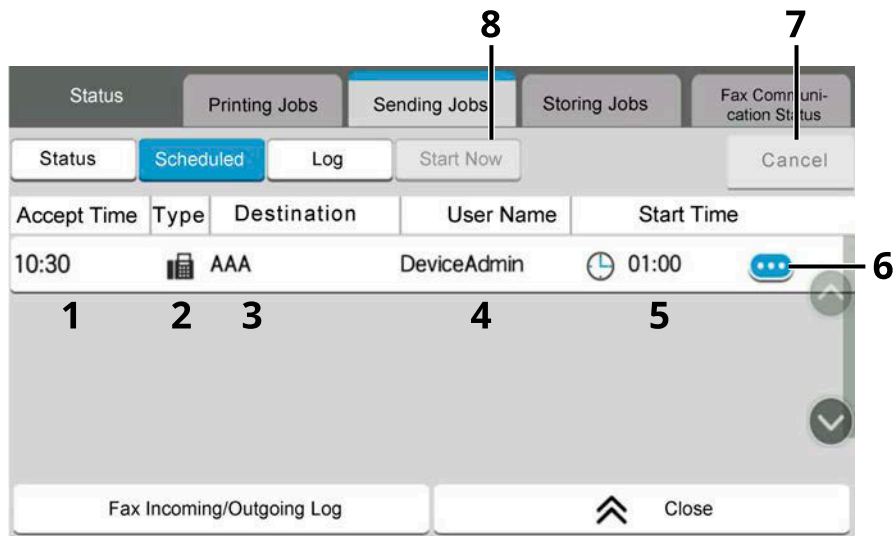

- 1 Accept Time
Accepted time of job
- 2 Type
Icons that indicate the job type
 - ☎ Scheduling Job Fax
- 3 Destination
Destination (Either destination name, FAX number, or No. of broadcast items)
- 4 User Name
User Name for the executed job
- 5 Start Time
Time to start the scheduled job
- 6 ⓘ (information icon)
Select the icon of the job whose detailed information you want to display.
 - ➔ [Checking Detailed Information of Jobs \(page 405\)](#)
- 7 [Cancel]
Select the job you want to cancel from the list, and select this key.
- 8 [Start Now]
Select the job you want to send immediately from the list, and select this key.

Checking Detailed Information of Jobs

1 Display the screen.



→ [Details of the Status Screens \(page 399\)](#)

2 Check the information.

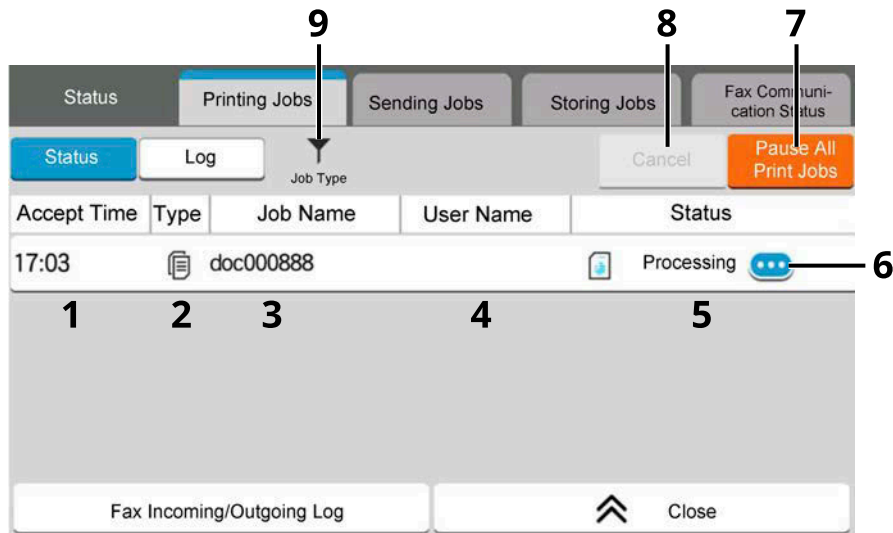
1 Select  (information icon) for the job for which you wish to display detailed information.



Detailed information of the selected job is displayed.

In Sending Jobs, you can check the destination by selecting  (information icon) in "Status/Destination". Select  (information icon) for the destination to display detailed information.

2 After checking, select [Close].

Checking Job History

 **NOTE**

- Job history is also available by Command Center RX or KYOCERA Net Viewer from the computer. For details, refer to the following:
 - ➔ **Command Center RX User Guide**
 - ➔ **KYOCERA Net Viewer User Guide**
- You can show the job log of all users, or only your own job log.
 - ➔ [Job Status/Job Logs Settings \(page 473\)](#)
- This setting can also be changed from Command Center RX. For details, refer to the following:
 - ➔ **Command Center RX User Guide**

Available Job History Screens

The job histories are displayed separately in three screens - Printing Jobs, Sending Jobs, and Storing Jobs. The following job histories are available.

Screen	Job histories to be displayed
Printing Jobs	<ul style="list-style-type: none"> • Copy • Printer • Print from Box • Fax reception • Email reception • Printing data from USB Drive • Application • Job Report/List
Sending Jobs	<ul style="list-style-type: none"> • Email • Sending Job Folder • Fax transmission • Sending Job - Fax Server • Sending Job - Application • Multi Sending
Storing Jobs	<ul style="list-style-type: none"> • Scan • Fax • Printer • Join Box Document • Copy Box Document

Displaying Job History Screen

1 Display the screen.

- 1 Select the [Status / Job Cancel] key.

2 Select the job you want to check.

- 1 Select [Log] and select the job you wish to check.











Checking the Detailed Information of Histories

1 Display the screen.

- [Displaying Job History Screen \(page 407\)](#)

2 Check the information.

- 1 Select  (information icon) for the job you want to check.

Status		Printing Jobs	Sending Jobs	Storing Jobs	Fax Communication Status
Status	Log	Job Type			
End Date	Type	Job Name	User Name	Result	
11/02 15:20		doc0000052021110 2151930			Error 
11/02 15:17		doc0000042021110 2151658			Completed 
11/02 11:12		doc0000022021110 2111201	DeviceAdmin		Completed 
11/02 11:06		doc0000012021110 2110551	DeviceAdmin		Completed 

Fax Incoming/Outgoing Log  Close

Detailed information of the selected job is displayed.

- 2 After checking, select [Close].

Sending the Log History

You can send the log history by E-mail. You can either send it manually as needed or have it sent automatically whenever a set number of jobs is reached.

- [Sending Log History \(page 447\)](#)

Job Operation

Pause and Resumption of Jobs

Pause/resume all printing jobs in printing/waiting.

1 Display the screen.

- 1 Select the [Status / Job Cancel] key.

2 Select [Pause AllPrint Jobs] on the printing jobs status screen.

Printing is paused.

When resuming the printing of jobs that have been paused, select [Resume AllPrint Jobs] .

Canceling of Jobs

A job in printing/waiting status can be canceled.

1 Display the screen.

- 1 Select the [Status / Job Cancel] keys.

2 Select the job to be canceled from the list, and select [Cancel].

3 Select [Yes] in the confirmation screen.

Device Information

Configure the devices/lines installed or connected to this machine or check their status.

1 Display the screen.

1 Select the [Home] key.

2 Select [DeviceInformation].

The screen to check the status or configure the devices is displayed.

2 Check the information.

The items you can check are described below.

[Identification/Wired Network]

You can check ID information such as the model name, serial number, host name and location, and the IP address of the wired network.

[Wi-Fi Direct/Wi-Fi]

You can check the status of Wi-Fi connection, such as the device name, network name and IP address.



NOTE

Displayed when the optional Wireless Network Interface Kit is installed.

[Supplies/Unit Condition]

You can check the presence of toner and paper, and the condition of the unit.

➔ [Checking the Remaining Amount of Toner and Paper, and the Condition of the Unit \(page 411\)](#)

[Fax]

You can check the local fax number, local fax name, local fax ID and other fax information. For details, refer to the following:

➔ **FAX Operation Guide**



NOTE

This item is displayed for fax-compatible machines.

[USB/Bluetooth]

You can check the connection status of USB drive and Bluetooth keyboard.

- Select "USB Drive" for [Format] if you wish to format external media.
-



IMPORTANT

When [Format] is selected, all data in the USB drive is erased.

- Select "USB Drive" for [Remove] to safely remove the external media.
- Select "Bluetooth" for [Connect] to establish the Bluetooth keyboard connection.

[Option/Application]

You can check information on the options and applications that are used.

[Capability/Version]

You can check the software version and performance.

[Security]

You can check the security information on the machine.

[Report]

You can print various reports and lists.

[Remote Ope.Status]

You can check the situation of remote operation.

Checking the Remaining Amount of Toner and Paper, and the Condition of the Unit

On the touch panel, you can check the presence of toner and paper, as well as the remaining life of the unit.

1 Display the screen.

- 1 Select the [Home] key.
- 2 Select [DeviceInformation].
- 3 Select [Supplies/Unit Condition].

2 Check the information.

The items you can check are described below.

Toner Information

The amount of toner remaining is shown in levels. And you can check the status of waste toner box.

Paper

You can check the size, orientation, type, and remaining amount of paper in each paper source. The amount of paper remaining is shown in levels.

Unit Condition

Displays the time remaining on the Developer Unit, the Document Processor, and the Cassette.

8 System Menu

Operation Method

Configure settings related to overall machine operation. Change the default settings as appropriate for how you use the machine.

1 Display the screen.

- 1 Select [System Menu / Counter].

2 Select a function.

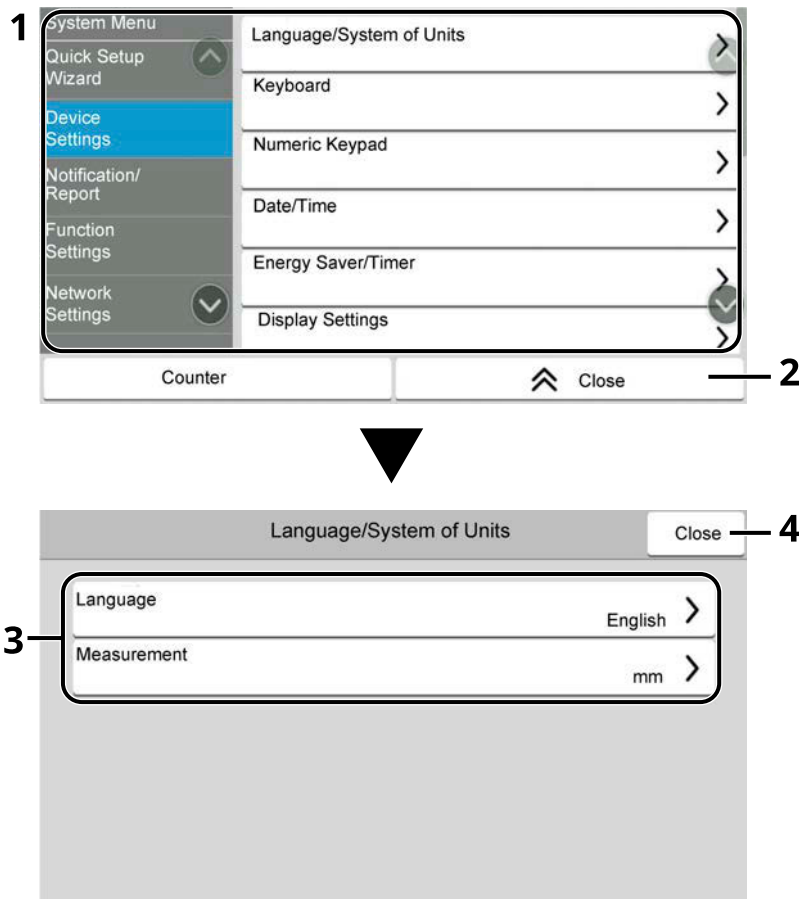

- 1 Displays the System Menu items. Items that are not displayed can be displayed by swiping the screen up and down.
- 2 Returns to the previous screen.
- 3 Displays setting items.
Select the key of a function to display the setting screen.
- 4 Returns to the previous screen.

3 Configure the function.

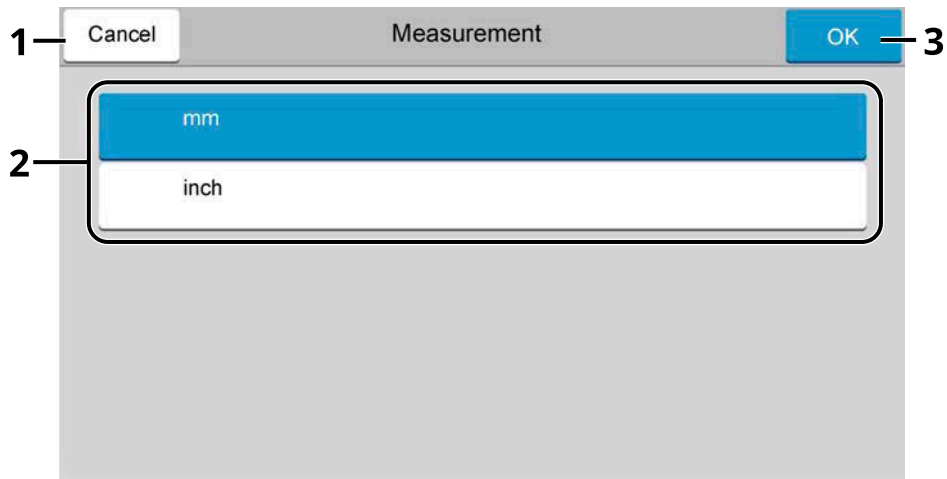

- 1 Returns to the previous screen without making any changes.
- 2 Enter a setting by selecting it and return to the previous screen.
- 3 Accepts the settings and exits.



NOTE

- If the user authentication screen appears, log in with a user who has the privilege to configure this setting. If you do not know your login user name or password, please contact your administrator.
 - If function default settings have been changed, the [Reset] key can be selected in each function screen to immediately change the settings.
-

System Menu Settings

This section explains the functions that can be configured in System Menu. To configure the settings, select the item in System Menu and select the setting item.

For details on each function, see the table below.

[Quick Setup Wizard]

The Quick Setup Wizard configures Fax, Energy Saver, Network, E-mail and Security Setup.

➔ [Quick Setup Wizard \(page 93\)](#)

[Device Settings]

Configure overall machine operation.

➔ [Device Settings \(page 420\)](#)

Item	Description
[Language/System of Units]	Set the language to use for the touch panel display, and select inch or metric for the unit for paper dimensions. ➔ Language/System of Units (page 420)
[Keyboard]	Change the layout of the touch panel keyboard used to enter characters. ➔ Keyboard (page 420)
[Numeric Keypad]	Select whether or not to display the numeric keypad. ➔ Numeric Keypad (page 420)
[Date/Time]	Configures settings related to the date and time. ➔ Date/Time (page 421)
[Energy Saver/Timer]	Configure the Energy Saver settings. ➔ Energy Saver/Timer (page 422)
[Display Settings]	Configure the touch panel display settings. ➔ Display Settings (page 425)
[Sound]	Set options for buzzer sound during the machine operations. ➔ Sound (page 427)
[Original/Scan Settings]	Configure settings for originals. ➔ Original/Scan Settings (page 428)
[Paper Feeding]	Configure the paper and paper source settings. ➔ Paper Feeding (page 430)
[Function Key Assignment]	Assign a function to each function key. ➔ Function Key Assignment (page 438)
[Operation Assist]	It is possible to configure the settings for the Orientation Selection screen display and the Preset Limit on the number of copies that can be made at one time. ➔ Operation Assist (page 439)

Item	Description
[Error Handling]	Select whether to cancel or continue the job when error has occurred. ➔ Error Handling (page 440)
[Toner Settings]	Configure the toner settings. ➔ Toner Settings (page 441)

[Notification/Report]

Print reports to check the machine settings, status, and history. Settings for printing reports can also be configured.

➔ [Notification/Report \(page 442\)](#)

Item	Description
Print Report/List	Print various reports and lists. ➔ Print Report/List (page 442)
Result Report Setting	Configure settings for notices for sending and receiving. ➔ Result Report Setting (page 445)
Device Status Notification	Configure settings for toner notices. ➔ Device Status Notification (page 446)
Fax Communication Report	Configure settings for Outgoing Fax report and Incoming Fax report. This item is displayed for fax-compatible machines. ➔ Fax Communication Report (page 446)
History Settings	Configure settings for printing the history of the machine use. ➔ History Settings (page 447)

[FunctionSettings]

Configures settings for copying, sending and Document Box functions.

➔ [FunctionSettings \(page 449\)](#)

Item	Description
[Function Defaults]	Defaults are the values automatically set after the warm-up is completed or the [Reset] key is selected. Set the defaults for available settings such as copying and sending. Setting the frequently-used values as defaults makes subsequent jobs easier. ➔ Function Defaults (page 449)
[Copy/Print]	Configures settings for copying and printing functions. ➔ Copy/Print (page 455)
[Send/Store]	Configures settings for sending and storing functions. ➔ Send/Store (page 455)
[Email]	Configure settings for email transmission and receipt. ➔ Email (page 457)

Item	Description
[Sending Job - Folder]	Configures settings for Sending Job Folder functions. ➔ Sending Job - Folder (page 459)
[Fax]	Configures settings for fax functions. This item is displayed for fax-compatible machines. ➔ FAX Operation Guide
[WSD]	Configure settings for WSD Scan and WSD Print. ➔ WSD (page 461)
[Address Book]	Configures Address Book settings. ➔ Address Book (page 462)
[One-Touch Key]	Configures One Touch Key settings. ➔ One-Touch Key (page 463)
[Send and Forward]	Select whether to forward the original to another destination when sending images. ➔ Send and Forward (page 464)
[Forward setting]	Configure the Forwarding settings. ➔ Forward setting (page 465)
[Printer]	Printing from computers, settings are generally made on the application software screen. However, the following settings are available for configuring the defaults to customize the machine. ➔ Printer (page 466)
[Document Box]	Configure settings for Custom Box. ➔ Document Box (page 470)
[Job Box]	Configure settings for Job Box. ➔ Job Box (page 471)
[Subaddress Box]	Configure settings for Subaddress Box. This item is displayed for fax-compatible machines. ➔ FAX Operation Guide
[Fax Memory RX Box]	Set whether to perform print immediately for the FAX documents received or to save them in the Fax Memory RX Box. This item is displayed for fax-compatible machines. ➔ FAX Operation Guide
[Home]	Configure settings for Home screen. ➔ Home screen (page 59)
[Status]	Configure settings for Status. ➔ Status (page 473)
[Remote Services]	Configures remote services settings. ➔ Remote Services (page 474)
[TWAIN/WIA]	Set whether to use our proprietary web services. ➔ TWAIN/WIA (page 475)

[NetworkSettings]

Configures network settings.

➔ [NetworkSettings \(page 476\)](#)

Item	Description
NetworkSettings	Configure the wired network and Wi-Fi settings. ➔ NetworkSettings (page 476)
Optional Network	Configure settings for the optional Network Interface Kit or Wireless Network Interface Kit. ➔ Optional Network (page 496)
Connectivity	Configure the Connectivity settings of this machine to other devices. ➔ Connectivity (page 499)
Others	Configure other network related settings. ➔ Others (page 500)

[SecuritySettings]

Configures security settings.

➔ [SecuritySettings \(page 501\)](#)

Item	Description
[Security Quick Setup]	The Security Level setting is primarily a menu option used by service personnel for maintenance work. There is no need for customers to use this menu. ➔ Security Quick Setup (page 501)
Interface Block Setting	This allows you to protect this machine by blocking the interface with external devices such as USB hosts or optional interfaces. ➔ Interface Block Setting (page 503)
Device Security Settings	Configures the device security settings. ➔ Device Security Settings (page 504)
Authentication Security	Configure security settings for User Authentication. ➔ Authentication Security (page 509)
Unknown User Settings	This specifies the behavior for handling the jobs sent with unknown or unsent login user names or User ID. ➔ Unknown User Settings (page 509)
Network	Configure security settings on the network. ➔ Network (page 510)

[Job Accounting/Authentication]

Configures settings related to machine management.

For details on user login administration, refer to the following:

➔ [Enable User Login Administration \(page 521\)](#)

For details on job accounting, refer to the following:

➔ [Enabling Job Accounting \(page 552\)](#)

[Add/DeleteApplication]

Configure settings for Application.

➔ [Add/DeleteApplication \(page 512\)](#)

Item	Description
Application	Configure settings for applications that help you perform your daily more efficiently such as a scan feature and an authentication feature. ➔ Using Applications (page 238)
Optional Function	You can use the optional applications installed on this machine. ➔ Overview of the Applications (page 746)

Adjustment/Maintenance

Adjust printing quality and conduct machine maintenance.

➔ [Adjustment/Maintenance \(page 513\)](#)

Item	Description
Image Adjustment	Perform Image Adjustment. ➔ Image Adjustment (page 513)
Others	Adjust Others. ➔ Others (page 516)

DeviceSettings

Configure overall machine operation.

Language/System of Units

[System Menu / Counter] key > [DeviceSettings] > [Language/System of Units]

Item	Description
[Language]	Set the language to use for the touch panel display.
[Measurement]	Select inch or metric for the unit for paper dimensions. Value: [mm], [inch]

Keyboard

[System Menu / Counter] key > [DeviceSettings] > [Keyboard]

Item	Description
[Keyboard Layout]	Change the layout of the touch panel keyboard used to enter characters. Value: [QWERTY], [QWERTZ], [AZERTY]
[Optional Keyboard Type]	Select the optional keyboard type. Value: [US-English], [US-English with Euro], [French], [German], [UK-English]

Numeric Keypad

[System Menu / Counter] key > [DeviceSettings] > [Numeric Keypad]

[Default Display]

Item	Description
[Copy/Print from Box]	Select whether or not to display the numeric keypad. Value: Off, On
[HyPAS Application]	

[Layout (HyPAS Application)]

Select the HyPAS numeric keypad layout to display upon startup.

Value: [Floating], [Horizontal], [On the Right]

Date/Time

[System Menu / Counter] key > [DeviceSettings] > [Date/Time]

Item	Description
[Date and Time]	<p>Set the date and time for the location where you use the machine. If you perform Send as Email, the date and time set here will be displayed on the header.</p> <p>Value: [Year (2000 - 2035)] (2000 to 2035), [Month (1 - 12)] (1 to 12), [Day (1 - 31)] (1 to 31), [Hour (0 - 23)] (0 to 23), [Min. (0 - 59)] (0 to 59), [Second (0 - 59)] (0 to 59)</p> <p>➔ Setting Date and Time (page 78)</p> <hr/> <p> NOTE</p> <p>If you change the date/time while using the trial version of an application, you will no longer be able to use the application.</p>
[Date Format]	<p>Select the display format of year, month, and date. The year is displayed in Western notation.</p> <p>Value: [MM/DD/YYYY], [DD/MM/YYYY], [YYYY/MM/DD]</p>
[Time Zone]	<p>Set the time difference from GMT. Choose the nearest listed location from the list.</p> <p>If you select a region that utilizes summer time, configure settings for summer time.</p> <p>➔ Setting Date and Time (page 78)</p>

Energy Saver/Timer

[System Menu / Counter] key > [DeviceSettings] > [Energy Saver/Timer]

[Auto Panel Reset]

If no jobs are run for a certain period of time, automatically reset settings and return to the default setting. Select to use Auto Panel Reset or not.

Value: Off, On

NOTE

For setting the time until the panel is automatically reset, refer to the following:

➔ [Panel Reset Timer \(page 422\)](#)

[Panel Reset Timer]

If you select On for Auto Panel Reset, you can set the amount of time to wait before Auto Panel Reset.

Value: 5 to 495 seconds (in 5 second increments)

NOTE

This function is displayed when [Auto Panel Reset] is set to On.

[Sleep Timer]

Set amount of time before entering Sleep.

Value: 1 to 120 minutes (1 minute increments)

➔ [Sleep \(page 91\)](#)

[Sleep Rules]

Select whether to use the Sleep mode for the following functions individually:

This function will not be displayed when the optional Network Interface Kit or Fiery controller is installed.

- ID Card Reader
(Displayed when the optional Card Authentication Kit is activated.)
- Application

Value: Off, On



NOTE

If the sleep condition is not turned off, the ID card cannot be recognized.

[Sleep Level]

You can set the sleep level.

This function will not be displayed when the optional Network Interface Kit or Fiery controller is installed.

Item	Description
[Quick Recovery]	Set the Energy Saver mode to reduce power consumption even more than normal Sleep mode. <hr/>  NOTE Use the Quick Recovery mode only when the computer does not recognize USB-connected devices. Note that this will consume more power. <hr/>
[Energy Saver]	
[Sleep Rules]	Select whether to use the Energy Saver mode for the following functions individually: <ul style="list-style-type: none"> • ID Card Reader Displayed when the optional Card Authentication Kit is activated. • Application Value: Off, On <hr/>  NOTE When the machine has entered sleep mode with Energy Saver setting, the ID card cannot be recognized. <hr/>

[Weekly Timer Settings]

Configure settings for switching the machine into Sleep mode and waking it automatically at a specified time for each day of the week.

Item	Description
[Weekly Timer]	Select whether to use Weekly Timer. Value: Off, On
[Schedule]	Specify the time for each day of the week at which the machine enters Sleep mode and recovers.
[Retry]	Set the number of retry to switch the machine into Sleep mode. Value: [Not Retry], [Limited Retries], [Unlimited Retries] <hr/>  NOTE <ul style="list-style-type: none"> • If [Limited Retries] is selected, set the number of retries. The setting range is 0 to 10. • If [Unlimited Retries] is selected, retry is performed until the machine enters Sleep mode. <hr/>
[Retry Interval]	Set the retry interval. Use [-] / [+] to enter a number. Value: 10 to 60 seconds (in 10 second increments)

[Energy Saver Recovery Level]

Select the method of recovery from energy saver.

Value

[Full Recovery]

This mode enables the use of all functions immediately. However, this mode saves less energy.

[Normal Recovery]

In this mode, you can select the method from the following: enabling the use of all functions immediately or enabling the use of desired functions only. If you want to use all functions immediately, select the [Energy Saver] key to execute recovery.

[Power Saving Recovery]

This mode enables the use of the functions that you wish to use only. This is the most energy-efficient mode.

[Ping Timeout]

Set the time until timeout occurs when [Ping] is executed in "NetworkSettings".

Value: 1 to 30 seconds (in 1 second increments)

Display Settings

[System Menu / Counter] key > [DeviceSettings] > [Display Settings]

Item	Description
[Display Brightness]	Set the brightness of the touch panel. Value: 1 (Darker), 2, 3, 4, 5 (Lighter)
[Default Screen]	Select the screen appearing right after start-up (default screen). Value: [Home], [Copy], [Send], [Fax] ^{*1} , [Status], [Custom Box], [Job Box], [USB Drive], [Polling Box] ^{*1} , [Subaddress Box] ^{*1} , [Fax MemoryRXBox] ^{*1} , [Favorites], [Home (Accessibility)], [Accessibility Copy], [Accessibility Send], [Accessibility Fax] ^{*1} , Application Name ^{*2}
[Wallpaper]	➔ Editing the Home Screen (page 61)
[Show Power Off Message]	Set the mode whether display a confirmation message in power supply off. Value: Off, On
[Quick Setup Registration (Copy)]	Select the functions to be registered for Quick Setup. Six keys of the Quick Setup screen are allocated to typical functions but can be changed as necessary. Six items in the following options are available. Value: [Off], [Paper Selection], [Zoom], [Density], [Duplex], [Combine], [Collate], [Original Image], [Original Size], [Original Orientation], [Color Selection], [Continuous Scan], [Background Density Adj.], [Quiet Mode]
[Quick Setup Registration (Send)]	Select the functions to be registered for Quick Setup. Six keys of the Quick Setup screen are allocated to typical functions but can be changed as necessary. Six items in the following options are available. Value: [Off], [Original Size], [Duplex], [Sending Size], [Original Orientation], [File Format], [Density], [Original Image], [Scan Resolution], [Fax TX Resolution] ^{*1} , [Color Selection], [Zoom], [Continuous Scan], [Background Density Adj.], [Quiet Mode]
[Quick Setup Registration (Fax)] ^{*1}	➔ FAX Operation Guide
[Quick Setup Registration (Storing in Box)]	Select the functions to be registered for Quick Setup. Six keys of the Quick Setup screen are allocated to typical functions but can be changed as necessary. Six items in the following options are available. Value: [Off], [Color Selection], [Storing Size], [Density], [Duplex], [Scan Resolution], [Zoom], [Original Orientation], [Original Size], [Original Image], [Continuous Scan], [Background Density Adj.]
[Quick Setup Registration (Box Print)]	Select the functions to be registered for Quick Setup. Six keys of the Quick Setup screen are allocated to typical functions but can be changed as necessary. Six items in the following options are available. Value: [Off], [Paper Selection], [Collate], [Duplex], [Delete after Printed], [Color Selection], [Quiet Mode]

Item	Description
[Quick Setup Registration (Sending from Box)]	Select the functions to be registered for Quick Setup. Six keys of the Quick Setup screen are allocated to typical functions but can be changed as necessary. Six items in the following options are available. Value: [Off], [Fax TX Resolution] ^{*1} , [File Format], [Delete after Transmitted]

*1 This item is displayed for fax-compatible machines.

*2 The running application will be displayed.

➔ [Using Applications \(page 238\)](#)

Sound

[System Menu / Counter] key > [DeviceSettings] > [Sound]

[Buzzer]

Set options for buzzer sound during the machine operations.

Item	Description
[Volume]	Set the buzzer volume level. Value: 0 (Mute), 1 (Minimum), 2, 3 (Medium), 4, 5 (Maximum)
[Key Confirmation]	Emit a sound when the operation panel and touch panel keys are selected. Value: Off, On
[Job Finish]	Emit a sound when a print job is normally completed. Value: Off, On, [Fax Reception Only] ^{*1}
[Ready]	Emit a sound when the warm-up is completed. Value: Off, On
[Warning]	Emit a sound when errors occur. Value: Off, On
[Optional Keyboard]	Emit a sound to confirm key presses with a sound. Value: Off, On

*1 This item is displayed for fax-compatible machines.

[Fax Speaker Volume]

This item is displayed for fax-compatible machines.

For details, refer to the following:

➔ **FAX Operation Guide**

[Fax Monitor Volume]

This item is displayed for fax-compatible machines.

For details, refer to the following:

➔ **FAX Operation Guide**

Original/Scan Settings

[System Menu / Counter] key > [DeviceSettings] > [Original/Scan Settings]

[Auto Detect Original Size]

Set whether to use the document processor to detect the original size. Platen cannot automatically detect the original size.

Item	Description
[Auto (Standard Size)]	Select whether to enable automatic detection of the Standard Size. The size that can be detected is A6, B6, A5, B5, A4, and Folio in the case of centimeter size. For inch size, Statement, Letter, and only one of Legal, Oficio II, or 216mm x 340mm. Value: Off, On
[Detect Non-standard Size (Copy)]	Set whether to detect non-standard size documents in the copy function. This setting takes precedence over the automatic (standard size) setting. Value: [Off], [On]
[Detect Non-standard Size (Send/Store)]	Set whether to detect non-standard size documents in the send or save function. This setting takes precedence over the automatic (standard size) setting. Value: [Off], [On]
[System of Units]	Select [Metric]Metric when automatically detecting the originals in centimeter sizes. Select [Inch] when detecting the originals in inch sizes. Value: [Metric], [Inch]
[Legal/OficioII/216 x 340 mm]	Since the third item options to be auto detected in inch are similar in size, set which size to use. This function is displayed when "System of Units" is set to [Inch]. Value: [Legal], [OficioII], [216 x 340 mm]

[Custom Original Size]

Set up frequently-used custom original size. The custom size option is displayed on the screen to select original size.

Value

Metric

X: 50 to 356 mm (in 1 mm increments)

Y: 50 to 216 mm (in 1 mm increments)

Inch

X: 1.97 to 14.02" (in 0.01" increments)

Y: 1.97 to 8.50" (in 0.01" increments)

X=Length, Y=Width

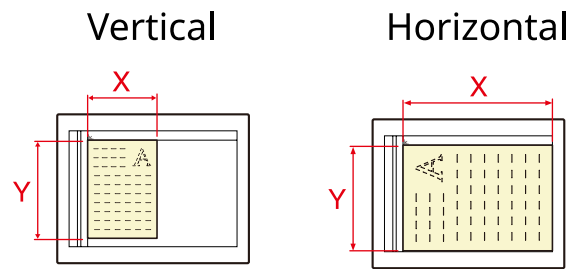

[Default Original Size]

Set the default value for the original size.

Value

[A/B]: A4, A5, A6, B5, B6, Folio, 216 x 340 mm

[Inch]: Letter, Legal, Statement, Executive, Oficio II

[Others]: 16K, ISO B5, Envelope #10, Envelope #9, Envelope #6, Envelope Monarch, Envelope DL, Envelope C5, Hagaki (Cardstock), Oufuku Hagaki (Return postcard), Youkei 4, Youkei 2, Younaga 3, Nagagata 3, Nagagata 4

[Default Original Size (Platen)]

Set the default value for the Original Size set on the Platen. Select [Off] to display a confirmation screen before execution of a job.

Value

[Metric]: A4, A5, A6, B5, B6, Folio, 216 x 340 mm

[Inch]: Letter, Legal, Statement, Executive, Oficio II

[Others] 16K, ISO B5, Envelope #10, Envelope #9, Envelope #6, Envelope Monarch, Envelope DL, Envelope C5, Hagaki (Cardstock), Oufuku Hagaki (Return postcard), Youkei 4, Youkei 2, Younaga 3, Nagagata 3, Nagagata 4

NOTE

When [Auto (Standard Size)] of [Auto Detect Original Size] is set to Off, this function will not be displayed.

Paper Feeding

[System Menu / Counter] key > [DeviceSettings] > [Paper Feeding]

Configure the paper and paper source settings.

[Cassette 1 Settings] to [Cassette 5 Settings]

[System Menu / Counter] key > [DeviceSettings] > [Paper Feeding] > [Cassette 1 Settings](to [Cassette 5 Settings])

NOTE

[Cassette 2] to [Cassette 5] are displayed when the following optional paper feeder is installed.

[Cassette 2]: Paper Feeder (550-sheet)

[Cassette 3]: Paper Feeder (550-sheet)

[Cassette 4]: Paper Feeder (550-sheet)

[Cassette 5]: Paper Feeder (550-sheet)

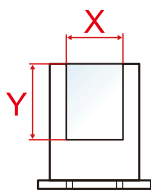
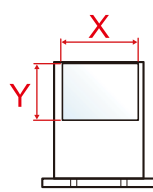
Item	Description
[Paper Size]	<p>Select the paper size. Set only when the size dial of the cassette is aligned with "Other".</p> <p>Value (Cassette 1) [A4], [A5-R], [A5], [A6], [B5], [B6], [Folio], [216 x 340 mm], [Letter], [Legal], [Statement-R], [Statement], [Executive], [OficioII], [16K], [ISO B5], [Custom]</p> <p>Value (Cassettes 2 to 5) [A4], [A5-R], [B5], [B6], [Folio], [216 x 340 mm], [Letter], [Legal], [Statement-R], [Executive], [OficioII], [16K], [ISO B5], [Envelope #10], [Envelope #9], [Envelope #6], [Envelope Monarch], [Envelope DL], [Envelope C5], [Youkei 2], [Youkei 4], [Nagagata 3], [Nagagata 4], [Younaga 3], [Custom]</p> <p>For custom paper size, set the size for each cassette.</p> <p>➔ [Custom Paper Settings] (page 432)</p> <div style="display: flex; justify-content: space-around; align-items: center;"> <div style="text-align: center;"> <p>Vertical</p>  </div> <div style="text-align: center;"> <p>Horizontal</p>  </div> </div>

Item	Description
[Media Type]	<p>Value (Cassette 1) [Plain], [Transparency], [Rough],[Vellum], [Recycled], [Preprinted], [Bond], [Color], [Prepunched], [Letterhead], [Thick], [High Quality], [Custom 1] to [Custom 8]</p> <p>Value (Cassettes 2 to 5) [Plain], [Rough],[Vellum], [Labels], [Recycled], [Preprinted], [Bond], [Color], [Prepunched], [Letterhead], [Envelope], [Thick], [Coated], [High Quality], [Custom 1] to [Custom 8]</p> <ul style="list-style-type: none"> • To change to a media type other than "Plain," refer to the following" <ul style="list-style-type: none"> ➔ [Media Type Setting] (page 434) • When a paper weight that cannot be loaded in the cassette is set for a media type, that media type does not appear. • To print on preprinted or prepunched paper or on letterhead, refer to the following: <ul style="list-style-type: none"> ➔ [Paper Feed Settings] (page 436)

[MP Tray Settings]

[Home] key > [...] > [System Menu] > [DeviceSettings] > [Paper Feeding] > [MP Tray Settings]

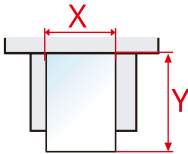
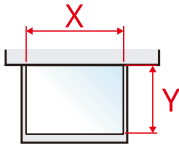
Item	Description
[Paper Size]	<p>Select the paper size.</p> <p>Value: [A4], [A5], [A5-R], [A6], [B5], [B6], [Folio], [216 x 340 mm], [Letter], [Legal], [Statement], [Statement-R], [Executive], [OficioII], [16K], [ISO B5], [Envelope #10], [Envelope #9], [Envelope #6], [Envelope Monarch], [Envelope DL], [Envelope C5], [Hagaki], [Oufukuhagaki], [Youkei 4], [Youkei 2], [Younaga 3], [Nagagata 3], [Nagagata 4], [Custom]</p> <p>For custom paper size, set the size for each cassette.</p> <p>➔ [Custom Paper Settings] (page 432)</p> <div style="display: flex; justify-content: space-around; align-items: center;"> <div style="text-align: center;"> <p>Vertical</p>  </div> <div style="text-align: center;"> <p>Horizontal</p>  </div> </div>
[Media Type]	<p>Select the media type.</p> <p>Value: [Plain], [Rough],[Vellum], [Labels], [Recycled], [Preprinted], [Bond], [Hagaki], [Color], [Prepunched], [Letterhead], [Envelope], [Thick], [Coated], [High Quality], [Custom 1] to [Custom 8]</p> <p>To change to a media type other than "Plain," refer to the following.</p> <p>➔ [Media Type Setting] (page 434)</p> <p>To print on preprinted or prepunched paper or on letterhead, refer to the following:</p> <p>➔ [Paper Feed Settings] (page 436)</p>

NOTE

The available media types for printing received faxes are as shown below.

[Plain], [Labels], [Bond], [Recycled], [Vellum], [Color], [Envelope], [Hagaki], [Coated], [Thick], [High Quality], [Custom 1] to [Custom 8]

The fax function can be used on products equipped with fax capability.

[Custom Paper Settings]

[System Menu / Counter] key > [DeviceSettings] > [Paper Feeding] > [Custom Paper Settings]

Set up frequently-used custom paper size. Register one custom size for each paper source. The registered size is displayed when the paper size is selected.

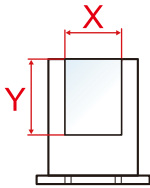
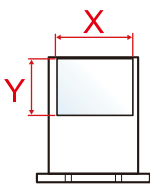
Item	Description
[Cassette 1 Size]* ¹	<p>Register the custom size used for cassette 1. Value</p> <p>Metric X: 105 to 216 mm (in 1 mm increments) Y: 140 to 356 mm (in 1 mm increments)</p> <p>Inch X: 4.13 to 8.50" (in 0.01" increments) Y: 5.50 to 14.02" (in 0.01" increments)</p> <p>X=Length, Y=Width</p> <div style="display: flex; justify-content: space-around; align-items: center;"> <div style="text-align: center;"> <p>Vertical</p>  </div> <div style="text-align: center;"> <p>Horizontal</p>  </div> </div>
[Cassette 2 Size]to [Cassette 5 Size]* ¹	<p>Register the custom size used for Cassette 2 to 5. Value</p> <p>Metric X: 92 to 216 mm (in 1 mm increments) Y: 162 to 356 mm (in 1 mm increments)</p> <p>Inch X: 3.62 to 8.50" (in 0.01" increments) Y: 6.38 to 14.02" (in 0.01" increments)</p> <p>X=Length, Y=Width</p>

Item	Description
[Multipurpose Tray Size]	<p>Register the custom size used for Multipurpose Tray. Value</p> <p>Metric X: 70 to 216 mm (in 1 mm increments) Y: 140 to 356 mm (in 1 mm increments)</p> <p>Inch X: 2.76 to 8.50" (in 0.01" increments) Y: 5.50 to 14.02" (in 0.01" increments)</p> <p>X=Length, Y=Width</p> <p style="text-align: center;">Vertical Horizontal</p>  <p>The diagrams illustrate two tray orientations. The 'Vertical' diagram shows a tray with a light blue center and a grey border. A red dimension line labeled 'X' indicates the width of the tray, and another red dimension line labeled 'Y' indicates the height. The 'Horizontal' diagram shows a similar tray, but the red dimension line labeled 'X' indicates the length (width of the tray), and the red dimension line labeled 'Y' indicates the height.</p>

*1 Used when the size dial of the cassette is set to "Other".

[Media Type Setting]

[System Menu / Counter] key > [DeviceSettings] > [Paper Feeding] > [Media Type Setting]

Select weight for each media type.

The following media type and paper weight combinations are available.

Paper Weight	Weight (g/m ²) and Media Type
Light	52 g/m ² to 59 g/m ²
Normal 1	60 g/m ² to 74 g/m ²
Normal 2	75 g/m ² to 90 g/m ²
Normal 3	91 g/m ² to 105 g/m ²
Heavy 1 ^{*1}	106 g/m ² to 135 g/m ²
Heavy 2 ^{*1}	136 g/m ² to 163 g/m ²
Heavy 3 ^{*1}	164 g/m ² to 220 g/m ²
Extra Heavy ^{*1}	Transparencies

*1 The processing speed will be slower than normal.

Each media type's default weight is indicated.

Media Type	Default
[Plain]	[Normal 1 (60 - 74g/m2)]
[Vellum]	[Normal 1 (60 - 74g/m2)]
[Labels]	[Heavy 1 (106 - 135g/m2)]
[Recycled]	[Normal 1 (60 - 74g/m2)]
[Preprinted]	[Normal 2 (75 - 90g/m2)]
[Bond]	[Normal 3 (91 - 105g/m2)]
[Cardstock]	[Heavy 3 (164 - 220g/m2)]
[Color]	[Normal 1 (60 - 74g/m2)]
[Prepunched]	[Normal 1 (60 - 74g/m2)]
[Letterhead]	[Normal 2 (75 - 90g/m2)]
[Envelope]	[Heavy 2 (136 - 163g/m2)]
[Thick]	[Heavy 2 (136 - 163g/m2)]
[Coated]	[Normal 3 (91 - 105g/m2)]
[High Quality]	[Normal 1 (60 - 74g/m2)]
[Custom 1] to [Custom 8]	[Normal 1 (60 - 74g/m2)]

For [Custom 1] to [Custom 8], settings for duplex printing and media type name can be changed.

[Duplex]

Item	Description
[Permit]	Duplex printing allowed.
[Prohibit]	Duplex printing not allowed.

[Name]

Change names for Custom 1-8. Names should be not more than 16 characters. Selecting media type at multipurpose tray, the name after change will be displayed.

→ [Character Entry Method \(page 748\)](#)

[Show Paper Setup Message]

[System Menu / Counter] key > [DeviceSettings] > [Paper Feeding] > [Show Paper Setup Message]

Set whether to display the confirmation screen for the paper setting when a new paper is set for each cassette.

Item	Description
[Cassette 1]to [Cassette 5]	Value: Off, On
[MP Tray]	 NOTE [Cassette 2] to [Cassette 5] are displayed when the following optional paper feeder is installed. [Cassette 2]: Paper Feeder (550-sheet) [Cassette 3]: Paper Feeder (550-sheet) [Cassette 4]: Paper Feeder (550-sheet) [Cassette 5]: Paper Feeder (550-sheet)

[Paper Feed Settings]

[System Menu / Counter] key > [DeviceSettings] > [Paper Feeding] > [Paper Feed Settings]

[Default Paper Source]

Select the default paper source.

Value: [Cassette 1] to [Cassette 5], [MP Tray]

NOTE

[Cassette 2] to [Cassette 5] are displayed when the following optional paper feeder is installed.

[Cassette 2]: Paper Feeder (550-sheet)

[Cassette 3]: Paper Feeder (550-sheet)

[Cassette 4]: Paper Feeder (550-sheet)

[Cassette 5]: Paper Feeder (550-sheet)

[Paper Selection]

Set the default paper selection.

Value: [Auto], [Default Paper Source]

[Auto Paper Selection]

If [Auto] is selected for Paper Selection, set the paper size selection method for when the zoom changes.

Value

[Most Suitable Size]: Selects optimum paper size based on the current zoom level and the size of the original.

[Same as Original Size]: Selects paper that matches the size of the original, regardless of the zoom level.

[Media for Auto (Color)]/[Media for Auto (B & W)]

When Auto is selected for Paper Selection, you can limit the paper that is automatically selected by paper type. For example, if [Plain] is selected, the paper source with plain paper loaded in the specified size is selected. Select [All Media Types] for the paper source with any kind of paper loaded in the specified size.

[All Media Types], [Plain], [Transparency], [Vellum], [Labels], [Recycled], [Preprinted], [Bond], [Cardstock], [Color], [Prepunched], [Letterhead], [Envelope], [Thick], [Coated], [High Quality], [Custom 1] to [Custom 8]

[Special Paper Action]

When printing on Prepunched, Preprint, and Letterhead, punch-holes might not be aligned or the print direction might be upside-down due to a combination of copying functions and the way originals are set. In such a case, select [Adjust Print Direction] to adjust the print direction. When paper orientation is not important, select [Speed Priority].

If [Adjust Print Direction] is selected, load paper according to the steps below.

Example: copying on Letterhead

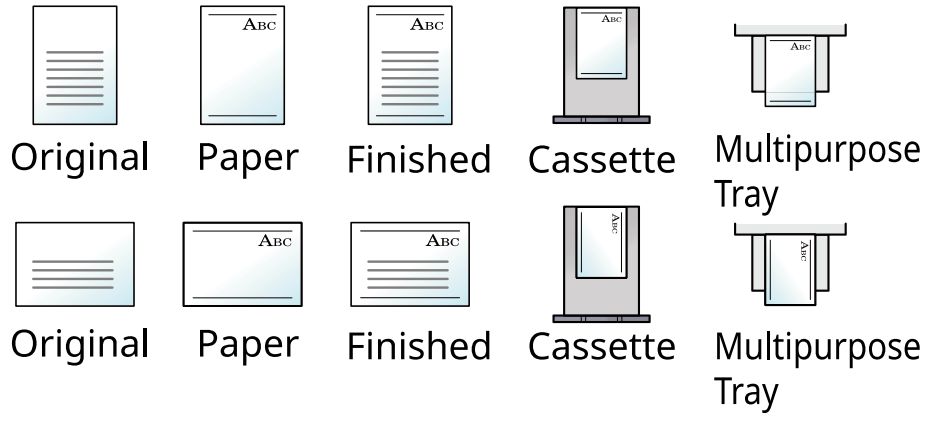

Value: [Adjust Print Direction], [Speed Priority]

Function Key Assignment

[System Menu / Counter] key > [DeviceSettings] > [Function Key Assignment]

Item	Description
[Function Key 1]	Assign a function to each function key.
[Function Key 2]	Value: [None], [Copy], [Send], [Fax Server] ^{*1} , [Fax] ^{*2} , [Custom Box] ^{*3} ,
[Function Key 3]	[Job Box], [USB Drive], [Subaddress Box] ^{*2} , [Polling Box] ^{*2} , [Fax MemoryRXBox] ^{*2} , [Send to Me (Email)] ^{*4} , [Send from Box (Email)] ^{*3*4} , Favorites ^{*5} , Application ^{*6} <hr/>  NOTE Select [Filter] to narrow down for [All], [Application], [Favorites] and [Others]. <hr/>

*1 This is displayed when the external server (Fax Server) is set.

*2 This item is displayed for fax-compatible machines.

*3 Displayed when the optional SSD is installed.

*4 Displayed when user login administration is enabled.

*5 The registered favorite will be displayed.

*6 The running application will be displayed.



Operation Assist

[System Menu / Counter] key > [DeviceSettings] > [Operation Assist]

Item	Description
[Orientation Confirmation]	Select whether to display a screen for selecting the orientation of the originals to be placed on the platen when using the following functions. ➔ Original Orientation (page 328) <ul style="list-style-type: none"> • Zoom • Duplex • Border Erase, Border Erase/Full Scan • Combine • Duplex Value: Off, On
[Preset Limit]	Restrict the number of copies that can be made at one time. Value: 1 to 999 copies
[Clear Settings after Job Started]	Set whether to reset function settings to their defaults after the job starts. Value: [Clear], [Do Not Clear]

Error Handling

[System Menu / Counter] key > [DeviceSettings] > [Error Handling]

Item	Description
[Duplexing Error]	<p>Set what to do when duplex printing is not possible for the selected paper sizes and media types.</p> <p>Value [1-sided]: Printed in 1-sided. [Display Error]: Message to cancel printing is displayed.</p>
[Paper Mismatch Error]	<p>Set what to do when the selected paper size or type does not match paper size or type loaded in the specified paper source while printing from the computer by specifying the cassette or multipurpose tray.</p> <p>Value [Ignore]: The setting is ignored and the job is printed. [Display Error]: Message to cancel printing is displayed.</p>
[Wrong Size Paper Loaded]	<p>Set what to do when it is detected that the multipurpose tray paper size setting does not match the actual paper size that is fed.</p> <p>Value : The setting is ignored and the job is printed. [Display Error]: Message to cancel printing is displayed.</p>
[Auto Error Clear]	<p>If an error occurs during processing, processing stops to wait for the next step to be taken by the user. In the Auto Error Clear mode, automatically clear the error after a set amount of time elapses.</p> <p>Value: On, Off</p> <hr/> <p> NOTE</p> <p>If you select On for Auto Error Clear, set the amount of time to wait before automatically clearing errors. The setting range is 5 to 495 seconds (in 5 second increments).</p> <hr/>
[Continue or Cancel Error Job]	<p>Set which users can cancel or continue operations for jobs which were paused due to an error.</p> <p>Value: [All Users], [Job Owner Only]</p> <hr/> <p> NOTE</p> <p>Administrator can cancel all jobs regardless of this setting.</p> <hr/>

Toner Settings

[System Menu / Counter] key > [DeviceSettings] > [Toner Settings]

[Color Toner Empty Action]

Select whether printing is prohibited or the Print in Black and White setting is used for printing once the color toner runs out.

Value: [Stop Printing], [Print in Black & White]

NOTE

This setting is enabled when original consumables (specified toner) are used.

[Low Toner Alert]



Item	Description
[Notify via Operation Panel]	Set whether to display the alert on the operation panel when the toner is low. Value: [Off], [On]
[Low Toner Alert Level]	Set the amount of remaining toner to notify the administrator when to order a toner when the toner is running low. This notification is used for Event Reports, Status Monitors, and SNMPTraps (such as Printing Equipment Management Systems). Value: Off, On  NOTE If On is selected, set the amount of remaining toner to alert. The setting range is 5 to 100% (in 1% increments).

Notification/Report

Print various reports to check the machine settings, status, and history. Settings for printing reports can also be configured.

Print Report/List

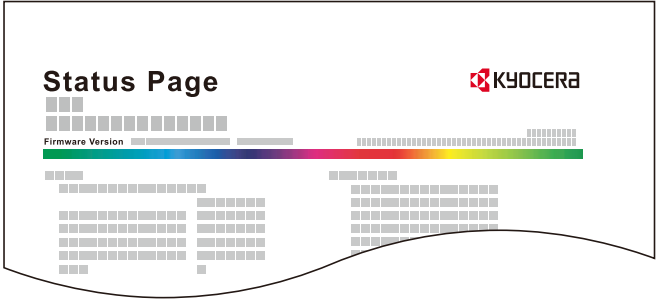
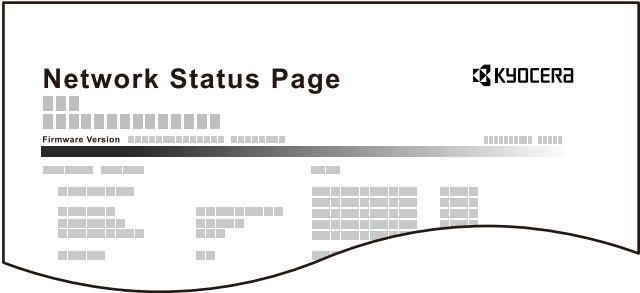
[System Menu / Counter] key > [Notification/Report] > "Print Report/List" [Print Report/List]

Item	Description
[Status Page]	<p>Prints the status page. You can check information such as the current settings, available memory, and installed optional equipments.</p> 
[Service Status]	<p>Prints the service status. More detailed information is available than on the Status Page. Service personnel usually print the service status pages for maintenance purpose.</p>
[Network Status]	<p>Prints the Network status page. You can check information such as the firmware version, network address, and network protocol of the network interface.</p> 
[Optional Network Status]	<p>Prints the Optional Network status page. You can check information such as the firmware version, network address, and network protocol of the optional network interface.</p> <hr/> <p> NOTE</p> <p>This function is displayed when the optional Network Interface Kit or Wireless Network Interface Kit is installed.</p> <hr/>

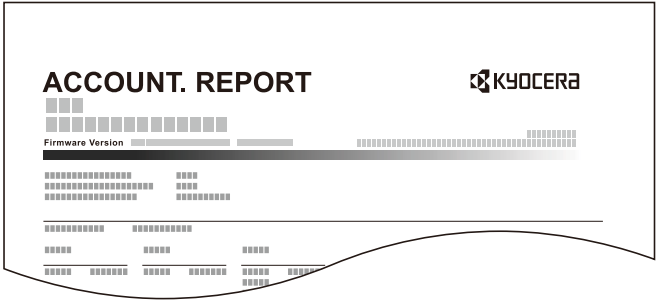
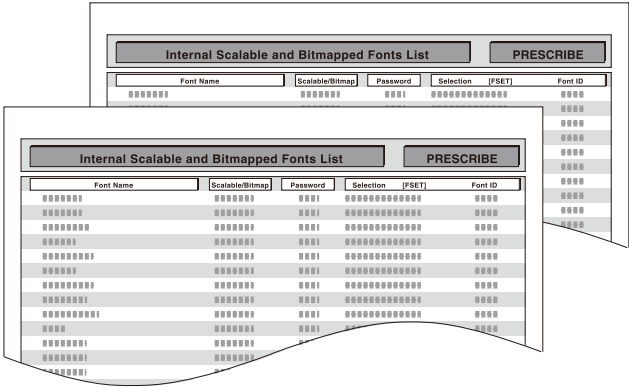
Item	Description
[Print Accounting Report]	<p>If job accounting is enabled, the total pages counted of all relevant accounts can be printed as an accounting report.</p>  <p>➔ Print Accounting Report (page 568)</p>
[Font List]	<p>Prints the font list. You can check the fonts installed in this machine with a sample.</p> 
[Outgoing Fax Report]	<p>This item is displayed for fax-compatible machines.</p> <p>➔ FAX Operation Guide</p>
[Incoming Fax Report]	<p>This item is displayed for fax-compatible machines.</p> <p>➔ FAX Operation Guide</p>
[Fax List (Index)]	<p>This item is displayed for fax-compatible machines.</p> <p>➔ FAX Operation Guide</p>
[Fax List (No.)]	<p>This item is displayed for fax-compatible machines.</p> <p>➔ FAX Operation Guide</p>
[One-Touch List (All)]	<p>Prints One Touch List, allowing you to check the destinations that have been registered on the One Touch Keys.</p>
[One-Touch List (Fax)]	<p>This item is displayed for fax-compatible machines.</p> <p>➔ FAX Operation Guide</p>
[Subaddress Box List]	<p>This item is displayed for fax-compatible machines.</p> <p>➔ FAX Operation Guide</p>
[Application Status]	<p>Prints the Application status. You can check the information of the applications installed on this machine.</p>
[Configuration List]	<p>Print the system settings as the list.</p>

Item	Description
[Data Sanitization Report]	Prints the data sanitization report.

Result Report Setting

[System Menu / Counter] key > [Notification/Report] > "Result Report Setting"

[Send Result Report]

Automatically print a report of transmission result when a transmission is complete.

Item	Description
[Email/Folder]	Automatically print a report of transmission result when Email or SMB/FTP transmission is complete. Value: [Off], [On], [Error Only]
[Fax]* ¹	➔ FAX Operation Guide
[Canceled before Sending]* ²	Print a send result report if the job is canceled before being sent. Value: Off, On
[Recipient Format]* ²	Select the Recipient Format for the send result report. Value: [Name or Destination], [Name and Destination]

*1 This item is displayed for fax-compatible machines.

*2 Not displayed if both "Email/Folder" and "Fax" are [Off].

[RX Result]

This item is displayed for fax-compatible machines.

For details, refer to the following:

➔ **FAX Operation Guide**

[Job Finish Notice Setting]

This item is displayed for fax-compatible machines.

For details, refer to the following:

➔ **FAX Operation Guide**

Device Status Notification

[System Menu / Counter] key > [Notification/Report] > "Device Status Notification"

[Low Toner Alert]

➔ [Low Toner Alert \(page 441\)](#)

[Time for Maintenance Alert]

Item	Description
[Notify via Operation Panel]	Set whether or not to display on the operation panel when a periodic maintenance is soon. Value: [Off], [Display Status], [Display Status and Error]
[Notify Externally (for administration use)]	Set the timing at which the administrator will be notified of the period remaining before the upcoming scheduled maintenance when it is soon. This notification is used for Event Reports, Status Monitors, and SNMPTraps (such as Printing Equipment Management Systems). Value: Off, On  NOTE If On is selected, set the timing of notification. The setting range is 5 to 100% (in 1% increments).

Fax Communication Report

[System Menu / Counter] key > [Notification/Report] > "Fax Communication Report"

Configure settings for Outgoing Fax report and Incoming Fax report.

This item is displayed for fax-compatible machines.

For details, refer to the following:

➔ **FAX Operation Guide**

History Settings

[System Menu / Counter] key > [Notification/Report] > "History Settings"

NOTE

For details on the Log History, refer to the following:

→ [History Management \(page 447\)](#)

[Sending Log History]

Item	Description
[Auto Sending]	<p>This function automatically sends the log history to the specified destinations whenever a set number of jobs has been logged. Value: [Off], [On]</p> <hr/> <p> NOTE If [On] is selected, specify the number of job histories. The setting range is 1 to 16.</p>
[Destination]	Set the destination to which log histories are sent. Only E-mail address can be set.
[Subject]	Set the subject automatically entered when sending log histories by E-mail. Value: Up to 256 characters
[SSFC]	Enter the subject of the printed job history with IC card authentication. Value: Up to 256 characters
[Personal Information]	Select whether to include personal information in the job log. Value: [Include], [Exclude]
[Send Log History]	You can also send the log history to the specified destinations manually.

History Management

It is possible to perform Log Management for the following logs on this machine.

Jobs Log

Log subject

- Copy/Fax/Scan/Send/Print job completion
- Checking job status/Changing of jobs/Canceling of jobs

Log information

- Event occurrence date and time
- Event type
- Information on users logged in (or users who attempted to log in)
- Event results (Success/Failure)

 **NOTE**

If the user authentication screen appears, log in with a user who has the privilege to configure this setting. If you do not know your login user name or password, please contact your administrator.

FunctionSettings

Configures settings for copying, sending and Document Box functions.

Function Defaults

[System Menu / Counter] key > [FunctionSettings] > [Function Defaults]

[Common]

[System Menu / Counter] key > [FunctionSettings] > [Function Defaults] > [Common]

[Clear Settings after Job Started]

→ [Clear Settings after Job Started \(page 439\)](#)

[File Name Entry]

Set an automatically entered name (default) for jobs. Additional information such as Date and Time and Job No. can also be set.

Value

File Name: Up to 32 characters can be entered.

Additional information: [None], [Job No.], [Date and Time], [[Job No.] & [Date and Time]], [[Date and Time] & [Job No.]]

[Border Erase Default]

Set the default width to be erased as a border.

Value

Metric

0 to 50 mm (in 1 mm increments)

Inch

0 to 2" (in 0.01" increments)

NOTE

To specify border erase widths around original, set the value in "Border". To specify border erase widths in the middle of original, set the value in "Gutter".

Item	Description
[Border Erase to Back Page]	Select the Border Erase Method for Back Page of a sheet. Value: [Same as Front Page], [Do Not Erase]

[Zoom]

Select the enlarged/reduced default when paper size/sending size changed after the originals set.

Value: [100%], [Auto]

[DP Read Action]

Set the operation when a document is scanned from the document processor.

Value: [Speed Priority], [Quality Priority]

[Detect Multi-fed Originals]

When scanning a document from the document processor, scanning is automatically stopped when multi fed originals is detected.

This function is available only for TASKalfa MA4500ci.

Value	Description
On	In case of detecting that multiple sheets of original are fed at the same time, the message is displayed and stop scanning the original.
Off	It does not detect.

[Detect Folded Corner Originals]

Value	Description
On	When scanning a document from the document processor, scanning is automatically stopped when a document with a folded corner is detected.
Off	It does not detect.

[Quiet Mode]

Value	Description
[Quiet Mode]	Set the quiet mode. Select this mode when the running noise is uncomfortable. Value: Off, On
[Specify Each Job]	You can set the quiet mode for each job, such as copy and send. Here, set whether to allow the setting for each job. Value: [Permit], [Prohibit]

[Copy/Print]

[System Menu / Counter] key > [FunctionSettings] > [Function Defaults] > [Copy/Print]

Item	Description
[Original Size]	Set the default value for the original size. When Standard Size Detection is OFF, the size set in the default original size is displayed as an option. These settings are in [Original/Scan Settings]. Standard Size Detection: On Value: [Auto (Standard Size)], [Auto (Non-standard Size)] Standard Size Detection: Off Value: [Auto (Non-standard Size)], Original Size (default size)
[Original Orientation (Copy)]	Set the original orientation defaults. Value: [Top Edge on Top], [Top Edge on Left], [Auto] ^{*1}
[Color Selection (Copy)]	Set the default copying color mode setting. Value: [Auto Color], [Full Color], [Black & White]
[Color Balance]	Sets the default color balance value. Value: Cyan (-5 to 5), Magenta (-5 to 5), Yellow (-5 to 5), Black (-5 to 5)
[Original Image (Copy)]	Set the default original document type for copying. Value: [Text+Photo], [Photo], [Text], [Graphic/Map], [Printer Output]
[Background Density Adj. (Copy)]	Set the default Background Density (Copy). Value: [Off], [Auto], [Manual (Darker 5)]
[Continuous Scan (Copy)]	Select the default Continuous Scan (Copy) setting. Value: Off, On
[Prevent Bleed-through (Copy)]	Set the default value for preventing bleed-through (Copy). Value: Off, On
[Skip Blank Page (Copy)]	Set the default Skip Blank Page status. Value: Off, On
[EcoPrint]	Select the EcoPrint default. Value: Off, On
[Border Erase (Copy)]	Set the defaults for Border Erase (Copy). Value [Standard], [Border Erase Sheet], [Border Erase Book], [Individual Border Erase]
[Collate]	Set the defaults for Collate. Value Off, On
[JPEG/TIFF Print]	Select the image size (resolution) when printing JPEG or TIFF file. Value: [Fit to Paper Size], [Image Resolution], [Fit to Print Resolution]
[XPS Fit to Page]	Set the default value for the XPS fit to page function. Value: Off, On

Item	Description
[Reserve Next Priority]	Specify whether the default screen appears when a subsequent copy job is reserved while printing is in progress. To have the default screen appear, select On. Value: Off, On
[Auto % Priority]	When a paper source of different size from the original is selected, select whether automatic zoom (reduce/zoom) is performed. Value: Off, On
[ID Card Copy]	Select the ID Card Copy default. [Card Position on Platen] No card position specified or set it to top left. Value: [Free], [Upper Left] [Finishing Layout] Sets the copy position on the paper to center or top right. Value: [Align Center], [Align Upper Right]

*1 This function can only be used when the optional OCR Scan Activation Kit is installed.

➔ [Scan Extension Kit\(A\) AC <Scan function expansion kit \(Activate\)> \(page 745\)](#)

[Send/Store]

[System Menu / Counter] key > [FunctionSettings] > [Function Defaults] > [Send/Store]

Setting	Description
[Original Size]	Set the default value for the original size. When Standard Size Detection is OFF, the size set in the default original size is displayed as an option. These settings are in [Original/Scan Settings]. Detection of standard size: On Value: [Auto (Standard Size)], [Auto (Non-standard Size)] Standard Size Detection: Off Value: [Auto (Non-standard Size)], Original Size (default size)
[Original Orientation (Send/Store)]	Set the original orientation defaults. Value: [Top Edge on Top], [Top Edge on Left], [Auto]* ¹
[Color Selection (Send/Store)]	Select the default color mode for scanning documents. Value: [Auto Color (Color/Gray)], [Auto Color (Color/B & W)], [Full Color], [Grayscale], [Black & White]
[Scan Resolution]	Select the default scanning resolution for scanning documents. Value: [600 x 600 dpi], [400 x 400 dpi Ultrafine], [300 x 300 dpi], [200 x 400 dpi Superfine], [200 x 200 dpi Fine], [200 x 100 dpi Normal]
[Fax TX Resolution]	This item is displayed for fax-compatible machines. ➔ FAX Operation Guide
[Org. Image (Send/Store)]	Set the default original document type for sending/storing. Value: [Text+Photo], [Photo], [Text], [Text (Fine Line)], [Text (for OCR)]
[Clarify Text (Noise Removal) Settings]	When scanning and sending a document in black and white, it eliminates background noise and improves the legibility of characters. Value: Off, On
[Background Density Adj. (Send/Store)]	Set the default Background Density (Send/Store). Value: [Off], [Auto], [Manual (Darker 5)]
[Continuous Scan (Send/Store)]	Select the default Continuous Scan (Send/Store) setting. Value: Off, On
[Continuous Scan (Fax)]	This item is displayed for fax-compatible machines. ➔ FAX Operation Guide
[Prevent Bleed-through (Send/Store)]	Set the default Prevent Bleed (Send/Store). Value: Off, On
[Border Erase/Full Scan (Send/Store)]	Set the defaults for Border Erase/Full Scan (Send/Store). Value: [Standard], [Full Scan], [Border Erase Sheet], [Border Erase Book], [Individual Border Erase]
[Border Erase/Full Scan (Fax)]	This item is displayed for fax-compatible machines. ➔ FAX Operation Guide

Setting	Description
[Skip Blank Page (Send/Store)]	Set the default Skip Blank Page status. Value: Off, On
[File Format]	Set the default type of the files. Value: [PDF], [TIFF], [JPEG], [XPS], [OpenXPS], [High Comp. PDF], [Word], [Excel], [PowerPoint]
[Image Quality (File Format)]	Select the default PDF/TIFF/JPEG/XPS/OpenXPS/Word/Excel/PowerPoint file quality. Value: [1] Low Quality (High Comp.) to[5] High Quality (Low Comp.)
[High Comp. PDF Image]	Select the default quality setting for high compressed PDF files. Value: [Compression Ratio Priority], [Standard], [Quality Priority]
[Color TIFF Compression]	Select the compression method for sending the color documents in the TIFF format. Value: [TIFF V6], [TTN2]
[PDF/A]	Select the default PDF/A setting. Value: [Off], [PDF/A-1a], [PDF/A-1b], [PDF/A-2a], [PDF/A-2b], [PDF/A-2u]  NOTE If [On] is selected in "Digital Signature", [PDF/A-1a] and [PDF/A-1b] cannot be selected. ➔ Digital Signature to File (page 456)
[OCR Text Recognition Action] ^{*1}	Configure settings for OCR Text Recognition Action. Value: [Speed Priority], [Quality Priority]
[OCR Text Recognition] ^{*1}	Set the default OCR Text Recognition. Value: Off, On
[Primary OCR Language] ^{*1}	Set the default language of the text to be extracted. Select the language to extract from the options displayed on the touch panel.
[OCR Output Format] ^{*1}	Set the default OCR output format. Value: [Text + Graphics], [Text + Graphics with Scanned Image], [Scanned Image with Searchable Text]
[File Separation]	Select the default file separation setting. Value: [Off], [Each Page]
[Email Subject/Body]	Set the subject and body automatically entered (default subject and body) when sending the scanned originals by E-mail. Value Subject: Up to 256 characters can be entered. Body 1 to 3: Up to 500 characters can be entered.

*1 This function can only be used when the optional OCR Scan Activation Kit is installed.

➔ [Scan Extension Kit\(A\) AC <Scan function expansion kit \(Activate\)> \(page 745\)](#)

Copy/Print

[System Menu / Counter] key > [FunctionSettings] > [Copy/Print]

Item	Description
[Quick Setup Registration (Copy)]	➔ Quick Setup Registration (Copy) (page 425)

Send/Store

[System Menu / Counter] key > [FunctionSettings] > [Send/Store]

[Default Screen]

Set the default screen displayed when you select the [Send] key.

Value: [Destination], [Address Book], [One Touch Key]





[Prevent Mis-sending Settings]

Item	Description
[Destination Check before Send]	Select whether to display the confirmation screen of destinations after pressing the [Start] key when performing sending jobs. Value: Off, On
[Entry Check for New Dest.]	When adding new destination, select whether to display the entry check screen to check the entered destination. Value: Off, On
[New Destination Entry]	Select whether to permit direct entry of destination. Value: [Prohibit], [Permit]
[Recall Destination]	Select whether to permit usage of [Recall] on the Send screen. Value: [Prohibit], [Permit]
[Broadcast]	Set whether to enable broadcast. Value: [Prohibit], [Permit]
[Destination History Usage]	Allow to use the destination history. Value: [Prohibit], [Permit]
[Delete Destination History]	Delete the destination history.

[Quick Setup Registration (Send)]

➔ [Quick Setup Registration \(Send\) \(page 425\)](#)



[Digital Signature to File]

Item	Description
[Digital Signature]	<p>Select whether to add a digital signature. Value</p> <p>[Off] Does not add a digital signature.</p> <p>[Specify Each Job] Whether to add a digital signature is selected each time of sending.</p> <p>[On] Always adds a digital signature when sending.</p> <hr/> <p> NOTE When [On] is selected, [PDF/A-1a] and [PDF/A-1b] cannot be selected in "PDF/A". → PDF/A (page 454)</p>
[Digital Signature Format]	<p>Select an algorithm used for encryption of digital signature. Value: [SHA-1], [SHA-256], [SHA-384], [SHA-512]</p> <hr/> <p> NOTE This function is displayed when Digital Signature is set to [Specify Each Job] or [On].</p>
[Password Confirmation on Signature Permission]	<p>Select whether to confirm password when setting digital signature. Value: [Off], [On]</p> <hr/> <p> NOTE This function is displayed when Digital Signature is set to [Specify Each Job].</p>
[Password]	<p>Set a password required for setting digital signature. Enter a new security password 6 to 16 alphanumeric characters and symbols.</p> <hr/> <p> NOTE This function is displayed when "Password Confirmation on Signature Permission" is set to [On].</p>

Email

[System Menu / Counter] key > [FunctionSettings] > [Email]

[Email Settings]

Item	Description
[SMTP (Email TX)]	Select whether to send E-mail using SMTP. Value: Off, On
[SMTP Server Name]	Enter the host name or IP address of the SMTP server. <hr/>  NOTE Up to 256 characters can be entered. <hr/>
[SMTP Port Number]	Specify the port number to be used for SMTP. The default port number is 25. Value: 1 to 65535 (Port Number)
[Sender Address]	Specify the sender address for when the machine sends E-mails. Non-delivery report may be sent back to the sender address specified here. It is recommended that you specify an e-mail address that can be received by the device administrator. The sender address must be entered correctly for SMTP authentication. The maximum length of the sender address is 256 characters.
[SMTP Auth and Sender Address]	When the user login is set to ON, login user name, password and E-mail address of login user are used for SMTP authentication and e-mail sender address. Value [Use System Settings] Information set with [Sender Address] is used for SMTP authentication and E-mail sender address information. [Use Login User Information] Login User information is used for SMTP authentication and E-mail sender address information. <hr/>  NOTE If there is no e-mail address set for the user who logged in, the Sender Address set with [Sender Address] is used for E-mail sender address information. <hr/>

[POP3]

Item	Description
[POP3]	Select whether to receive E-mail using POP3. Value: Off, On
[Remote Printing]	➔ Remote Printing (page 469)

Sending Job - Folder

[System Menu / Counter] key > [FunctionSettings] > [Sending Job - Folder]

Item	Description
[FTP Settings]	Select whether to send documents using FTP. To use this function, set it to On in "Protocol Settings". The default port number is 21. Value: Off, On, 1 to 65535 (Port Number)
[SMB Settings]	Select whether to send documents using SMB. To use this function, set it to [On] in "Protocol Settings". The default port number is 445. Value: Off, On, 1 to 65535 (Port Number)

Fax

[System Menu / Counter] key > [FunctionSettings] > [Fax]

Configures settings for fax functions.

This item is displayed for fax-compatible machines.

For details, refer to the following:

➔ **FAX Operation Guide**

WSD

[System Menu / Counter] key > [FunctionSettings] > [WSD]

[WSD Scan]

Item	Description
[Protocol Settings]	Select whether to use WSD Scan. The setting will be changed after restarting the device or network. Value: Off, On
[Available Network]	Set whether to enable this function for each network of Wi-Fi Direct, Wi-Fi and wired. Value: [Disable], [Enable]

[WSD Print]

Item	Description
[Protocol Settings]	Set whether to use our proprietary web services. WIA driver, TWAIN driver and Network FAX driver use this Enhanced WSD web service. The setting will be changed after restarting the device or network. Value: Off, On
[Available Network]	Set whether to enable this function for each network of Wi-Fi Direct, Wi-Fi and wired. Value: [Disable], [Enable]

Address Book

[System Menu / Counter] key > [FunctionSettings] > [Address Book]

[Add/Edit Machine Address Book]

Configure settings for address book.

➔ [Adding a Destination \(Address Book\) \(page 173\)](#)

[Machine Address Book]

Item	Description
[Sort]	Select the default sort setting of the address for the address book. Value: [No.], [Name (Kana)]
[Narrow Down]	This procedure can be used to filter (narrow down) the types of destination listed when the address book is displayed. Value: [Off], [Email], [Folder], [Fax] ^{*1} , [Group]
[Edit Restriction]	Restrict editing of the address book. If you select [Administrator Only], you can only edit the Address Book by logging in as administrator. Value: [Off], [Administrator Only]

*1 This item is displayed for fax-compatible machines.

[External Address Book]

➔ [Command Center RX User Guide](#)

[Address Book Type]

Select whether the machine's address book or the External Address Book appears when the address book is displayed.

This is displayed only if the external address book is available.

Value: [Machine Address Book], [External Address Book]

One-Touch Key

[System Menu / Counter] key > [FunctionSettings] > [One-Touch Key]

Item	Description
[Add/Edit One-Touch Key]	Configure settings for One Touch Key. ➔ Adding a Destination on One Touch Key (page 185)
[Edit Restriction]	Restrict editing of the One Touch Key. If you selected [Administrator Only], you can only edit the One Touch Key by logging in with administrator privileges. Value: [Off], [Administrator Only]

Send and Forward

[System Menu / Counter] key > [FunctionSettings] > [Send and Forward]

[Forward Settings]

Select whether to forward the original.

Value: Off, On

NOTE

If you select On, select the forwarding conditions from the following:

- [Email]
- [Folder (SMB)]
- [Folder (FTP)]
- [Fax]

This item is displayed for fax-compatible machines.

[Destination]

Item	Description
[Add]	<p>Set the destination to forward the original. Only one destination can be set. The registration method of the destination is the following.</p> <ul style="list-style-type: none">• Addr. Book• Email• SMB• FTP <p>➔ Specifying Destination (page 269)</p>

Forward setting

[System Menu / Counter] key > [FunctionSettings] > [Forward setting]

Configure the transfer settings.



This item is displayed for fax-compatible machines.

For details, refer to the following:



➔ **FAX Operation Guide**

Printer

[System Menu / Counter] key > [FunctionSettings] > [Printer]

Item	Description
[Emulation]	<p>Select the emulation for operating this machine by commands oriented to other types of printers. Value: [PCL6], [KPD L], [KPD L (Auto)]</p> <hr/> <p> NOTE</p> <ul style="list-style-type: none"> • When you have selected [KPD L (Auto)], set "Alt Emulation", too. • When you have selected [KPD L] or [KPD L (Auto)], set "KPD L Error Report", too. <hr/> <p>KPD L Error Report</p> <p>When an error has occurred during printing in KPD L emulation mode, set whether or not the error report is output. Value: Off, On</p>
[Color Setting]	<p>You can choose whether reports are printed in color or black and white. Value: [Color], [Black & White]</p>
[Gloss Mode]	<p>Gloss Mode increases the effect of glossiness in printing. However, printing takes longer time. Value: Off, On</p> <hr/> <p> IMPORTANT</p> <p>This function is not available when [Labels] or [Transparency] is selected as the paper type setting.</p> <p>➔ Paper Feeding (page 430)</p> <p>Depending on the paper used, printing in gloss mode may cause curl in paper. To reduce curl, try using thicker paper.</p>
[EcoPrint]	<p>EcoPrint conserves toner when printing. This is recommended for test copies where faded printing is not a problem. Value: Off, On</p>
[Override A4/Letter]	<p>Select whether to treat A4 size and Letter, which are similar in size, as the same size when printing. Value</p> <p>Off</p> <p>A4 and Letter are not regarded as the same in size.</p> <p>On</p> <p>A4 and Letter are regarded as the same in size. The machine will use whichever size is in the paper source.</p>
[Duplex]	<p>Select binding orientation for duplex mode. Value: [1-sided], [2-sided (Bind Long Edge)], [2-sided (Bind Short Edge)]</p>

Item	Description
[Copies]	Set the default number of copies, from 1 to 9999. Value: 1 to 9999 copies
[Orientation]	Set the default orientation, [Portrait] or [Landscape]. Value: [Portrait], [Landscape]
[Form Feed Timeout]	Receiving print data from the computer, the machine may sometimes wait if there is no information signaling that the last page does not have any more data to be printed. When the preset timeout passes, the machine automatically prints paper. The options are between 5 and 495 seconds. Value: 5 to 495 seconds (in 5 second increments)
[LF Action]	Set the line feed action when the machine receives the line feed code (character code 0AH). Value: [LF Only], [LF and CR], [Ignore LF]
[CR Action]	Set the character return action when the machine receives the character return code (character code 0DH). Value: [CR Only], [LF and CR], [Ignore CR]
[Job Name]	Set whether the job name set in the printer driver is displayed. Value: Off, On <hr/>  NOTE If you select On, select from [Job Name], [Job No. & Job Name] or [Job Name & Job No.] to use as the job name. <hr/>
[User Name]	Set whether the user name set in the printer driver is displayed. Value: Off, On
[Paper Feed Mode]	While printing from the computer, select how to feed paper when the paper source and type are specified. Value [Auto] Search the paper source that matches the selected paper size and type. [Fixed] Print on paper loaded in the specified paper source.

Item	Description
[MP Tray Priority]	<p>If paper is set in the MP Tray then it is possible for priority to be given to that MP tray in the paper feed.</p> <p>Value</p> <p>[Off]</p> <p>The printer driver settings are followed.</p> <p>[Auto Feed]</p> <p>If Auto is selected in the printer driver and there is paper in the MP tray then the paper feed will be from the MP tray.</p> <p>[Always]</p> <p>If there is paper in the MP tray then the paper feed will be from the MP tray regardless of what is set in the printer driver.</p>
[Auto Cassette Change]	<p>Select the following actions when the paper runs out in the paper source while printing.</p> <p>Value: Off, On</p> <hr/> <p> NOTE</p> <ul style="list-style-type: none"> • When selecting Off, the machine displays "Add the following paper in cassette #." (# is a cassette number) or "Add paper in Multipurpose Tray.", and stops printing. • When you load the paper in the cassette displayed in the message, printing resumes. • If you wish to print from another cassette, select the desired paper source with [Paper Selection]. • When selecting On, the machine continues printing automatically when the other cassette contains the same paper as the currently-used cassette. <hr/>
[Message Banner Print]	<p>Set whether the confirmation screen appears before each sheet is printed when printing banner sheet.</p> <p>Value: Off, On</p>
[Wide A4]	<p>Turn this to On to increase the maximum number of characters that can be printed in a line for an A4 page (78 characters at 10 pitch) and Letter size page (80 characters at 10 pitch). This setting is only effective in PCL6 emulation.</p> <p>Value: Off, On</p>
[Resolution]	<p>Set the resolution used for printing.</p> <p>Value: [600 dpi], [1200 dpi]</p> <hr/> <p> NOTE</p> <p>Settings that are received from the printer driver have priority over the operation panel settings.</p> <hr/>
[KIR]	<p>Select the default KIR (smoothing) setting.</p> <p>Value: Off, On</p>

Item	Description
[Printing Job Terminator]	<p>You can select the condition which is regarded as a job termination if the print job could not be processed until the end due to your environment and the other reason.</p> <p>Value</p> <p>[EOJ (End of Job)] The command recognized as a termination of the job data is regarded as one job until it is detected.</p> <p>[End of Network Session] The data included in a network session at network connection is regarded as one job.</p> <p>[UEL (Universal Exit Language)] The UEL included in the termination of the job data is regarded as one job until it is detected.</p>
[Remote Printing]	<p>Select whether to prohibit printing that is performed without operating the machine. When [Prohibit] is selected, a document that has been stored in the document box from the printer driver can be printed from the machine. This prevents another person from seeing that document.</p> <p>Value: [Prohibit], [Permit]</p> <hr/> <p> NOTE</p> <p>If [Prohibit] is selected, printing and storing using Quick Copy and Proof and Hold functions are disabled. Printing a received FAX (optional) is not prohibited.</p> <hr/>
[Direct Printing from Web]	<p>Set whether to allow Direct Printing from Command Center RX.</p> <p>Value: [Not Allowed], [Allowed]</p> <p>➔ Command Center RX User Guide</p>



Document Box

[System Menu / Counter] key > [FunctionSettings] > [Document Box]

Item	Description
[Custom Box - Add/Edit]	➔ Creating a New Custom Box (page 283)
[Auto File Deletion Time]	Set the time to automatically delete stored documents.
[Quick Setup Registration (Storing in Box)]	➔ Quick Setup Registration (Storing in Box) (page 425)
[Quick Setup Registration (Box Print)]	➔ Quick Setup Registration (Box Print) (page 425)
[Quick Setup Registration (Sending from Box)]	➔ Quick Setup Registration (Sending from Box) (page 426)

Job Box

[System Menu / Counter] key > [FunctionSettings] > [Job Box]

Item	Description
[Quick Copy Job Retention]	<p>To maintain free space in the box, you can set the maximum number of stored jobs. Value: number between 0 and 300</p> <hr/> <p> NOTE When 0 is set, Quick Copy cannot be used.</p> <hr/>
[Deletion of Job Retention]	<p>This setting specifies that documents, such as Private Printing, Quick Copying, or Proof and Hold Printing, saved temporarily in the job box are automatically deleted after they have been saved for a set time. Value: [Off], [1 hour], [4 hours], [1 day], [1 week]</p> <hr/> <p> NOTE This function is valid for documents saved after the function is set. Regardless of this function setting, temporary documents are deleted when the power switch is turned off.</p> <hr/>
[Deletion of PIN Print at Power Off]	<p>Set whether or not the jobs stored in the PIN Print Box is deleted when the power is turned off. Value: [Off], [On]</p>
[Storage Media]	<p>Set the save destination of the Job Box. Displayed when the optional SSD and an SD card are installed. Value: [SSD], [SD Card]</p>

Subaddress Box

[System Menu / Counter] key > [FunctionSettings] > [Subaddress Box]

Registers a subaddress box that uses subaddress based communication.

This item is displayed for fax-compatible machines.

For details, refer to the following:

➔ **FAX Operation Guide**

Fax Memory RX Box

[System Menu / Counter] key > [FunctionSettings] > [Fax Memory RX Box]

Set whether to perform print immediately for the FAX documents received or to save them in the Fax Memory RX Box.

This item is displayed for fax-compatible machines.

For details, refer to the following:

➔ **FAX Operation Guide**

Home

[System Menu / Counter] key > [FunctionSettings] > [Home]

Configure settings for Home screen.

➔ [Editing the Home Screen \(page 61\)](#)

Status

[System Menu / Counter] key > [FunctionSettings] > [Status]

[Job Status/Job Logs Settings]

Set the display of Job Status/Jobs History.

Item	Description
[Display Jobs Detail Status]	Value: [Show All], [My Jobs Only], [Hide All]
[Display Jobs Log]	Value: [Show All], [My Jobs Only], [Hide All]
[Display Fax Log]	Value: [Show All], [Hide All] This item is displayed for fax-compatible machines.
[Pause/Resume of All Print Jobs]	Value: [Prohibit], [Permit]

Remote Services

[System Menu / Counter] key > [FunctionSettings] > [Remote Services]

When the trouble occurs on this product, it is possible to explain the operational procedure and the troubleshooting method through the internet from our sales office by accessing the operation panel screen of this product while operating the screen.

 **NOTE**

When using the remote service settings, it is necessary to make a contract with our company. Please contact our sales office or our authorized dealer (purchase source) for the details.

TWAIN/WIA

[System Menu / Counter] key > [FunctionSettings] > [TWAIN/WIA]

Item	Value
[Enhanced WSD]	Set whether to use our proprietary web services. Value: Protocol Settings: On, Off
[Enhanced WSD over TLS]	Set whether to use our proprietary web services. Value: Protocol Settings: On, Off

 **NOTE**

The setting will be changed after restarting the device or network.

If you select [Off], the WIA driver, TWAIN driver, and Network FAX driver are not available.

NetworkSettings

Configures network settings.

Host Name

[System Menu / Counter] key > [NetworkSettings] > "Network Settings" [Host Name]

Item	Description
[Host Name]	Check the host name of the machine. Host name can be changed from Command Center RX. ➔ Changing Device Information (page 124)

Proxy

[System Menu / Counter] key > [NetworkSettings] > "Network Settings" [Proxy]

Item	Description
[Proxy]	Set the proxy for connection to the Internet from an application. Value: [Off], [Use Different Proxy Server], [Use the Same Proxy Server for All Protocols]
[Proxy Server (HTTP)]	Set a proxy server (HTTP). Value: (Enter the proxy address and port number.)
[Proxy Server (HTTPS)]	Set a proxy server (HTTPS). This setup is available when "Proxy" is set to [Use Different Proxy Server]. Value: (Enter the proxy address and port number.)
[Do Not Use Proxy for Following Domains]	Set domains for which no proxy is used. Value: (Enter the domain name.)

Wi-Fi Direct Settings





[System Menu / Counter] key > [NetworkSettings] > "Network Settings" [Wi-Fi Direct Settings]

Set Wi-Fi Direct.

NOTE

This function is displayed when the Wireless Network Interface Kit (IB-37 or IB-38) is installed.

The Wireless Network Interface Kit is an option for some models. Contact your dealer or our sales or service representatives for detail.

Item	Description
[Wi-Fi Direct]	Select whether to use Wi-Fi Direct. Value: Off, On
[Device Name]	Specify the device name.  NOTE <ul style="list-style-type: none"> Up to 32 characters can be entered. This function is displayed when [Wi-Fi Direct] is set to On.
[IP Address]	Check the IP address of the machine. TCP/IP Settings  NOTE This function is displayed when [Wi-Fi Direct] is set to On.
[Auto Disconnect]	Automatically disconnect devices connected through Wi-Fi Direct. Value: Off, On  NOTE <ul style="list-style-type: none"> If you select On, set the waiting time for automatic disconnection. This function is displayed when [Wi-Fi Direct] is set to On.
[Persistent Group]	Set whether Wi-Fi Direct connection as Persistent Group (information for the connection is kept even if the power is turned off). Value: Off, On  NOTE This function is displayed when [Wi-Fi Direct] is set to On.
[Frequency Band]	Set the frequency band to be used. Specify when using IB-37/IB-38. Value: [2.4 GHz], [5 GHz]

Item	Description
[Password]	<p>Select whether the Wi-Fi Direct password is automatically generated or created manually.</p> <p>When "Manual Creation" is set to ON, the "Persistent Group" setting changes to ON.</p> <p>Value: Off, On</p> <hr/> <p> NOTE</p> <p>If "Manual Creation" is set to ON, set a password (8 or more characters).</p>

Wi-Fi Settings

[System Menu / Counter] key > [NetworkSettings] > "Network Settings" [Wi-Fi Settings]

Set Wi-Fi Direct.

NOTE

This function is displayed when the Wireless Network Interface Kit (IB-37 or IB-38) is installed.

The Wireless Network Interface Kit is an option for some models. Contact your dealer or our sales or service representatives for detail.

Wi-Fi

Item	Description
[Wi-Fi]	<p>Select whether to use Wi-Fi.</p> <p>Value: Off, On</p>

Setup

[Available Network]

Displays access points to which the machine can connect.

Item	Description
[Index]	<p>Select the key index of the access point.</p> <p>Value: 0 to 3</p>

[Push Button Method]

If the access point supports the push button method, wireless settings can be configured using the push button. This setting executes push button, and the connection is started by pressing the push button on the access point.

 **NOTE**

The push button method supports only the WPS.

[PIN Code Method (Device)]

Starts connection using the machine's PIN code. Enter the PIN code into the access point. The PIN code of the machine is automatically generated.

[Custom Setup]

The detailed settings for wireless LAN can be changed.

Item	Description
[Network Name (SSID)]	Set the SSID (Service Set Identifier) of the wireless LAN to which the machine connects. <hr/>  NOTE Up to 32 characters can be entered. <hr/>
[Network Authentication]	Select network authentication type. Value: [Open], [WPA2/WPA-PSK], [WPA2-PSK], [WPA2/WPA-EAP], [WPA2-EAP], [WPA3-SAE/WPA2-PSK], [WPA3-SAE], [WPA3/WPA2-EAP], [WPA3-EAP]

Item	Description
[Encryption]	<p>Select encryption method. The setting values vary depending on the Network Authentication setting.</p> <p>Open Value: [Disable], [WEP]</p> <hr/> <p> NOTE If you selected [WEP], set the WEP key (up to 26 characters) and WEP Key Index (0 to 3).</p> <hr/> <p>WPA2/WPA-PSK Value: [AES], [Auto], [Preshared Key] (up to 64 characters)</p> <p>WPA2-PSK Value: [Preshared Key] (up to 64 characters)</p> <p>WPA2/WPA-EAP Value: [AES], [Auto]</p> <p>WPA2-EAP Value: —</p> <p>WPA3-SAE/WPA2-PSK Value: [Preshared Key] (up to 64 characters)</p> <p>WPA3-SAE Value: [Preshared Key] (up to 64 characters)</p> <p>WPA3/WPA2-EAP Value: —</p> <p>WPA3-EAP Value: —</p>

TCP/IP Settings**TCP/IP**





Select whether to use TCP/IP Protocol.

Value: Off, On

[IPv4 Settings]

Set up TCP/IP (IPv4) to connect to the network.

This setting is available when TCP/IP is On.



Item	Description
DHCP	Select whether to use the DHCP (IPv4) server. Value: Off, On
Auto-IP	Select whether to use Auto-IP. Value: Off, On
IP Address	Set the IP address. Value: ###.###.###.###  NOTE When DHCP is set to On, the value cannot be entered.
Subnet Mask	Set the IP subnet mask. Value: ###.###.###.###  NOTE When DHCP is set to On, the value cannot be entered.
Default Gateway	Set the IP gateway address. Value: ###.###.###.###  NOTE When DHCP is set to On, the value cannot be entered.
DNS Server Address	Set the IP address of DNS (Domain Name System) server. Value: [Use DNS Server from DHCP], [Use the following DNS Server]  NOTE When [Use the following DNS Server] is selected, enter the DNS server IP address into "DNS Server (Primary)" and "DNS Server (Secondary)".
DNS over TLS	Set whether to connect to a DNS server during communication protected by TLS. Value: [Off], [On], [Auto]



✔ IMPORTANT

- When setting the Auto-IP, enter "0.0.0.0" in IP Address.
- After changing the setting, restart the network or turn the machine OFF and then ON.

[IPv6 Settings]

Set up TCP/IP (IPv6) to connect to the network. This setting is available when TCP/IP is On.

Item	Description
IPv6	<p>Select whether to use IPv6. Value: Off, On</p> <hr/> <p> NOTE</p> <p>Selecting ON displays IP address in "IPAddr.(LinkLocal)" after restarting the network.</p>
Manual Setting	<p>Manually specify the IP address, prefix length, and gateway address of TCP/IP (IPv6). Value</p> <p>IP Address (Manual) 128-bits address is expressed in eight groups consisting of four-digit hexadecimal digits. The groups are separated by colon (:).</p> <p>Prefix Length 0 to 128</p> <p>Default Gateway 128-bits address is expressed in eight groups consisting of four-digit hexadecimal digits. The groups are separated by colon (:).</p> <hr/> <p> NOTE</p> <ul style="list-style-type: none"> • This function is displayed when "IPv6" is set to On. • To enter "Default Gateway", set "RA (Stateless)" to Off.
RA (Stateless)	<p>Select whether to use RA (Stateless). Value: Off, On</p> <hr/> <p> NOTE</p> <ul style="list-style-type: none"> • This function is displayed when "IPv6" is set to On. • Selecting On displays IP address in [IP Address (Stateless)] after restarting the network.

Item	Description
DHCP	<p>Select whether to use the DHCP (IPv6) server. Value: Off, On</p> <hr/> <p> NOTE</p> <ul style="list-style-type: none"> • This function is displayed when "IPv6" is set to On. • Selecting ON displays IP address in IP Address (Stateful) after restarting the network.
DNS Server Address	<p>Set the IP address of DNS (Domain Name System) server. Value: [Use DNS Server from DHCP], [Use the following DNS Server]</p> <hr/> <p> NOTE</p> <p>When [Use the following DNS Server] is selected, enter the DNS server IP address into "DNS Server (Primary)" and "DNS Server (Secondary)".</p>
DNS over TLS	<p>Set whether to connect to a DNS server during communication protected by TLS. Value: [Off], [On], [Auto]</p>

 **IMPORTANT**

After changing the setting, restart the network or turn the machine OFF and then ON.

Wired Network Settings

[System Menu / Counter] key > [NetworkSettings] > "Network Settings" [Wired Network Settings]

Configure wired network settings.

TCP/IP Settings

TCP/IP



Select whether to use TCP/IP Protocol.

Value: Off, On

[IPv4 Settings]

Set up TCP/IP (IPv4) to connect to the network.

This setting is available when TCP/IP is On.

Item	Description
DHCP	Select whether to use the DHCP (IPv4) server. Value: Off, On
Auto-IP	Select whether to use Auto-IP. Value: Off, On
IP Address	Set the IP address. Value: ###.###.###.###  NOTE When DHCP is set to On, the value cannot be entered.
Subnet Mask	Set the IP subnet mask. Value: ###.###.###.###  NOTE When DHCP is set to On, the value cannot be entered.
Default Gateway	Set the IP gateway address. Value: ###.###.###.###  NOTE When DHCP is set to On, the value cannot be entered.

Item	Description
DNS Server Address	<p>Set the IP address of DNS (Domain Name System) server. Value: [Use DNS Server from DHCP], [Use the following DNS Server]</p> <hr/> <p> NOTE</p> <p>When [Use the following DNS Server] is selected, enter the DNS server IP address into "DNS Server (Primary)" and "DNS Server (Secondary)".</p> <hr/>
DNS over TLS	<p>Set whether to connect to a DNS server during communication protected by TLS. Value: [Off], [On], [Auto]</p>





 **IMPORTANT**

- When setting the Auto-IP, enter "0.0.0.0" in IP Address.
- After changing the setting, restart the network or turn the machine OFF and then ON.

[IPv6 Settings]

Set up TCP/IP (IPv6) to connect to the network. This setting is available when TCP/IP is On.

Item	Description
IPv6	<p>Select whether to use IPv6. Value: Off, On</p> <hr/> <p> NOTE</p> <p>Selecting ON displays IP address in "IPAddr.(LinkLocal)" after restarting the network.</p> <hr/>

Item	Description
Manual Setting	<p>Manually specify the IP address, prefix length, and gateway address of TCP/IP (IPv6). Value</p> <p>IP Address (Manual) 128-bits address is expressed in eight groups consisting of four-digit hexadecimal digits. The groups are separated by colon (:).</p> <p>Prefix Length 0 to 128</p> <p>Default Gateway 128-bits address is expressed in eight groups consisting of four-digit hexadecimal digits. The groups are separated by colon (:).</p> <hr/> <p> NOTE</p> <ul style="list-style-type: none"> • This function is displayed when "IPv6" is set to On. • To enter "Default Gateway", set "RA (Stateless)" to Off.
RA (Stateless)	<p>Select whether to use RA (Stateless). Value: Off, On</p> <hr/> <p> NOTE</p> <ul style="list-style-type: none"> • This function is displayed when "IPv6" is set to On. • Selecting On displays IP address in [IP Address (Stateless)] after restarting the network.
DHCP	<p>Select whether to use the DHCP (IPv6) server. Value: Off, On</p> <hr/> <p> NOTE</p> <ul style="list-style-type: none"> • This function is displayed when "IPv6" is set to On. • Selecting ON displays IP address in IP Address (Stateful) after restarting the network.
DNS Server Address	<p>Set the IP address of DNS (Domain Name System) server. Value: [Use DNS Server from DHCP], [Use the following DNS Server]</p> <hr/> <p> NOTE</p> <p>When [Use the following DNS Server] is selected, enter the DNS server IP address into "DNS Server (Primary)" and "DNS Server (Secondary)".</p>

Item	Description
DNS over TLS	Set whether to connect to a DNS server during communication protected by TLS. Value: [Off], [On], [Auto]

 **IMPORTANT**

After changing the setting, restart the network or turn the machine OFF and then ON.

Others

Item	Description
[LAN Interface]	Specify the settings for the LAN interface to be used. Value: [Auto], [10BASE-T Half], [10BASE-T Full], [100BASE-TX Half], [100BASE-TX Full], [1000BASE-T]

 **IMPORTANT**

After changing the setting, restart the network or turn the machine OFF and then ON.

Protocol Settings

[System Menu / Counter] key > [NetworkSettings] > "Network Settings" [Protocol Settings]

Configures protocol settings.

[SMTP (Email TX)]

→ [Email Settings \(page 457\)](#)

[POP3 (Email RX)]

→ [POP3 \(page 458\)](#)

[FTP Client (Transmission)]

→ [FTP Settings \(page 459\)](#)

[FTP Server (Reception)]

Item	Description
[Protocol Settings]	Set whether to send documents using FTP.* ¹ Value: Off, On
[Available Network]	Set whether to enable this function for each network of Wi-Fi Direct, Wi-Fi and wired. Value: [Disable], [Enable]

[SMB Client (Transmission)]

→ [SMB Settings \(page 459\)](#)

[NetBEUI]

Item	Description
[Protocol Settings]	Set whether to send documents using NetBEUI.* ¹ Value: Off, On
[Available Network]	Set whether to enable this function for each network of Wi-Fi Direct, Wi-Fi and wired. Value: [Disable], [Enable]



[WSD Scan]

→ [WSD Scan \(page 461\)](#)

[WSD Print]

→ [WSD Print \(page 461\)](#)

[ThinPrint]

Item	Settings
[Protocol Settings]	<p>Set whether to use ThinPrint. To use it, select On in these settings. The factory default port number is 4000.*¹*²</p> <p>Value: Off, On</p> <hr/> <p> NOTE</p> <p>This feature does not appear if the optional ThinPrint Option is not running.</p> <hr/>
[ThinPrintoverTLS]	<p>To use ThinPrint over TLS, select [On] for this setting, and for [TLS] in the "SecuritySettings", select [On].</p> <p>Value: Off, On</p> <hr/> <p> NOTE</p> <p>When the setting is On, TLS certificate is required. The factory certificate is the certificate owned by the machine.</p> <hr/>
[Available Network]	<p>Set whether to enable this function for each network of Wi-Fi Direct, Wi-Fi and wired.</p> <p>Value: [Disable], [Enable]</p>

[LPD]

Item	Description
[Protocol Settings]	<p>Set whether to send documents using LPD.*¹</p> <p>Value: Off, On</p>
[Available Network]	<p>Set whether to enable this function for each network of Wi-Fi Direct, Wi-Fi and wired.</p> <p>Value: [Disable], [Enable]</p>

[Raw]

Item	Description
[Protocol Settings]	<p>Set whether to receive documents using the Raw Port.*¹</p> <p>Value: Off, On</p>
[Available Network]	<p>Set whether to enable this function for each network of Wi-Fi Direct, Wi-Fi and wired.</p> <p>Value: [Disable], [Enable]</p>

[IPP]

Item	Description
[Protocol Settings]	Set whether to send documents using IPP. To use it, select On in these settings, and select [Off] in [TLS] from "SecuritySettings". Then select [Not Secure (IPPS & IPP)] in the security settings from Command Center RX. The default port number is 631. Value: Off, On, 1 to 32767 (Port Number)
[Available Network]	Set whether to enable this function for each network of Wi-Fi Direct, Wi-Fi and wired. Value: [Disable], [Enable]

[IPP over TLS]

Item	Settings
[Protocol Settings]	Sets whether to receive documents using TLS-protected IPP. To use it, select On in these settings, and select [On] in [TLS] from "SecuritySettings". The factory default port number is 443.*1*2 Value: Off, On, 1 to 32767 (Port Number)  NOTE When the setting is On, TLS certificate is required. The factory certificate is the certificate owned by the machine.
[Available Network]	Set whether to enable this function for each network of Wi-Fi Direct, Wi-Fi and wired. Value: [Disable], [Enable]

[HTTP]

Item	Description
[Protocol Settings]	Set whether to communicate using HTTP.*1 Value: Off, On
[Available Network]	Set whether to enable this function for each network of Wi-Fi Direct, Wi-Fi and wired. Value: [Disable], [Enable]

[HTTPS]

Item	Description
[Protocol Settings]	Select whether to communicate using HTTPS.*1*2 Value: Off, On
[Available Network]	Set whether to enable this function for each network of Wi-Fi Direct, Wi-Fi and wired. Value: [Disable], [Enable]

[LDAP]

Select whether to use LDAP.

Value: Off, On

[SNMPv1/v2c]

Item	Description
[Protocol Settings]	Select whether to communicate using SNMP.* ¹ Value: Off, On
[Available Network]	Set whether to enable this function for each network of Wi-Fi Direct, Wi-Fi and wired. Value: [Disable], [Enable]

[SNMPv3]

Item	Description
[Protocol Settings]	Set whether to communicate using SNMPv3.* ¹ Value: Off, On
[Available Network]	Set whether to enable this function for each network of Wi-Fi Direct, Wi-Fi and wired. Value: [Disable], [Enable]

[Enhanced WSD]

Item	Description
[Protocol Settings]	Set whether to use our proprietary web services.* ¹ Value: Off, On  NOTE If you select [Off], the WIA driver, TWAIN driver, and Network FAX driver are not available.
[Available Network]	Set whether to enable this function for each network of Wi-Fi Direct, Wi-Fi and wired. Value: [Disable], [Enable]

[Enhanced WSD over TLS]

Item	Description
[Protocol Settings]	Set whether to use our proprietary Web service on TLS. ^{*1*2} Value: Off, On  NOTE If you select [Off], the WIA driver, TWAIN driver, and Network FAX driver are not available.
[Available Network]	Set whether to enable this function for each network of Wi-Fi Direct, Wi-Fi and wired. Value: [Disable], [Enable]

[eSCL]

Item	Description
[Protocol Settings]	Sets whether to receive scanned documents using eSCL. ^{*1} Value: Off, On
[Available Network]	Set whether to enable this function for each network of Wi-Fi Direct, Wi-Fi and wired. Value: [Disable], [Enable]

[eSCL over TLS]

Item	Description
[Protocol Settings]	Sets whether to receive scanned documents using TLS-protected eSCL. Value: Off, On
[Available Network]	Set whether to enable this function for each network of Wi-Fi Direct, Wi-Fi and wired. Value: [Disable], [Enable]

[VNC (RFB)]

Item	Description
[Protocol Settings]	Set when using a remote operation by starting up a VNC Viewer other than ours (example: Real VNC). The default port number is 9062. ^{*1} Value: [Off], [On], 1 to 32767 (Port Number)
[Available Network]	Set whether to enable this function for each network of Wi-Fi Direct, Wi-Fi and wired. Value: [Disable], [Enable]

[VNC (RFB) over TLS]

Item	Description
[Protocol Settings]	<p>Set when using a remote operation protected by TLS by starting up a VNC Viewer other than ours (example: Real VNC). The default port number is 9063.*¹*²</p> <p>Value: [Off], [On], 1 to 32767 (Port Number)</p> <hr/> <p> NOTE</p> <p>When the setting is On, TLS certificate is required. The factory certificate is the certificate owned by the machine.</p> <hr/>
[Available Network]	<p>Set whether to enable this function for each network of Wi-Fi Direct, Wi-Fi and wired.</p> <p>Value: [Disable], [Enable]</p>

[Enhanced VNC (RFB) over TLS]

Item	Description
[Protocol Settings]	<p>Start Command Center RX and set for using TLS-protected remote operation. The default port number is 9061.*¹*²</p> <p>Value: [Off], [On], 1 to 32767 (Port Number)</p> <hr/> <p> NOTE</p> <ul style="list-style-type: none"> • The factory default setting is [On]. • When the setting is On, TLS certificate is required. The factory certificate is the certificate owned by the machine. <p>➔ Command Center RX User Guide</p> <hr/>
[Available Network]	<p>Set whether to enable this function for each network of Wi-Fi Direct, Wi-Fi and wired.</p> <p>Value: [Disable], [Enable]</p>

*1 The setting will be changed after restarting the device or network.

*2 In "SecuritySettings" set [TLS] to [On].

➔ [TLS \(page 510\)](#)

 **IMPORTANT**

Depending on the protocol, it may be necessary to restart the network or turn the power off/on after changing the settings.

Ping

[System Menu / Counter] key > [NetworkSettings] > "Network Settings" [Ping]

Item	Description
[Ping]	<p>Check if you can communicate with the destination by entering the host name or IP address of the destination.</p> <hr/> <p> NOTE</p> <p>This function is not displayed when [Primary Network (Client)] is specified in [Optional Network].</p> <p>➔ Primary Network (Client) (page 500)</p> <hr/>
[Ping Timeout]	➔ Ping Timeout (page 424)

Bonjour

[System Menu / Counter] key > [NetworkSettings] > "Network Settings" [Bonjour]

Item	Description
[Protocol Settings]	<p>Select whether to use Bonjour.</p> <p>Value: Off, On</p>
[Available Network]	<p>Set whether to enable this function for each network of Wi-Fi Direct, Wi-Fi and wired.</p> <p>Value: [Disable], [Enable]</p>

IP Filter (IPv4)

[System Menu / Counter] key > [NetworkSettings] > "Network Settings" [IP Filter (IPv4)]

Item	Description
[IP Filter (IPv4)]	<p>Configure the IP Filter Setting. IP Filter is a function to restrict the access to the machine by the IP address and protocol.</p> <p>The IP address or network address of permitted hosts is set from Command Center RX. Not setting the IP Filter will allow access from all hosts.</p> <p>Value: [Off], [On]</p> <p>➔ Command Center RX User Guide</p>

IP Filter (IPv6)

[System Menu / Counter] key > [NetworkSettings] > "Network Settings" [IP Filter (IPv6)]

Item	Description
[IP Filter (IPv6)]	<p>Configure the IP Filter Setting. IP filter is a function used to restrict the access to the machine by setting the IP address and protocol.</p> <p>The IP address or network address of permitted hosts is set from Command Center RX. Not setting the IP Filter will allow access from all hosts.</p> <p>Value: [Off], [On]</p> <p>➔ Command Center RX User Guide</p>

IPSec

[System Menu / Counter] key > [NetworkSettings] > "Network Settings" [IPSec]

Item	Description
[IPSec]	<p>Set whether or not you use the IPSec.</p> <p>Value: [Off], [On]</p>

Restart the network

[System Menu / Counter] key > [NetworkSettings] > "Network Settings" [Restart Network]

Item	Description
[Restart Network]	Restarts the network.

Optional Network

[System Menu / Counter] key > [NetworkSettings] > "Optional Network"

Configure settings for the optional Network Interface Kit.

NOTE

This Menu is displayed when the optional Network Interface Kit or Wireless Network Interface Kit is installed.

Host Name

Check the host name of the machine. Host name can be changed from Command Center RX.

→ [Changing Device Information \(page 124\)](#)

Wireless Network

Configure settings for the optional Wireless Network Interface Kit.

NOTE

This function will be displayed when the optional Wireless Network Interface Kit (IB-51) is installed.



[Connection Status]

If you have the optional Wireless Network Interface Kit installed, you can check the status of your wireless LAN.

[Setup]

Item	Description
[Available Network]	Select access points to which the machine can be connected, enter the Preshared Key and start a connection.
[Push Button Method]	<p>If the access point supports the push button method, wireless settings can be configured using the push button. This setting executes push button, and the connection is started by pressing the push button on the access point.</p> <hr/> <p> NOTE</p> <p>The push button method supports only the WPS.</p> <hr/>
[PIN Code Method (Device)]	Starts connection using the machine's PIN code. Enter the PIN code into the access point. The PIN code of the machine is automatically generated.
[PIN Code Method (Terminal)]	Starts connection using the access point's PIN code. Enter the PIN code of the access point.
[Custom Setup]	The detailed settings for wireless LAN can be changed.

[Custom Setup]

Item	Description
[Network Name (SSID)]	<p>Set the SSID (Service Set Identifier) of the wireless LAN to which the machine connects.</p> <hr/> <p> NOTE</p> <p>Up to 32 characters can be entered.</p> <hr/>
[Connection Mode]	<p>Set Connection Mode. Value: [Ad Hoc], [Infrastructure]</p> <hr/> <p> NOTE</p> <p>[Ad Hoc]</p> <p>Directly communicates with the device without going through an access point. This method cannot be used to connect to two or more devices.</p> <p>[Infrastructure]</p> <p>Performs communication through an access point.</p> <hr/>
[Channel]	<p>Performs channel configuration. Use [-][+] or the numeric keys to set the value. Value: 1 to 11</p>
[Network Authentication]	<p>Select network authentication type. To select other options, open the device home page from a computer. Value: [Open], [Shared], [WPA-PSK]^{*1}, [WPA2-PSK]^{*1} ^{*1} Not displayed when [Ad Hoc] is specified in [Connection Mode].</p>
[Encryption]	<p>Select encryption method. If you selected a setting other than [Disabled], enter the WEP key or preshared key. The setting values vary depending on the Network Authentication setting. Select [Data Encryption].</p> <ul style="list-style-type: none"> • If the network authentication type is [Open] or [Shared] Value: [Disabled], [WEP] • If the network authentication type is [WPA-PSK] or [WPA2-PSK] Value: [TKIP]^{*2}, [AES], [Auto]^{*2}, [Preshared Key] <p>^{*2} Not displayed when [WPA2-PSK] is specified in [Network Authentication].</p> <hr/> <p> NOTE</p> <ul style="list-style-type: none"> • If you selected [WEP], enter the WEP key. Up to 26 characters can be entered. • If you selected [TKIP], [AES], or [Auto], enter the pre-shared key. 8 to 64 characters can be entered. <hr/>

[TCP/IP Settings]

For the setting values, refer to the following:

- ➔ [TCP/IP SettingsTCP/IP Settings \(page 484\)](#)
- ➔ [Bonjour \(page 494\)](#)
- ➔ [IPSec \(page 495\)](#)

[Others]

For the setting values, refer to the following:

- ➔ [NetWare \(page 498\)](#)
- ➔ [AppleTalk \(page 498\)](#)
- ➔ [MAC Address Filter \(page 499\)](#)

Wired Network Settings (Optional Network)

NOTE

This function will be displayed when the optional Network Interface Kit (IB-50) is installed.

[TCP/IP Settings]

For values, refer to the following:

- ➔ [TCP/IP SettingsTCP/IP Settings \(page 484\)](#)
- ➔ [Bonjour \(page 494\)](#)
- ➔ [IPSec \(page 495\)](#)

[Others]

Item	Description
[NetWare]	Use NetWare to receive documents. ➔ Network Interface Kit Operation Guide Value: [Off], [On]
[AppleTalk]	Set whether to receive documents using the AppleTalk. The setting will be changed after restarting the device or the machine's network. Value: [Off], [On]
[LAN Interface]	Select the LAN interface. The setting will be changed after restarting the device or the machine's network. Value: [Auto], [10BASE-T Half], [10BASE-T Full], [100BASE-TX Half], [100BASE-TX Full], [1000BASE-T]  NOTE This function will be displayed when the optional Network Interface Kit is installed.

Item	Description
[MAC Address Filter]	Set whether to use MAC Address Filter. ➔ Network Interface Kit Operation Guide Value: [Off], [On]

Restarting the Network

Item	Description
[Restart Network]	Restarts the network.



Connectivity

[System Menu / Counter] key > [NetworkSettings] > "Connectivity"

[Bluetooth Settings]

Item	Description
[Bluetooth]	Bluetooth keyboard is used. Value: Off, On
[Device]	Select a keyboard.

[Fax Server]

Item	Description
[Fax Server]	Select whether to use the Fax Server. Value: [Off], [On]
[Address Settings]	Set the prefix, suffix and domain name to attach to the destination.  NOTE For information about the fax server, contact the fax server administrator.
[File Format]	Set the default type of the files. Value: [PDF], [TIFF], [XPS]
[Address Book Type]	Set an external address book.  NOTE <ul style="list-style-type: none"> • This function is displayed when [Fax Server] is set to On. • This display does not appear if the external address book is not set. ➔ Command Center RX User Guide

[Remote Operation]

Configures remote operation settings.

Value: Off, On

If you select On, set the restriction.

Value: [Off], [Use Password], [Administrator Only]

If you selected Off, users with no administrator privileges can perform remote operation.

If you selected [Use Password], enter the password for remote operation.

If you selected [Administrator Only], only administrators can perform remote operations.

NOTE

If you selected [Administrator Only], remote operation from VNC software is not possible.

Others

[System Menu / Counter] key > [NetworkSettings] > "Others"

NOTE

This function is displayed when the optional Network Interface Kit (IB-50) or Wireless Network Interface Kit (IB-37/IB-38/IB-51) is installed.

The Wireless Network Interface Kit (IB-37 or IB-38) is an option for some models. Contact your dealer or our sales or service representatives for detail.

Item	Description
[Primary Network (Client)]	<p>Select the network interface to be used for the send function that this machine functions as a client, the network authentication and connecting to external address book.</p> <p>Value: [Wi-Fi], [Wired Network], [Optional Network]</p> <ul style="list-style-type: none"> • [Wi-Fi] is displayed when the optional Wireless Network Interface Kit (IB-37/IB-38) is installed. • [Optional Network] is displayed when the optional Network Interface Kit (IB-50) or Wireless Network Interface Kit (IB-51) is installed. • E-mails can be set and used separately by "[Wired Network] or [Wi-Fi]", and, "[Optional Network] (IB-50 or. IB-51)".
[Restart Entire Device]	<p>You can restart the device without turning the power switch off. Use this to deal with any unstable operation by the machine. (Same as the computer restart.)</p>

SecuritySettings

Configures security settings.

Security Quick Setup

[System Menu / Counter] key > [SecuritySettings] > [Security Quick Setup]

Item	Description
[Security Quick Setup]	<p>Select security settings from levels 1 to 3 that are close to your environment, and change (customize) the functions as needed.</p> <p>Value</p> <p>[Level 1] The factory default setting.</p> <p>[Level 2] The security function of the network will change.</p> <p>[Level 3] All functions that protect the machine are enabled, and functions that do not protect the machine are disabled.</p> <hr/> <p> NOTE</p> <ul style="list-style-type: none"> • This function can be set only when logged in with administrator privileges. ➔ Log in as Machine Administrator or Administrator (page 117) • Restart the device or network after selecting a level for the settings to take effect. ➔ Restart Entire Device (page 500) ➔ Restarting the Network (page 499) • If you change the security settings after selecting a level, the security quick setups will show as "Custom". • For more information on each security level setting, refer to the following: ➔ Security Quick Setup Function List (page 771)

Configuring Security Quick Setup

1 Display the screen.

- 1 [System Menu / Counter] key > [SecuritySettings] > [Security Quick Setup]
-



NOTE

If the user authentication screen appears, log in with a user who has the privilege to configure this setting. If you do not know your login user name or password, please contact your administrator.

2 Select the security level according to the usage environment.

3 Configure the security function as necessary.



NOTE

Refer to the following for the settings of each security level.

- ➔ [Security Quick Setup Function List \(page 771\)](#)
-



4 Restart the device or network.

- ➔ [Restart Entire Device \(page 500\)](#)
- ➔ [Restarting the Network \(page 499\)](#)

Interface Block Setting



[System Menu / Counter] key > [SecuritySettings] > "Interface Block Setting"

This allows you to protect this machine by blocking the interface with external devices such as USB hosts or optional interfaces.

Item	Description
[USB HOST]	This locks and protects the USB port (USB host). Value: [Unblock], [Block]
[USB Device]	This locks and protects the USB interface connector (USB Device). Value: [Unblock], [Block]
[USB Drive]	This locks and protects the USB memory slot. Value: [Unblock], [Block] <hr/>  NOTE This function can be configured when the USB host is set to [Unblock]. <hr/>
[Optional Interface]	This locks and protects the optional interface slots. Value: [Unblock], [Block] <hr/>  NOTE This function can be set at each Option Interface. <hr/>
[Restart Entire Device]	Restart the machine without turning the power switch off. <hr/>  IMPORTANT Restart the Device or turn the power off and on to reflect the change in the "Interface Block Setting". <hr/>

Device Security Settings

[System Menu / Counter] key > [SecuritySettings] > "Device Security Settings"

Item	Description
[Unusable Time]	Set a time period during which the machine will not print received faxes. This item is displayed for fax-compatible machines. ➔ FAX Operation Guide
[Job Status/Job Logs Settings]	➔ Job Status/Job Logs Settings (page 473)
[Security Level]	Specify the security level. Value [Low] This mode is used during maintenance. Do not use normally. [High] This is the security setting we recommend. Normally use this setting. [Very High] In addition to the [High] state, disables changing of machine settings with external commands. <hr/>  NOTE This function can be set only when logging in with the authority of the device administrator. ➔ Adding a User (Local User List) (page 524)
[Remote Printing]	➔ Remote Printing (page 469)
[RAM Disk Setting]	Create a RAM disk and set its capacity. You can print print data from the job box by creating a RAM disk. [RAM Disk Size] Value: Off, On <hr/>  NOTE <ul style="list-style-type: none"> • If On is selected, set the size. Setting range varies depending on size of onboard memory and optional memory usage. • This feature does not appear if the optional SSD is installed. <hr/>  IMPORTANT After changing the setting, restart the system or turn the machine OFF and then ON.

Item	Description
[Software Verification]	Verify the software in the machine. Select [Start] to run the verification. If you experience any abnormalities in software verification, contact your service representative.
[Administrator Authentication on Firmware Update]	Request administrator to approve when updating firmware. Value: [Off], [On]
[Allowlisting]	<p>In case if the unauthorized program or the program that has tampered are installed, the stored data or the contents of the communication in this program might be stolen. Once this function is activated, execution of the unauthorized software or the tampering of the software can be prevented, and possible to maintain the reliability of the system. Value: [Off], [On]</p> <hr/> <p> NOTE</p> <ul style="list-style-type: none"> • After setting it to [On], you need to shutdown and restart the machine. • Enabling this feature slows the machine start-up. • If malware is detected, an event report can be used as a way to understand its content. The Event reports can be enable by the Command Center RX > "Management Settings: Notification/Report" > [Recipient 1 E-mail Address] to [Recipient 3 E-mail Address] and [Notify when Malicious Program is Detected] is set to [On].
[Administrator Authentication on Data Import/Export]	Request approval from the administrator when importing/exporting data. Value: [Off], [On]

[Data Security]

[System Menu / Counter] key > [SecuritySettings] > "Device Security Settings" [Data Security]



Configure settings related to data stored in SSD or memory.

[SSD Initialization]

Change the security feature settings.

NOTE

- This feature appears when an optional SSD is installed and the optional security kit is running.
- To change security feature settings, you must enter a security password. The factory default value is 000000.

Item	Description
[Security Password]	<p>Customize the security password so that only the administrator can use the Data Encryption/Overwrite.</p> <p>Enter a new security password 6 to 16 alphanumeric characters and symbols.</p> <p>Enter the password again for confirmation.</p> <hr/> <p> IMPORTANT</p> <p>Avoid any easy-to-guess numbers for the security password (e.g. 11111111 or 12345678).</p>
[System Initialization]	<p>You can completely erase the contents of the SSD. Do so when you want to stop using the machine.</p> <hr/> <p> IMPORTANT</p> <p>If the power switch is turned off during initialization, the SSD may be damaged and the initialization may not complete.</p> <hr/> <p> NOTE</p> <p>If you accidentally turn the power switch off during initialization, turn the power switch on again. Initialization automatically restarts.</p>

[Data Sanitization]

This function returns the following information stored in the machine to the factory default.

- Address Book
- Favorite Data
- System Settings
- Fax Send/Receive/Transfer Data
- Outgoing and Incoming Fax Log
- Local Fax Station Name

- Local Fax Station Number
- Data in the Custom Box
- Optional applications

 **NOTE**

- Print "Data Sanitization Report" and check that security data has definitely been erased.
 - ➔ [Data Sanitization Report \(page 444\)](#)
- You cannot cancel a process in the middle.
- Disconnect any modular or network cables before performing this operation.
- Before executing this function, set all [Interface Block Setting] to [Unblock].
 - ➔ [Interface Block Setting \(page 503\)](#)
- Do not turn off the power during data sanitization. If the power is turned off during erasing, erasing will be performed automatically after the power is turned on, but complete operation cannot be guaranteed.

Item	Settings
[Run Immediately]	Execute security data sanitization.
[Reserve a Sanitization Time]	The address information and image data in the machine will be completely erased at the specified time. Value: [On], [Off] If you select [On], set the date and time for complete erasure. Value: Year (2000 to 2035), Month (1 to 12), Day (1 to 31), and Hour (0 to 23).
[Device Use After Sanitization]	After data sanitization, the usage of this machine will be restricted. If [Prohibit] is selected, machine operation is disabled. Value: [Permit], [Prohibit]
[Data Sanitization Report]	Prints the data sanitization report.

Items to be deleted

Classification	Data to be deleted
Device/Job	<ul style="list-style-type: none"> • The job settings set by the user • Network Settings • Image data saved in the document box • Data registered in One-Touch key • Jobs History • User information (user list, address book, document box registered by the user) • Account information of job accounting • Network certificate • Initial screen on machine changed by service representative

Classification	Data to be deleted
Fax (only for fax-compatible models)	<ul style="list-style-type: none"> • Fax settings configured by users • Communication restriction settings • Encryption key settings • Transmission histories • Scheduled Job • Conditional reception/forwarding settings
Application/program	<ul style="list-style-type: none"> • Application/favorite added by a user or service representative • Trial function

[OCR Dictionary Installation]

[System Menu / Counter] key > "SecuritySettings" > [Device Security Settings] "OCR Dictionary Installation"
Install the OCR Dictionary.

NOTE

- For information on dictionary data, contact your dealer or service representative.
- You need to install an SSD or an SD/SDHC memory card in order to install the OCR Dictionary.
- If an SSD and an SD/SDHC memory card are installed, the OCR Dictionary will be installed on the SSD.
- If using an SD/SDHC memory card, a 32 GB SDHC memory card is recommended.

Authentication Security

[System Menu / Counter] key > [SecuritySettings] > "Authentication Security"

Configure security settings for User Authentication.

➔ [Authentication Security \(page 522\)](#)

Unknown User Settings

[System Menu / Counter] key > [SecuritySettings] > "Unknown User Settings"

This specifies the behavior for handling the jobs sent with unknown or unsend login user names or User ID.



NOTE

This function is displayed when User Login Administration or Job accounting is set to On.

➔ [Unknown User Settings \(page 572\)](#)

Network

[System Menu / Counter] key > [SecuritySettings] > "Network"

Item	Description
[TLS]	Set whether to use TLS for communication. Value: [Off], [On]
[Network Access]	Set whether to use SNMP or IPsec for communication. ➔ SNMPv1/v2c (page 491) ➔ SNMPv3 (page 491) ➔ IPsec (page 495)

Job Accounting/Authentication

[System Menu / Counter] key > [Job Accounting/Authentication]

Configures settings related to machine management.

- ➔ [Overview of User Login Administration \(page 519\)](#)
- ➔ [Overview of Job Accounting \(page 550\)](#)
- ➔ [Unknown User Settings \(page 572\)](#)

Add/DeleteApplication

[System Menu / Counter] key > [Add/DeleteApplication]

Configure the application settings.

➔ [Using Applications \(page 238\)](#)

➔ [Overview of the Applications \(page 746\)](#)

Adjustment/Maintenance

Adjust printing quality and conduct machine maintenance.

Image Adjustment

[System Menu / Counter] key > [Adjustment/Maintenance] > "Image Adjustment"

[Density Adjustment]

Make the overall density darker or lighter.

Item	Description
[Copy]	Adjust copy density. Adjustment can be made in 7 levels. Value: -3 (Lighter), -2, -1, 0 (normal), +1, +2, +3 (Darker)
[Send/Box]	Adjust scan density when sending or storing the data in Document Box. Adjustment can be made in 7 levels. Value: -3 (Lighter), -2, -1, 0 (normal), +1, +2, +3 (Darker)
[Fax]	This item is displayed for fax-compatible machines. ➔ FAX Operation Guide

[Clarify Text (Noise Removal) Settings]

Adjust the legibility of characters.

Item	Description
[Clarify Text Level]	Value: [1 (Low)], [2 (Normal)], [3 (High)]
[Noise Removal Level]	Value Off On: [1 (Low)], [2 (Normal)], [3 (High)]

[Background Density Adj.]

Make the overall background darker or lighter.

Item	Description
[Copy (Auto)]	Darkens or lightens overall background density adjustment during copying. Adjustment can be made in 7 levels. Value: -3 (Lighter), -2, -1, 0 (normal), +1, +2, +3 (Darker)
[Send/Box (Auto)]	Darkens or lightens overall background density when sending images or storing them in the Document Box. Adjustment can be made in 7 levels. Value: -3 (Lighter), -2, -1, 0 (normal), +1, +2, +3 (Darker)

[Sharpness Adjustment]

Adjusts the sharpness of image outlines.

Item	Description
[Copy]	Sharpen or blur overall image outlines during copying. Adjustment can be made in 7 levels. Value: -3 (Blur), -2, -1, 0, +1, +2, +3 (Sharpen)
[Send/Box]	Sharpen or blur overall image outlines when sending or storing them in the Document Box. Adjustment can be made in 7 levels. Value: -3 (Blur), -2, -1, 0, +1, +2, +3 (Sharpen)

[Contrast]

Make the overall contrast higher or lower.

Item	Description
[Copy]	Increases or decreases the overall contrast of copies. Value: -3 (Lower), -2, -1, 0 (normal), +1, +2, +3 (Higher)
[Send/Box]	Increases or decreases the overall contrast when documents are sent or saved in a document box. Value: -3 (Lower), -2, -1, 0 (normal), +1, +2, +3 (Higher)

[Toner SaveLevel (EcoPrint)]

Item	Description
[Copy]	Select the default Toner Save Level (EcoPrint). Value: 1 to 5 Raising the level reduces toner consumption, but image quality falls.
[Printer]	Select the default Toner Save Level (EcoPrint). Value: 1 to 5 Raising the level reduces toner consumption, but image quality falls.

[Auto Color Correction]

This setting allows you to adjust the detection level used by the machine to determine whether the original is color or black and white in Auto Color Selection Mode. Setting a lower value will result in more originals being identified as color, while a larger value will tend to increase the number of originals being identified as black and white.

Value: 1 (color), 2,3,4,5 (black and white)

[Correcting Black Line]

Correct fine lines (streaks caused by contamination), which may appear on the image, when the document processor is used.

Value: [Off], [On]

[Color Registration - Auto]

When first installing the machine or moving it to a new location, color drift during printing may occur. Use this function to correct the color position of each of cyan, magenta and yellow to resolve color drift.

➔ [Color Registration Procedure \(page 720\)](#)

[Color Registration - Manual]

When first installing the machine or moving it to a new location, color drift during printing may occur. Use this function to correct the color position of each of cyan, magenta and yellow to resolve color drift.

➔ [Color Registration Procedure \(page 720\)](#)

[Image Adjustment]

You can select the one you need from drum refresh, development refresh, laser scan cleaning, and calibration and execute it continuously.

Drum Refresh

Remove image blur and white dots from the printout. It takes about 1 minute and 20 seconds. The time required may vary depending on the usage environment.

Developer Refresh

Adjust the printed image that is too light or incomplete, even though there is enough toner.

Laser Scanner Cleaning

Remove vertical white lines from the printout.

Calibration

Calibrate the device to ensure correct toner overlapping and consistency with the original tone.

➔ [Perform image adjustment \(page 724\)](#)

NOTE

- Drum refresh cannot be performed while printing. Execute drum refresh after the printing is done.
- Waiting time may be longer when the toner is refilled during developer refresh.
- When correct toner overlapping is not ensured even after performing calibration, refer to the following:

➔ [Color Registration Procedure \(page 720\)](#)

Others

[System Menu / Counter] key > [Adjustment/Maintenance] > "Others"

[Optional Memory]

When the optional memory is installed, select the memory distribution pattern according to the application.

Value: [Printer Priority], [Standard], [Copy Priority]

IMPORTANT

After changing the setting, restart the system or turn the machine OFF and then ON.

[Altitude Adjustment]

Adjust the height.

Value: [Normal], [1001 - 2000m], [2001 - 3000m], [3001 - 3500m]

[MC]

Set MC.

Value: 1 to 7

[GS]

Set GS.

Value: 1 to 7

[Diagnostics]

Item	Description
[Memory Diagnostics]	Execute this when you diagnose the machine memory.

[Test Page]

Output the test page for identifying the cause of the image defects.

[Restart/Initialization]

Item	Description
[Restart Network]	➔ Restart the network (page 495)
[Restart Network (Optional Network)]	➔ Restart the network (page 495)
[Restart Entire Device]	➔ Restart Entire Device (page 500)
[Format SSD]	Format the SSD.
[Format SD Card]	Format the SD card. To use an SD card, it is necessary to format the SD card on this machine first. When the formatting is complete, data can be written to the SD card.

[Service Settings]

Perform the maintenance and inspection of the machine. This menu is primarily used by service personnel for maintenance work.

9 User Authentication and Accounting (User Login, Job Accounting)

Overview of User Login Administration

User login administration specifies how the user access is administered on this machine. Enter a correct login user name and password for user authentication to login.

- 1 Enable User Login Administration
 - ➔ [Enable User Login Administration \(page 521\)](#)
- 2 Set the user
 - ➔ [Setting User Login Administration \(page 522\)](#)
- 3 Enter the login user name and password and execute the job
 - ➔ [Login \(page 76\)](#)

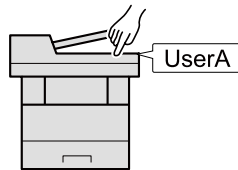

Managing the Job Account from PC

In addition to the above settings, the following are necessary to manage the job account from PC.

To Manage the Users to Print from PCs

Printer driver settings are necessary to manage the users that print on the machine from PCs.

- ➔ [Managing the Users that Print on This Machine from a PC \(page 528\)](#)

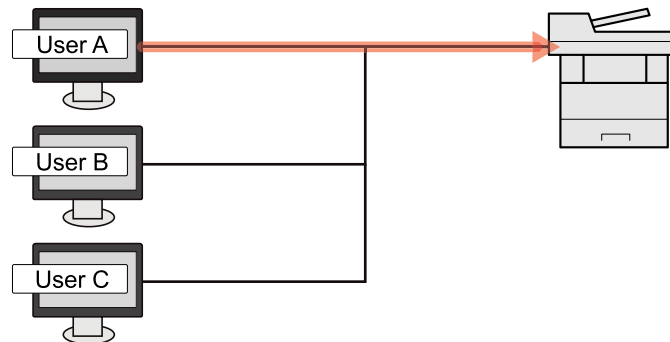

Managing the Users to Use TWAIN for Scanning

TWAIN driver settings on the PC are necessary to manage the users that use TWAIN for scanning.

- ➔ [Managing the Users to Scan Using TWAIN \(page 530\)](#)

Managing the Users to Use WIA for Scanning

WIA driver settings on the PC are necessary to manage the users that use WIA for scanning.

- ➔ [Managing the Users to Scan Using WIA \(page 531\)](#)

Managing the Users that Send Faxes from a PC

FAX driver settings on the PC are necessary to manage the users that send faxes from a PC.

➔ [Managing the Users that Send Faxes from a PC \(page 532\)](#)

The fax function can be used on products equipped with fax capability.

Enable User Login Administration

This enables user login administration.

Select one of the following authentication methods:

Item	Description
[Local Authentication]	User authentication based on user properties on the local user list stored in the machine.
[Network Authentication]	User authentication based on Authentication Server. Use a user property stored in Authentication Server to access the network authentication login page.

1 Display the screen.

- 1 [System Menu / Counter] key > [Job Accounting/Authentication]



NOTE

If the user authentication screen appears, log in with a user who has the privilege to configure this setting. If you do not know your login user name or password, please contact your administrator.

- 2 Select [User Login] from "User Login Setting".

2 Configure the settings.

- Select [Local Authentication] or [Network Authentication].
- Select [Off] to disable user login administration.
- If [Local Authentication] is selected, set [Local Authorization].
 - ➔ [Local Authorization \(page 534\)](#)
- If [Network Authentication] is selected, set "Server Settings".
 - ➔ [Server Settings \(page 535\)](#)



NOTE

If you cannot login because of the setting of the machine, login with any administrator registered in the local user list and correct the settings.

Setting User Login Administration

This registers, alters and deletes users and configures the settings for User Login Administration.

Authentication Security

If user authentication is enabled, configure the user authentication settings.

User Account Lockout Setting

You can prohibit the use of a user account if an incorrect password is entered repeatedly to login with that account.

1 Display the screen.

- 1 [System Menu / Counter] key > [Job Accounting/Authentication] > "Authentication Security" [User Account Lockout Settings]



NOTE

If the user authentication screen appears, log in with a user who has the privilege to configure this setting. If you do not know your login user name or password, please contact your administrator.

2 Configure the settings.

Configurable items are as follows:

Lockout

Select whether or not account lockout policy is enabled.

Value: Off, On

[Lockout Policy]

Specify the conditions and the extent to which the account lockout is applied.

Value

Number of Retries until Locked: Specify how many login retries are allowed until the account is locked out. (1 to 10 times)

Lockout Duration: Specify how long the account is to be locked out until it is unlocked. (1 to 60 minutes)

Lockout Target: Specify the extent to which the account lockout is applied. You can select either [Remote Login Only] or [All]. Remote Login Only locks out all operations from outside the operation panel.

[Locked out Users List]

Displays a list of locked out users. You can unlock a user by selecting the user in the list, and selecting [Unlock].



NOTE

This function is displayed when account lockout policy is enabled.

Password Policy Settings

You can prohibit the setting and use of passwords that do not comply with the password policy. Setting the Password Policy makes it more difficult to break the password.

1 Display the screen.

- 1 [System Menu / Counter] key > [Job Accounting/Authentication] > "Authentication Security" [Password Policy Settings]



NOTE

If the user authentication screen appears, log in with a user who has the privilege to configure this setting. If you do not know your login user name or password, please contact your administrator.

2 Configure the settings.

Configurable items are as follows:

[Password Policy]

Select whether or not password policy is enabled.

Value: Off, On

[Minimum Password Length]

Set the minimum password length of characters for password.

Value: Off, On (1 to 64 characters)

[Password Complexity]

Set the password complexity.

Value

[No more than two consecutive identical char]: Off, On

[At least one uppercase letter (A-Z)]: Off, On

[At least one lowercase letter (a-z)]: Off, On

[At least one number (0 - 9)]: Off, On

[At least one symbol]: Off, On

[Maximum Password Age]

Set the maximum password age.

Value: Off, On (1 to 180 days)

[Policy Violated User List]

List of users who do not meet password policy requirements.

Adding a User (Local User List)

You can add up to 1000 users (including the default login user name).

1 Display the screen.

- 1 [System Menu / Counter] key > [Job Accounting/Authentication]



NOTE

If the user authentication screen appears, log in with a user who has the privilege to configure this setting. If you do not know your login user name or password, please contact your administrator.

- 2 Select [Add/Edit Local User] from "User Login Setting".

2 Enter the user information.

[Add] > Add information on each item

User Name*¹

Enter the name displayed on the user list (up to 32 characters).

Login User Name*¹

Enter the login user name to login (up to 64 characters). The same login user name cannot be registered.

Login Password*¹

Enter the password to login (up to 64 characters).

[Access Level Settings]*¹

Configure user privilege.

Access Level

Select [Administrator] or [User] for user access privileges.

System Administration Permissions

If the user privileges level set in Access Level is [User], select the items for which the user has setting privileges from the following:

- Original/Paper Settings
- Address Book
- User/Job Account Information
- Basic Network Settings
- Basic Device Settings
- Advanced Device/Network Settings

[Account Name]

Add an account where the user belongs. The user, who registered his/her account name, can login without entering the account ID.

➔ [Overview of Job Accounting \(page 550\)](#)



NOTE

- Search by account ID or account name. Select either [Search (ID)] or [Search(Kana)] to switch between [Search (ID)] and [Search(Kana)].
 - Select [Account Name] or [Account ID] to sort the account list.
-

Email Address

The user can register his/her E-mail address. Register if you wish to use E-mail sending. The registered address will be automatically selected for subsequent operations that need any E-mail function.

[ID Card Info]

Register ID card information. Place the ID card on the ID card reader.



NOTE

This function is displayed when the optional ID Card Authentication Kit is activated.

➔ [Card Authentication Kit\(B\) AC <IC card authentication kit \(Activate\)> \(page 744\)](#)

Local Authorization *2

Set usage authority for each user.

Print Restriction

Select whether or not use of the print function of the printer is prohibited. Applicable print functions are as follows:

- Print from Box
- Print from USB Drive
- Print Report
- Print from PC

Print Restriction (Color)

Select whether or not use of the print function (color) of the printer is prohibited. Applicable print functions are as follows:

- Print from Box
- Print from USB Drive
- Print Report
- Print from PC

Copy Restriction

Select whether or not use of the copy print function is prohibited.

Copy Restriction (Color)

Select whether or not use of the copy print function (color) is prohibited.

Copy Restriction (Full Color)

Select whether or not use of the copy print function (full color) is prohibited.

Duplex Restriction

Select whether only duplex printing is allowed.

Combine Restriction

Specify whether only Combine is allowed.

EcoPrint Restriction

Specify whether only EcoPrint is allowed.

Send Restriction

Select whether or not use of the send function is prohibited.

Fax TX Restriction

Select whether or not use of the fax send function is prohibited.

This item is displayed for fax-compatible machines.

Storing Restriction in Box

Select whether or not to reject usage of storing in the document boxes.

Displayed when the optional SSD is installed.

Storing Restr. in USB

Set whether or not to reject usage of storing in the USB drive.

[My Panel]

You can register the language selection, initial screen, and shortcut settings for each user. Settings registered here can be applied simply by logging in.

*1 Be sure to enter the items.

*2 Displayed when Local Authorization is enabled.

➔ [Local Authorization \(page 534\)](#)



NOTE

- For details on entering characters, refer to the following:
➔ [Character Entry Method \(page 748\)](#)
- If you selected [Send] or [Fax] in the Default Screen for My Panel, select [Destination], [Machine Address Book], or [External Address Book] as the screen to display.

3 Select [Register].

A new user is added on the local user list.



NOTE

If simple login is enabled, a confirmation screen appears when new registration is finished asking if you will configure simple login settings. To configure simple login settings, select [Yes]. If you select [No], you will return to the user list screen.

For the procedure for configuring simple login settings, refer to the following:

➔ [Simple Login Settings \(page 545\)](#)

Changing User Properties

Types of user properties that could be changed may be different depending on user access privilege.

1 Display the screen.

- 1 [System Menu / Counter] key > [Job Accounting/Authentication]



NOTE

If the user authentication screen appears, log in with a user who has the privilege to configure this setting. If you do not know your login user name or password, please contact your administrator.

- 2 Select [Add/Edit Local User] from "User Login Setting".

2 Change the user properties.

- 1 Select  (information icon) for the user whose properties you wish to change.



NOTE

- Select [User Name] or [Login User Name] to sort the user list.
 - Search by name or login user name. Select either [Search(Login)] or [Search(Name)] to switch between [Search(Login)] and [Search(Name)].
-

- 2 Check the settings and change or add information as needed.

- User Name
- Login User Name^{*1}
- [Domain Name]^{*3}
- Login Password
- [Access Level Settings]^{*1}
- [Account Name]^{*1}
- Email Address
- [ID Card Info]^{*1}
- Local Authorization^{*1*2}
- [My Panel]

*1 You can change only when you log in with machine administrator authority.

*2 Displayed when Local Authorization is enabled.

➔ [Local Authorization \(page 534\)](#)

For details on each item, refer to step 3 of "Adding a User (Local User List)" to change a user property.

➔ [Adding a User \(Local User List\) \(page 524\)](#)

*3 If the user is a network user with local user privileges, the Domain Name is displayed.

➔ [Configure Network User Rights \(page 536\)](#)

- 3 Select [Save].

The user information is changed.

Deleting a User

1 Display the screen.

- 1 [System Menu / Counter] key > [Job Accounting/Authentication]

 **NOTE**

If the user authentication screen appears, log in with a user who has the privilege to configure this setting. If you do not know your login user name or password, please contact your administrator.

- 2 Select [Add/Edit Local User] from "User Login Setting".

2 Deleting a user.

- 1 Select the user to delete.
- 2 [Delete] > [Delete]

The selected user will be deleted.

 **NOTE**

The default user with machine administrator rights cannot be deleted.

➔ [Administrator Privileges Overview \(page 117\)](#)

Managing the Users that Print on This Machine from a PC

To manage the users that print on this machine from a PC, the following settings are necessary in the printer driver. Instructions are based on interface elements as they appear in Windows 10.

1 Display the screen.

- 1 Select the Windows [Start] button → [Windows System Tool] → [Control Panel] → [Devices and Printers].

 **NOTE**

- For Windows 11, select the [Start] button → [All apps] → [Windows Tools] → [Control Panel] → [Devices and Printers].
 - For Windows 8.1, select [Settings] in the Charms Bar on Desktop → [Control Panel] → [Devices and Printers].
-

- 2 Right-click the printer driver icon of the machine, and click the [Printer properties] menu of the printer driver.
- 3 Click [Administrator] on the [Device Settings] tab.

2 Configure the settings.

- 1 Select [User Login] on the [User Login] tab.

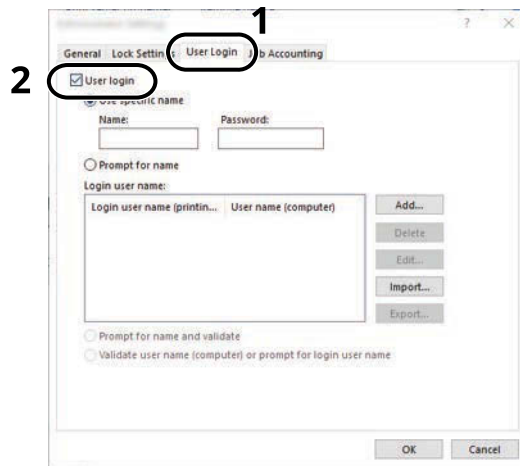

- 2 Set the User Login Administration.

[Use Specific Login User Name]

This option can be used to specify a user name and password to use the same User login for every print job. If this option is selected, the user does not have to type the name and password for each print job.

[Prompt for name]

A screen for entering the user name and password will be displayed when attempting a printing. The user name and password must be entered each time a printing is attempted.

[Prompt for name and validate]

A screen for entering the user name and password will be displayed when attempting a printing. The user name and password stored in the "Login user names list" needs to be entered. The user name and password must be entered each time a printing is attempted.

[Validate user name (computer) or prompt for login user name]

When printing, the Windows user name is searched in the "Login user names" and printing is possible if the name is registered. If the name is not registered, the printing will be canceled for users with only user authority. If the user has administrator privileges, the screen to enter the user name and password will appear.

- 3 Click [OK].



NOTE

For other settings of job accounting, refer to the following:

➔ **Printer Driver User Guide**

Managing the Users to Scan Using TWAIN

The following TWAIN driver settings are necessary to manage the users that use TWAIN for scanning. Instructions are based on interface elements as they appear in Windows 10.

1 Display the screen.

- 1 Click the search box in the taskbar, and enter "TWAIN Driver Setting". Select [TWAIN Driver Setting] in the search list. Displays the TWAIN Driver Settings screen.



NOTE

In Windows 8.1, Click [Search] in charms, and enter TWAIN Driver Setting in the search box. Select [TWAIN Driver Setting] in the search list.

- 2 Select the machine, and click [Edit].



2 Configure the settings.

- 1 Click [User Authentication Settings].
- 2 Select the checkbox beside [Authentication], and enter Login User Name and Password.



- 3 Click [OK].

Managing the Users to Scan Using WIA

The following WIA driver settings are necessary to manage the users that use WIA for scanning. Instructions are based on interface elements as they appear in Windows 10.

1 Display the screen.

- 1 Select the Windows [Start] button → [Windows System]→ [Control Panel]. Enter "Scanner" into the search field on the control panel. Select [View scanners and cameras] in the search list then the Scanners and Cameras screen appears.



NOTE

- For Windows 11, select the [Start] button → [All apps]→ [Windows Tools]→ [Control Panel]. Enter "Scanner" into the search field on the control panel. Select [View scanners and cameras] in the search list then the Scanners and Cameras screen appears.
- In Windows 8.1, click [Search] in the Charms Bar on Desktop, and enter "View scanners and cameras" in the search box. Click [View scanners and cameras] in the search list then the Scanners and Cameras screen appears.

- 2 Select the same name as this machine from WIA Drivers, and press [Properties].

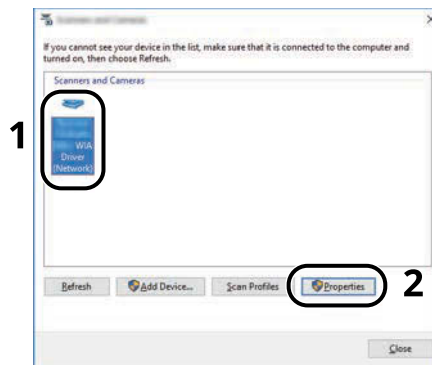

2 Configure the settings.

- 1 Select the checkbox beside [Authentication] on the [Settings] tab, and enter Login User Name and Password.

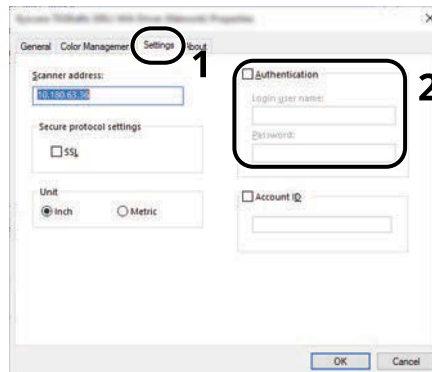

- 2 Click [OK].

Managing the Users that Send Faxes from a PC

To manage the users that send faxes from a PC, the following settings are necessary in the FAX driver. Instructions are based on interface elements as they appear in Windows 10.

1 Display the screen.

- 1 Select the [Start] button in Windows, select → [Windows System Tools], → [Control Panel] → [Devices and Printers].

NOTE

- For Windows 11, select the [Start] button → [All apps] → [Windows Tools] → [Control Panel] → [Devices and Printers].
- For Windows 8.1, select [Settings] in the Charms Bar on Desktop → [Control Panel] → [Devices and Printers].

- 2 Right-click the FAX driver icon of the machine, and click the [Printing preferences] menu of the FAX driver.
- 3 Click [FAX TX Setting] on the [Printing Preferences] tab.

2 Configure the settings.

- 1 Select [User Login] on the [Authentication] tab.

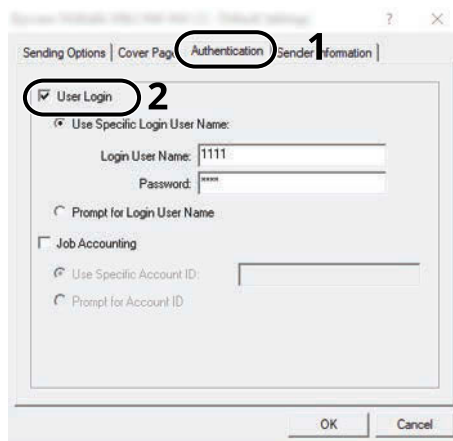

- 2 Set the User Login Administration.

[Use Specific Login User Name]

This option can be used to specify a user name and password to use the same User login for every FAX job. If this option is selected, the user does not have to type the name and password for each FAX job.

[Prompt for Login User Name]

A screen for entering the user name and password will be displayed when attempting a transmission. The user name and password must be entered each time a transmission is attempted.

- 3 Click [OK].

Local Authorization

Select whether or not to use Local Authorization.

NOTE

When using Local Authorization, the user authentication type must be set to [Local Authentication].

→ [Enable User Login Administration \(page 521\)](#)

1 Display the screen.

- 1 [System Menu / Counter] key > [Job Accounting/Authentication]
-

NOTE

If the user authentication screen appears, log in with a user who has the privilege to configure this setting. If you do not know your login user name or password, please contact your administrator.

- 2 Select [Local Authorization] from "User Login Setting".

2 Configure the settings.

- 1 Select [Off] or [On].

Server Settings

Set the server type when network authentication is enabled.

1 Display the screen.

- 1 [System Menu / Counter] key > [Job Accounting/Authentication]



NOTE

If the user authentication screen appears, log in with a user who has the privilege to configure this setting. If you do not know your login user name or password, please contact your administrator.

- 2 Select "User Login Setting" [User Login] > [Network Authentication].

2 Configure the settings.

- 1 Select [NTLM], [Kerberos] or [Ext.] as the "Server Type" and enter the host name (256 characters or less) for the Authentication Server.

When selecting [Ext.] as the server type, enter the port number.



NOTE

- Selecting [Add/Edit/Delete Domain] displays the domain registration list. In the domain registration list screen, select [Add/Edit], and enter the domain name. Up to 10 domain names can be registered.
 - If two or more domains are registered, select [Default Domain] and select the default domain.
-

- 2 Select [OK].



NOTE

If the login user name and password are rejected, check the following settings.

- Network Authentication setting of the machine
 - User property of the Authentication Server
 - Date and time setting of the machine and the Authentication Server
-

Configure Network User Rights

Select whether or not to grant local user rights to network users. If this setting is applied, when a network user logs in, the logged in network user's information is registered as a local user. By setting the account name on the registered local user information, network users can coordinate with job accounting. Displays the "Domain Name" in the user information for local users with rights.

NOTE

For local user information, refer to the following:

→ [Adding a User \(Local User List\) \(page 524\)](#)

1 Display the screen.

- 1 [System Menu / Counter] key > [Job Accounting/Authentication]

NOTE

If the user authentication screen appears, log in with a user who has the privilege to configure this setting. If you do not know your login user name or password, please contact your administrator.

- 2 Select [Network User Authority] from "User Login Setting".

2 Configure the settings.

Enable "Give Local User Authority" to configure the settings.

"User Full Action"

Configure the action when the number of users is exceeded when granting local user rights.

Value: [Do Not Add New User], [Delete Old User]

"Authority When Offline"

Set the expiration date for local user rights that have been granted and that do not require network authentication.

Value: [Always Enabled], [Specify Enabled Period] (up to 180 days)

[Local Authorization Defaults]

Set the default local user rights that are granted.

Group Authorization Settings

Set restrictions of the machine usage by each individual group registered in the authentication server.

NOTE

To use the group authorization settings, [Network Authentication] must be selected for the authentication method in "User Login Setting". In addition, set "LDAP" to ON in "Protocol Settings".

→ [Enable User Login Administration \(page 521\)](#)

→ [Protocol Settings \(page 488\)](#)

Group Authorization

1 Display the screen.

- 1 [System Menu / Counter] key > [Job Accounting/Authentication]
-

NOTE

If the user authentication screen appears, log in with a user who has the privilege to configure this setting. If you do not know your login user name or password, please contact your administrator.

- 2 Select [Group Authorization] from "User Login Setting".

2 Configure the settings.

- 1 Select [Off] or [On].

Group List (Up to 20)

Register the groups that are restricted the machine usage. Other users and groups belong to "Others".

1 Display the screen.

- 1 [System Menu / Counter] key > [Job Accounting/Authentication]
-

NOTE

If the user authentication screen appears, log in with a user who has the privilege to configure this setting. If you do not know your login user name or password, please contact your administrator.

- 2 Select [Group List] from [User Login Setting].

2 Configure the settings.

- 1 [Add] > add information on each item

Group Name

Enter the name displayed on the group list (up to 32 characters).

Group ID*1

Enter the ID displayed on the group list (between 1 and 4294967295).

Access Level

Select [Administrator] or [User] for group access privileges.

Print Restriction

Select whether or not use of the print function of the printer is prohibited. Applicable print functions are as follows:

- Print from Box
- Print from USB Drive
- Print Report
- Print from PC

Print Restriction (Color)

Select whether or not use of the print function (color) of the printer is prohibited. Applicable print functions are as follows:

- Print from Box
- Print from USB Drive
- Print Report
- Print from PC

Copy Restriction

Select whether or not use of the copy print function is prohibited.

Copy Restriction (Color)

Select whether or not use of the copy print function (color) is prohibited.

Copy Restriction (Full Color)

Select whether or not use of the copy print function (full color) is prohibited.

Duplex Restriction

Select whether only duplex printing is allowed.

Combine Restriction

Specify whether only Combine is allowed.

EcoPrint Restriction

Specify whether only EcoPrint is allowed.

Send Restriction

Select whether or not use of the send function is prohibited.

Fax TX Restriction

Select whether or not use of the fax send function is prohibited.

This item is displayed for fax-compatible machines.

Storing Restriction in Box

Select whether or not to reject usage of storing in the document boxes.

Displayed when the optional SSD is installed.

Storing Restr. in USB

Set whether or not to reject usage of storing in the USB drive.

*1 For "Group ID", specify PrimaryGroupID assigned by Active Directory of Windows.



NOTE

For details on entering characters, refer to the following:

➔ [Character Entry Method \(page 748\)](#)

3 Register the group.

- 1 Select [Save].

A new group is added on the group list.

Guest Authorization Settings

When User Login Administration is enabled, set the functions that guest users who cannot log in to the machine are allowed to use.

NOTE

To use Guest Authorization, [User Login] must be enabled in "User Login Setting".

→ [Enable User Login Administration \(page 521\)](#)

Enabling Guest Authorization

1 Display the screen.

- 1 [System Menu / Counter] key > [Job Accounting/Authentication]

NOTE

If the user authentication screen appears, log in with a user who has the privilege to configure this setting. If you do not know your login user name or password, please contact your administrator.

- 2 Select [Guest Authorization Set.] from "User Login Setting".

2 Configure the settings.

- 1 Select [Off] or [On].

NOTE

- If the guest authorization setting is enabled, the [Logout] must be selected when logging in.
 - In the guest user default settings, only monochrome copying can be used. If you wish to use a different function, log in as a user who can use that function, or change the settings in the guest properties.
-

Configuring Guest Property

Register guest user information and functions that are restricted.

1 Display the screen.

- 1 [System Menu / Counter] key > [Job Accounting/Authentication]

NOTE

If the user authentication screen appears, log in with a user who has the privilege to configure this setting. If you do not know your login user name or password, please contact your administrator.

- 2 Select [Guest Property] from "User Login Setting".

2 Configure the settings.

Check the settings and change or add information as needed.

User Name

Enter the name displayed on the user list (up to 32 characters). The default setting is "GuestUser".

Access Level

The authority of the user appears. This cannot be changed.

[Account Name]

Add an account where the user belongs.

If the user does not belong to any account, select [Others].

Authorization Rules

Set usage authority for each user.

The items you can restrict the access level with are as follows.

Print Restriction

Select whether or not to prohibit use of print functions for the printer.

Applicable print functions are as follows:

- Print from Box
- Print from USB Drive

Print Restriction (Color)

Select whether or not to prohibit use of the print function (color) of the printer.

Applicable print functions are as follows:

- Print from Box
- Print from USB Drive

Copy Restriction

Select whether or not to prohibit use of copy print functions.

Copy Restriction (Color)

Select whether or not to prohibit use of color copy functions.

Copy Restriction (Full Color)

Select whether or not use of the copy print function (full color) is prohibited.

Duplex Restriction

Select whether only duplex printing is allowed.

Combine Restriction

Specify whether only Combine is allowed.

EcoPrint Restriction

Specify whether only EcoPrint is allowed.

Send Restriction

Select whether or not to reject usage of the send functions.

Fax TX Restriction

Select whether or not to reject usage of the FAX transmissions.

This item is displayed for fax-compatible machines.

Storing Restriction in Box

Select whether or not to prohibit use of storing in the document boxes.

Storing Restr. in USB

Set whether or not to reject usage of storing in the USB drive.

3 Register the user.

- 1 Select [OK].

Obtain NW User Property

Set the required information to obtain the network user property from the LDAP server. The user name and E-mail address obtained with this setting is shown in the user information, the status confirmation screen, and the header of E-mail.

NOTE

To obtain the network user property from the LDAP server, [Network Authentication] must be selected for the user authentication method in "User Login Setting". In addition, set [LDAP] to On in "Protocol Settings".

→ [Enable User Login Administration \(page 521\)](#)

→ [Protocol Settings \(page 488\)](#)

1 Display the screen.

- 1 [System Menu / Counter] key > [Job Accounting/Authentication]

NOTE

If the user authentication screen appears, log in with a user who has the privilege to configure this setting. If you do not know your login user name or password, please contact your administrator.

- 2 Select [Obtain NW User Property] from "User Login Setting".

2 Configure the settings.

- 1 Enable "Obtain NW User Property" to configure the settings.

LDAP Server Information

Server Name*1

Enter the LDAP server name or the IP address (up to 64 characters). If a server name is not entered, user information will be acquired from the server set for Network Authentication.

Port

Port number for LDAP server. The default port number is 389.

Acquisition of User Information

Name 1*2

Enter the LDAP Attribute to obtain the user name to be displayed from the LDAP server (up to 32 characters).

Name 2*3

Enter the LDAP Attribute to obtain the user name to be displayed from the LDAP server (up to 32 characters).

Email Address*4

Enter the LDAP Attribute to obtain the E-mail address from the LDAP server (up to 256 characters).

Authentication Type *5

Set the authentication method. Select [Simple] or [SASL]. After changing the setting, restart the system or turn the power off and then on.

Search Timeout

Set the amount of time to wait before time-out in seconds (from 5 to 255 seconds).

LDAP Security

Select the type of encryption according to the type of security employed by the LDAP server. The value is [Off], [TLS] or [STARTTLS].

*1 If using Active Directory of Windows, the server name may be the same as the server name entered in the network authentication.

* 2 For Active Directory on Windows, typically use the displayName attribute.

*3. "Name 2" can be left out. When you assign "displayName" in "Name 1" and "department" in "Name 2", and if the value of displayName is "Mike Smith" and the value of department is "Sales" in Active Directory of Windows, the user name appears as "Mike Smith Sales".

*4 If using Active Directory of Windows, mail of Attribute may be used as E-mail Address.

*5. This function is displayed when "Server Type" is set to [Kerberos] in "Network Authentication".

3 Select [OK].

Simple Login Settings

The simple login function allows users to log in simply by selecting a user name. Users must be registered in advance to use this functionality.

NOTE

- For user registration, refer to the following:
 - ➔ [Adding a User \(Local User List\) \(page 524\)](#)
 - To use Simple Login, User Login Administration must be enabled in "User Login Setting".
 - ➔ [Enable User Login Administration \(page 521\)](#)
 - When the guest authorization setting is enabled, the Simple Login screen is not displayed.
-

Enabling Simple Login

1 Display the screen.

- 1 [System Menu / Counter] key > [Job Accounting/Authentication]
-

NOTE

If the user authentication screen appears, log in with a user who has the privilege to configure this setting. If you do not know your login user name or password, please contact your administrator.

- 2 Select [Simple Login] from "User Login Setting".

2 Configure the settings.

- 1 Select [Off] or [On].

Simple Login Key

Register users to use simple login. You can add up to 20 users.

1 Display the screen.

- 1 [System Menu / Counter] key > [Job Accounting/Authentication]
-

NOTE

If the user authentication screen appears, log in with a user who has the privilege to configure this setting. If you do not know your login user name or password, please contact your administrator.

- 2 Select [Simple Login Key] from "User Login Setting".

2 Enter the user information.

- 1 Select the key to which you want to register a user.

- 2 Enter the user name to be displayed.

 **NOTE**

For details on entering characters, refer to the following:

➔ [Character Entry Method \(page 748\)](#)

- 3 Select [Select user].
- 4 To specify the user from local users, select [Local User]. To specify from network users, select [Network User].
The procedure differs depending on the transmission method selected.
- 5 (When specifying the user from [Local User]) Select the user to be set for simple login.

 **NOTE**

- Search by name or login user name. Select either [Search(Login)] or [Search(Name)] to switch between [Search(Login)] and [Search(Name)].
 - Select [User Name] or [Login User Name] to sort the user list.
-

- 6 (When specifying the user from [Network User]) Select the entry field for "Login User Name" and "Login Password", enter the information of the user to be registered, and select OK[OK].

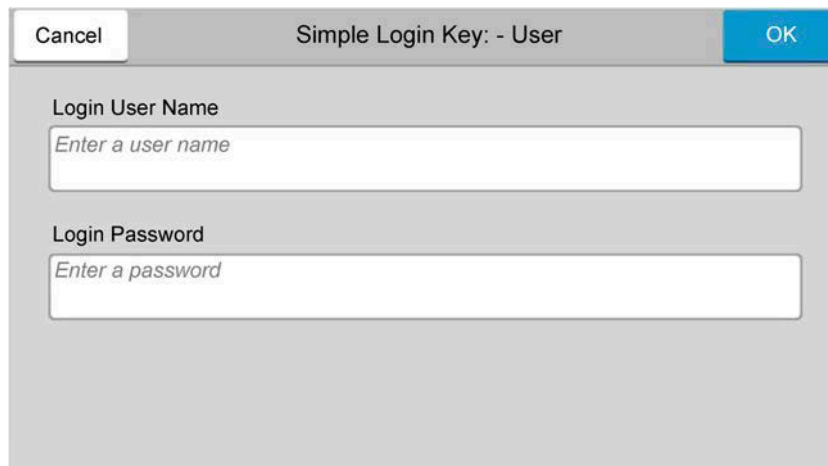

If you are specifying a user for whom a domain is set in network authentication, select the "Domain" and select the domain where the user is registered.

 **NOTE**

For details on entering characters, refer to the following:

➔ [Character Entry Method \(page 748\)](#)

- 7 Select [Password] Off or On.
- 8 Select the user icon to be displayed.

3 Register the user.

- 1 Select [Save].

ID Card Settings

If ID card authentication is enabled, select the authentication type.

NOTE

This functions appears when the Card Authentication kit is activated.

→ [Card Authentication Kit\(B\) AC <IC card authentication kit \(Activate\)> \(page 744\)](#)

Keyboard Login

When ID card authentication is enabled, select whether or not login by keyboard is allowed.

1 Display the screen.

- 1 [System Menu / Counter] key > [Job Accounting/Authentication]

NOTE

If the user authentication screen appears, log in with a user who has the privilege to configure this setting. If you do not know your login user name or password, please contact your administrator.

- 2 Select [Keyboard Login] from "ID Card Settings".

2 Configure the settings.

- 1 Select [Prohibit] or [Permit].

Additional Authentication

Select whether or not to require password entry after authenticating by ID card.

NOTE

This function is not displayed when "Server Type" from "Network Authentication" is set to [NTLM] or [Kerberos].

1 Display the screen

- 1 [System Menu / Counter] key > [Job Accounting/Authentication]

NOTE

If the user authentication screen appears, log in with a user who has the privilege to configure this setting. If you do not know your login user name or password, please contact your administrator.

- 2 Select [Additional Authentication] from "ID Card Settings".

2 Configure the settings.

- 1 Select [Off], [Use Password], or [Use PIN].



NOTE

[Use PIN] is displayed only when using PIN Code Authorization.

➔ [PIN Login \(page 549\)](#)

Simple Job Printing

Displays a list of print jobs saved to the Stored Job Box when logging in with an IC card via user login.



NOTE

For details on Simple Job Printing, refer to the following:

➔ [Simple Job Printing \(page 210\)](#)

1 Display the screen.

- 1 [System Menu / Counter] key > [Job Accounting/Authentication]



NOTE

If the user authentication screen appears, log in with a user who has the privilege to configure this setting. If you do not know your login user name or password, please contact your administrator.

- 2 Select [Quick Job Printing] from "User Login Setting".

2 Configure the settings.

Enable "Display List on Login" to configure the settings.

Logout after Printing

Select whether or not to automatically log out after printing.

Skip PIN and Copies Confirmation

Select whether or not to skip entering the PIN code and confirming the number of copies when printing when a PIN code is set.

PIN Login

NOTE

When using PIN Code Authorization, the network authentication must be enabled and [Ext.] must be selected for server type.

➔ [Enable User Login Administration \(page 521\)](#)

➔ [Server Settings \(page 535\)](#)

1 Display the screen.

- 1 [System Menu / Counter] key > [Job Accounting/Authentication]
-

NOTE

If the user authentication screen appears, log in with a user who has the privilege to configure this setting. If you do not know your login user name or password, please contact your administrator.

- 2 Select [PIN Login] from "User Login Setting".

2 Configure the function.

- 1 Select [Off] or [On]

Using User Login Administration

This section explains procedures while setting job accounting.

Login/Logout

If user login administration is enabled, the login user name and login password entry screen appears each time you use this machine. Use the procedure below to login and logout.

Login

If the login user name entry screen appears during operations, log in by referring to the following:

➔ [Login \(page 76\)](#)

Logout

When the operation is complete, select the [Logout] key. You will return to the login user name/login password entry screen.

Overview of Job Accounting

Job accounting manages the copy/print/scan/FAX count accumulated by individual accounts by assigning an ID to each account.

- 1 Enable job accounting
 - ➔ [Enabling Job Accounting \(page 552\)](#)
- 2 Setting an account.
 - ➔ [Job Accounting \(Local\) \(page 553\)](#)
- 3 Enter the assigned account ID when performing the job.
 - ➔ [Login \(page 569\)](#)
- 4 Count the number of pages printed.

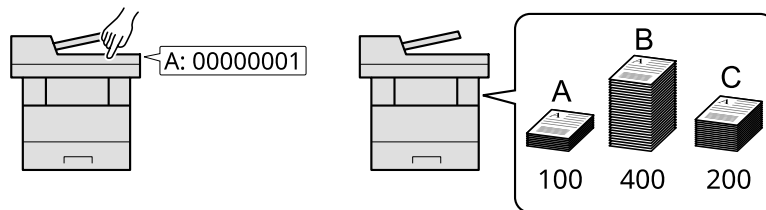

To Manage the Number of Sheets Used on Jobs Printed from a PC

To manage the number of jobs to be printed from the PC on the network, you need to configure settings by using the printer driver on the PC.

- 1 Set Job Accounting for the PC on the network by using the printer driver.
 - ➔ [Job Accounting for Printing \(page 558\)](#)
- 2 Execute printing.
- 3 Count the number of pages printed.

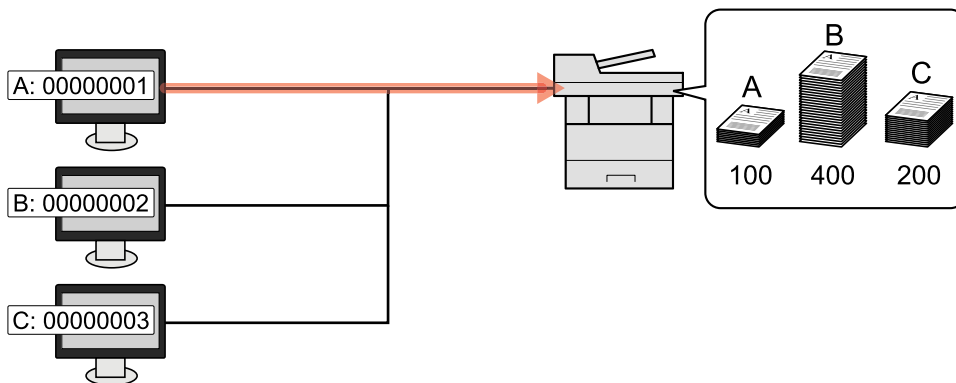

Managing the Scan Job Account by Using TWAIN

To manage the scan job account by using TWAIN, you need to configure the TWAIN driver settings on the computer connected to the machine.

- ➔ [Job Accounting for Scan Using TWAIN \(page 560\)](#)

Managing the Scan Job Account by Using WIA

To manage the scan job account by using WIA, you need to configure the WIA driver settings on the computer connected to the machine.

➔ [Job Accounting for Scan Using WIA \(page 561\)](#)

Managing the FAX Jobs Transmitted from a PC

To manage the number of FAX jobs transmitted from the PC, you need to configure the settings by using the FAX Driver on the PC.

➔ [Job Accounting for the FAX Transmitted from a Computer \(page 562\)](#)

The fax function can be used on products equipped with fax capability.

Enabling Job Accounting

1 Display the screen.

- 1 [System Menu / Counter] key > [Job Accounting/Authentication]



NOTE

If the user authentication screen appears, log in with a user who has the privilege to configure this setting. If you do not know your login user name or password, please contact your administrator.

- 2 Select "Job Accounting Setting" [Job Accounting].

2 Configure the settings.

Select [Local] or [Network].

Select [Off] to disable job accounting.



NOTE

When the display returns to System Menu default screen, logout is automatically executed and the screen to enter the Account ID appears. To continue the operation, enter the Account ID.

Job Accounting (Local)

You can add, change and delete an account and set the restriction for each account.

Adding an Account

Up to 100 individual accounts can be added.

1 Display the screen.

- 1 [System Menu / Counter] key > [Job Accounting/Authentication]



NOTE

If the user authentication screen appears, log in with a user who has the privilege to configure this setting. If you do not know your login user name or password, please contact your administrator.

- 2 Select "Job Accounting Setting" [Add/Edit Job Accounting].

2 Enter the account information.

- 1 [Add] > Add information on each item

Account Name

Enter the account name (up to 32 characters).

Account ID

Enter the account ID as many as eight digits (between 0 and 99999999).

Restriction

This prohibits printing/scanning or restricts the number of sheets to load.

➔ [Restricting the Use of the Machine \(page 554\)](#)



NOTE

- For details on entering characters, refer to the following:
➔ [Character Entry Method \(page 748\)](#)
 - Any "Account ID" that has already registered cannot be used. Enter any other account ID.
-

- 2 Select [Register].

A new account is added on the Account List.

Restricting the Use of the Machine

This section explains how to restrict the use of the machine by account or the number of sheets available.

The items that can be restricted differ depending on whether "Individual" or "Total" is selected for "Copy/Printer Count".

→ [Copier/Printer Count \(page 571\)](#)

Restriction Items

When "Copy/Printer Count" is "Individual"

Item	Description
Copy Restriction (Total)	Limits the number of sheets used for copying.
Copy Restriction (Full Color)	Limits the number of pages used for full-color copying.
Print Restriction (Total)	Limits the number of sheets used for printing. Applicable print functions are as follows: <ul style="list-style-type: none"> • Print from Box • Print from USB Drive • Print Report • Print from PC
Print Restriction (Full Color)	Limits the number of pages used for full-color printing. Applicable print functions are as follows: <ul style="list-style-type: none"> • Print from Box • Print from USB Drive • Print Report • Print from PC
Scan Restriction (Others)	Limits the number of sheets scanned (excludes copying).
Fax TX Restriction	Limits the number of sheets sent by fax. This item is displayed for fax-compatible machines.

When "Copy/Printer Count" is "Total"

Item	Description
Print Restriction (Total)	Limits the total number of sheets used for copying and printing.
Print Restriction (Full Color)	Limits the number of pages used for full-color printing and color printing.
Scan Restriction (Others)	Limits the number of sheets scanned (excludes copying).
Fax TX Restriction	Limits the number of sheets sent by fax. This item is displayed for fax-compatible machines.

Applying Restriction

Restriction can be applied in the following modes:

Item	Description
[Off]	No restriction is applied.
[Counter Limit]	Restricts the print counter in one-page increments up to 9,999,999 copies.
[Reject Usage]	Restriction is applied.

Editing an Account

1 Display the screen.

- 1 [System Menu / Counter] key > [Job Accounting/Authentication]
-



NOTE

If the user authentication screen appears, log in with a user who has the privilege to configure this setting. If you do not know your login user name or password, please contact your administrator.

- 2 Select "Job Accounting Setting" [Add/Edit Job Accounting].

2 Edit an account.

- 1 Select  (information icon) for the account name you wish to edit.
-



NOTE

- Select [Account Name] or [Account ID] to sort the account list.
-

- 2 Change the account information.

- 3 Select [Register].

The account information is changed.

Deleting an Account

1 Display the screen.

- 1 [System Menu / Counter] key > [Job Accounting/Authentication]
-



NOTE

If the user authentication screen appears, log in with a user who has the privilege to configure this setting. If you do not know your login user name or password, please contact your administrator.

- 2 Select "Job Accounting Setting" [Add/Edit Job Accounting].

2 Deleting

- 1 Select the account name you wish to delete.
-



NOTE

- Select [Account Name] or [Account ID] to sort the account list.
-

- 2 [Delete] > [Yes]

The account is deleted.

Job Accounting for Printing

To manage the number of pages used for jobs to be printed from the PC, you need to configure the following settings by using the printer driver. Instructions are based on interface elements as they appear in Windows 10.

1 Display the screen.

- 1 Select the [Start] button in Windows, select → [Windows System Tools], → [Control Panel]→ [Devices and Printers].



NOTE

- For Windows 11, select the [Start] button → [All apps]→ [Windows Tools]→ [Control Panel]→ [Devices and Printers].
- For Windows 8.1, select [Settings] in the Charms Bar on Desktop → [Control Panel]→ [Devices and Printers].

- 2 Right-click the printer driver icon of the machine, and click the [Printer properties] menu of the printer driver.
- 3 Click [Administrator] on the [Device Settings] tab.

2 Configure the settings.

- 1 Select [Job accounting] on the [Job Accounting] tab.

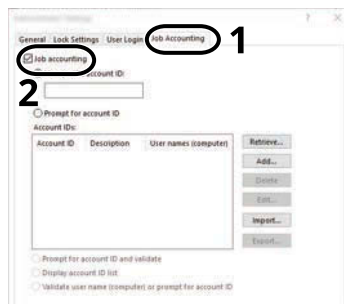

- 2 Set the Job Accounting.

[Use Specific Account ID]

Enter the Account ID. Printing will be performed using the entered Account ID. If this option is selected, the user does not have to enter the Account ID for each print job.

[Prompt for account ID]

A screen for entering the Account ID will be displayed when attempting a printing. The Account ID must be entered each time a printing is attempted.

[Prompt for account ID and validate]

A screen for entering the Account ID will be displayed when attempting a printing. The Account ID stored in the Account ID list needs to be entered. The Account ID must be entered each time a printing is attempted.

[Display account ID list]

The Account ID list is displayed when printing. The Account ID to be used needs to be selected from the list.

[Validate user name (computer) or prompt for account ID]

When printing, the Windows user name is searched in the "Account IDs" and printing is possible if the name is registered. If the Account ID is not registered, the screen for entering the Account ID will appear.

- 3 Click [OK].



NOTE

For other settings of job accounting, refer to the following:

➔ **Printer Driver User Guide**

Job Accounting for Scan Using TWAIN

To manage the number of jobs scanned by using TWAIN, you need to configure the following settings by using the TWAIN Driver on the computer. Instructions are based on interface elements as they appear in Windows 10.

1 Display the screen.

- 1 Click Search box in the taskbar, and enter "TWAIN Driver Setting". Select [TWAIN Driver Setting] in the search list. Displays the TWAIN Driver Settings screen.



NOTE

In Windows 8.1, click [Search] in charms on Desktop, and enter "TWAIN Driver Setting" in the search box. Select [TWAIN Driver Setting] in the search list.

- 2 Select the machine, and click [Edit].



2 Configure the settings.

- 1 Click [User Authentication Settings].
- 2 Select the checkbox beside [Account], and enter the account ID.



- 3 Click [OK].

Job Accounting for Scan Using WIA

To manage the number of jobs scanned by using WIA, you need to configure the following settings by using the WIA Driver on the computer. Instructions are based on interface elements as they appear in Windows 10.

1 Display the screen.

- 1 Select the Windows [Start] button → [Windows System]→ [Control Panel]. Enter "Scanner" into the search field on the control panel. Select [View scanners and cameras] in the search list then the Scanners and Cameras screen appears.



NOTE

- For Windows 11, select the [Start] button → [All apps]→ [Windows Tools]→ [Control Panel]. Enter "Scanner" into the search field on the control panel. Select [View scanners and cameras] in the search list then the Scanners and Cameras screen appears.
- In Windows 8.1, click [Search] in the Charms Bar on Desktop, and enter "View scanners and cameras" in the search box. Click [View scanners and cameras] in the search list then the Scanners and Cameras screen appears.

- 2 Select the same name as this machine from WIA Drivers, and press [Properties].

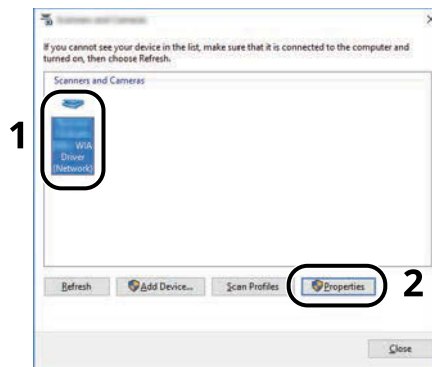

2 Configure the settings.

- 1 Select the checkbox beside [Account ID] on the [Settings] tab, and enter the Account ID.

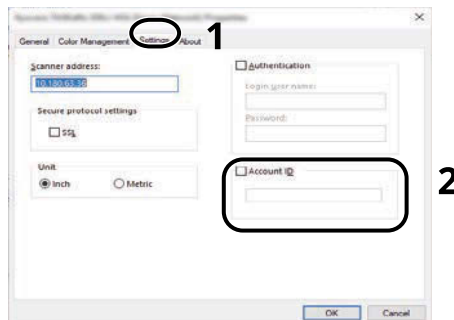

- 2 Click [OK].

Job Accounting for the FAX Transmitted from a Computer

To manage the number of FAX jobs transmitted from the computer, you need to configure the following settings by using the FAX Driver on the computer. Instructions are based on interface elements as they appear in Windows 10.

1 Display the screen.

- 1 Select the [Start] button in Windows, select → [Windows System Tools], → [Control Panel]→ [Devices and Printers].



NOTE

- For Windows 11, select the [Start] button → [All apps]→ [Windows Tools]→ [Control Panel]→ [Devices and Printers].
- For Windows 8.1, select [Settings] in the Charms Bar on Desktop → [Control Panel]→ [Devices and Printers].

- 2 Right-click the FAX driver icon of the machine, and click the [Printing preferences] menu of the printer driver.
- 3 Click [FAX TX Setting] on the [Printing Preferences] tab.

2 Configure the settings.

- 1 Select [Job Accounting] on the [Authentication] tab.

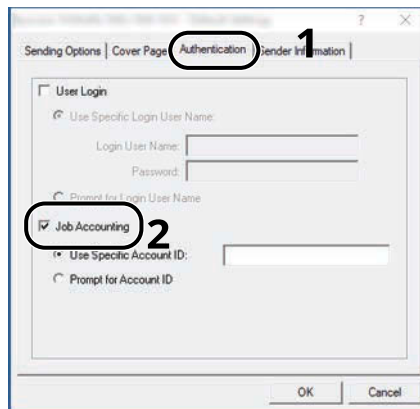

- 2 Set the Job Accounting.

[Use Specific Account ID]

This option can be used to specify an account ID to use the same Account ID for every FAX job. If this option is selected, the user does not have to enter the Account ID for each FAX job.

[Prompt for Account ID]

A screen for entering the Account ID will be displayed when attempting a transmission. The Account ID must be entered each time a transmission is attempted.

- 3 Click [OK].

Configuring Job Accounting

Default Counter Limit

When you add a new account, you can change the default restrictions on the number of sheets used. You can set any number from 1 to 9,999,999.

The items that can be set differ depending on whether [Individual] or [Total] is selected for [Copy/Printer Count].

→ [Copier/Printer Count \(page 571\)](#)

1 Display the screen.

- 1 [System Menu / Counter] key > [Job Accounting/Authentication]



NOTE

If the user authentication screen appears, log in with a user who has the privilege to configure this setting. If you do not know your login user name or password, please contact your administrator.

- 2 Select "Job Accounting Setting" [Job Accounting Setting].

2 Configure the settings.

- 1 Select the item for "Default Counter Limit" > use [+], [-] or the numeric keys to enter the default restriction on the number of sheets > [OK]

When [Copy/Printer Count] is set to [Individual]

[Copy Restriction (Total)]

Sets the default restriction on the number of sheets used for copying.

[Copy Restriction (Full Color)]

Sets the default restriction on the number of sheets used for full-color copying.

[Print Restriction (Total)]

Sets the default restriction on the number of sheets used for printing.

Applicable print functions are as follows:

- Print from Box
- Print from USB Drive
- Print Report
- Print from PC

[Print Restriction (Full Color)]

Sets the default restriction on the number of sheets used for full-color printing.

Applicable print functions are as follows:

- Print from Box
- Print from USB Drive
- Print Report
- Print from PC

[Scan Restriction (Others)]

Sets the default restriction on the number of sheets used for scanning (excludes copying).

[Fax TX Restriction]

Sets the default restriction on the number of sheets used for sending faxes.

This item is displayed for fax-compatible machines.

When [Copy/Printer Count] is set to [Total]

[Print Restriction (Total)]

Sets the default restriction on the total number of sheets used for copying and printing.

[Print Restriction (Full Color)]

Sets the default restriction on the number of sheets used for full-color printing.

[Scan Restriction (Others)]

Sets the default restriction on the number of sheets used for scanning (excludes copying).

[Fax TX Restriction]

Sets the default restriction on the number of sheets used for sending faxes.

This item is displayed for fax-compatible machines.

Counting the Number of Pages Printed

This counts the number of pages printed. Counts are classified into Total Job Accounting and Each Job Accounting. A new count can also be started after resetting the count data which was stored for a certain period of time.

The items that can be referenced are as follows:

Item	Description
[Printed Pages]	<p>Displays the number of pages used in printing for each of the following item.</p> <p>Count by Function Displays the number of pages used to copy, print, FAX and their total, for each color mode.</p> <p>Count by Duplex Displays the number of pages used in Duplex (1-sided) mode, Duplex (2-sided) mode and the total for both.</p> <p>Count by Combine Displays the number of pages used in Combine (None) mode, Combine (2 in 1) mode, Combine (4 in 1) mode and the total for all three.</p>
[Scanned Pages]	Displays the number of pages scanned for copying, faxing, printing and other functions, as well as the total number of pages scanned.
Fax Transmission Pages	Displays the number of pages faxed.
Fax Transmission Time	Displays the total duration of FAX transmissions.

Item	Description
[Counter Reset]	Resets the counter. Select [Reset] on the confirmation screen.

Counting the Number of Pages for All Accounts

This counts the number of pages for each account. In addition, you can reset the counts for all accounts at the same time.

1 Display the screen.

- 1 [System Menu / Counter] key > [Job Accounting/Authentication]



NOTE

If the user authentication screen appears, log in with a user who has the privilege to configure this setting. If you do not know your login user name or password, please contact your administrator.

- 2 Select "Job Accounting Setting" [Job Accounting Counter].

2 Check the number of pages.

- 1 Select [Total] to check the count.
Select [Counter Reset] to reset the counter.
- 2 Confirm the count and select [Close].

Counting the Number of Pages for Each Account

This counts the number of pages for each account and resets the counts by account. When checking Each Job Accounting, select the account for which you want to check the count.

1 Display the screen.

- 1 [System Menu / Counter] key > [Job Accounting/Authentication]



NOTE

If the user authentication screen appears, log in with a user who has the privilege to configure this setting. If you do not know your login user name or password, please contact your administrator.

- 2 Select "Job Accounting Setting" [Job Accounting Counter].

2 Check the number of pages.

- 1 Select the account.



NOTE

- Select [Account Name] or [Account ID] to sort the account list.
 - To display an account other than your own account, select [Other Account].
-

- 2 Check the count.
Select [Counter Reset] to reset the counter.
- 3 Confirm the count and select [Close].

Print Accounting Report

The total pages counted of all relevant accounts can be printed as an accounting report.

1 Prepare paper.

Check that A4 or Letter paper is loaded in the cassette.

2 Display the screen.

1 [System Menu / Counter] key > [Job Accounting/Authentication]



NOTE

If the user authentication screen appears, log in with a user who has the privilege to configure this setting. If you do not know your login user name or password, please contact your administrator.

3 Print.

1 "Job Accounting Setting" [Print Accounting Report] > [Print]

Accounting report is printed.

Reports have different formats depending on how the count of copiers and printers is administered. If count by paper size is being performed, then the report will be printed per size.

Using Job Accounting

This section explains procedures while setting job accounting.

Login

If job accounting is enabled, an account ID entry screen appears each time you use this machine.

1 Enter the account ID using the numeric keys > [Login]

 **NOTE**

- If you entered a wrong character, select [C] (Clear) and enter the account ID again.
 - If the entered account ID does not match the registered ID, a warning beep will sound and login will fail. Enter the correct account ID.
 - By selecting [Check Counter], you can refer to the number of pages printed and the number of pages scanned.
-

If user login administration is enabled, the screen to enter the login user name and password appears instead of the screen to enter the account ID. Enter a login user name and password to login. If the user has already registered the account information, the account ID entry would be skipped.

→ [Adding a User \(Local User List\) \(page 524\)](#)

2 Proceed to complete the rest of the steps.

Logout

- 1 When the operation is complete, select the [Logout]key. Return to the Enter Account ID screen.

Apply Limit

This specifies how the machine behaves when the counter has reached the limit of restriction. The action is as follows:

Item	Description
[Immediately]	Job stops when the counter reaches its limit. If sending or storing in the box is already underway, prohibition will become effective from the next job.
[Subsequently]	The print or scan job currently underway will continue but the subsequent job will be rejected.
[Alert Only]	Job continues while displaying an alert message.

1 Display the screen.

- 1 [System Menu / Counter] key > [Job Accounting/Authentication]



NOTE

If the user authentication screen appears, log in with a user who has the privilege to configure this setting. If you do not know your login user name or password, please contact your administrator.

- 2 "Job Accounting Setting" [Job Accounting Setting] > "Default Setting" [Apply Limit]

2 Configure the function.

- 1 Select [Immediately], [Subsequently], or [Alert Only].

Copier/Printer Count

You can select how the copying and printing page counts are shown - either the total of both or each of copying and printing individually. The selection may influence restriction on the count and count method. For details, refer to the following:

- ➔ [Restricting the Use of the Machine \(page 554\)](#)
- ➔ [Counting the Number of Pages Printed \(page 564\)](#)
- ➔ [Print Accounting Report \(page 568\)](#)

1 Display the screen.

- 1 [System Menu / Counter] key > [Job Accounting/Authentication]



NOTE

If the user authentication screen appears, log in with a user who has the privilege to configure this setting. If you do not know your login user name or password, please contact your administrator.

- 2 "Job Accounting Setting" [Job Accounting Setting] > "Default Setting" [Copy/Printer Count]

2 Configure the function.

- 1 Select [Total] or [Individual].

Unknown User Settings

Unknown ID Job

This specifies the behavior for handling the jobs sent with unknown or unsent login user names or User ID. If the User Login is set to invalid and Job Accounting is set to valid, follow the procedure when the Account ID is unknown.

1 Display the screen.

- 1 [System Menu / Counter] key > [Job Accounting/Authentication]



NOTE

If the user authentication screen appears, log in with a user who has the privilege to configure this setting. If you do not know your login user name or password, please contact your administrator.

- 2 Select "Unknown User Settings" [Unknown ID Job].

2 Configure the settings.

Select [Reject] or [Permit].

[Permit]

The job is permitted to be printed.

[Reject]

The job is rejected (not printed).

Registering Information for a User whose ID is Unknown

If you register user information for a user whose ID is unknown, you can check information on the Job Status or Job History screens. In addition, you can restrict available functions.



NOTE

This function is displayed when [Unknown ID Job] is set to [Permit].

➔ [Unknown ID Job \(page 572\)](#)

1 Display the screen.

- 1 [System Menu / Counter] key > [Job Accounting/Authentication]



NOTE

If the user authentication screen appears, log in with a user who has the privilege to configure this setting. If you do not know your login user name or password, please contact your administrator.

- 2 Select "Unknown User Settings" [User Property].

2 Enter the user information.

- 1 Add information on each item > [Save]

User Name

Enter the name displayed on the user list (up to 32 characters).

[Account Name]

Register an account for a user whose ID is unknown.

➔ [Overview of Job Accounting \(page 550\)](#)



NOTE

- Select [Account Name] or [Account ID] to sort the account list.
-

Authorization Rules

Set usage authority.

The following restriction items are available:

Print Restriction

Select whether or not use of the print function of the printer is prohibited.

Applicable print functions are as follows:

- Print from PC

Print Restriction (Color)

Select whether or not use of the print function (color) of the printer is prohibited.

Applicable print functions are as follows:

- Print from PC

10 Troubleshooting

Regular Maintenance

Cleaning

Clean the machine regularly to ensure optimum printing quality.

CAUTION

For safety, always unplug the power cord before cleaning the machine.

Cleaning Platen

Wipe the inside of the document processor and the platen with a soft cloth dampened with alcohol or mild detergent.

IMPORTANT

Do not use thinner or other organic solvents.

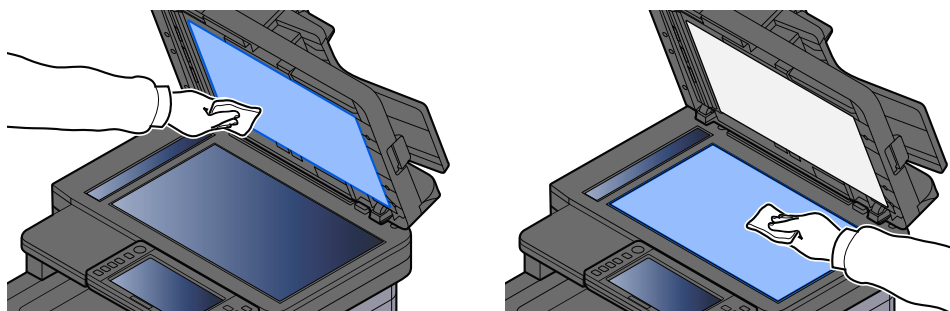

Cleaning Slit Glass

When using the document processor, clean the slit glass surface and the reading guide with the dry cloth.

 **IMPORTANT**

Do not use water, soap or solvents for cleaning.

 **NOTE**

Dirt on the slit glass or the reading guide may cause black streaks to appear in the output.

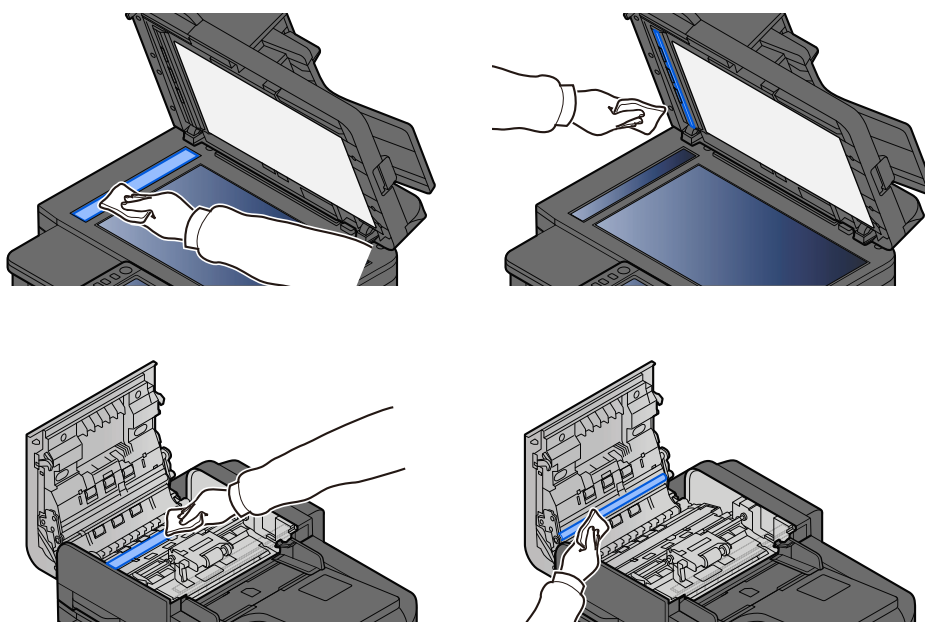

Cleaning Paper Transfer Unit

The paper transfer unit should be cleaned each time the toner container and waste toner box are replaced. To maintain optimum print quality, it is also recommended that the inside of the machine be cleaned once a month as well as when the toner container is replaced.

Print problems such as soiling of the reverse side of printed pages may occur if the paper transfer unit becomes dirty.

CAUTION

Some parts are very hot inside the machine. Exercise caution as there is a risk of burn injury.

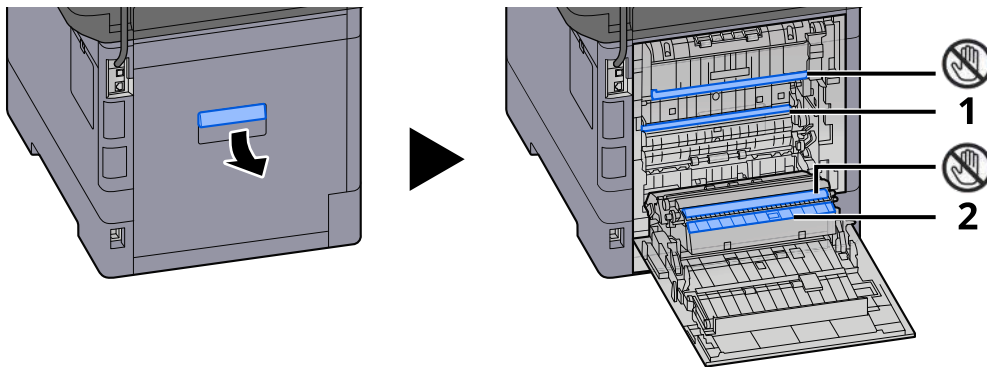

Wipe away the paper dust on paper 1 and dirt on paper 2 using a soft, dry cloth.

IMPORTANT

Be careful not to touch the  part during cleaning. It may deteriorate the print quality.

Replacing the Toner Container

When toner is empty, the following message will be displayed. Replace the toner container.

"Toner[C][M][Y][K]is empty."

When toner runs low, the following message will be displayed. Make sure you have a new toner container available for replacement.

"Toner [C][M][Y][K] is low. (Replace when empty.)"

NOTE

- For the toner container, always use a genuine toner container. Using a toner container that is not genuine may cause image defects and product failure.
- The memory chip in the toner container of this product stores information necessary for improving customer convenience, operation of the recycling system for used toner containers, and planning and development of new products. The stored information does not include information that makes it possible to identify individuals, and is only used anonymously for the above purposes.

CAUTION

Do not attempt to incinerate parts which contain toner. Dangerous sparks may cause burns.

Installation procedures of the toner container is same for every color. Here, we'll explain the procedures for the yellow toner container, as an example.

1 Open the Scanner Unit

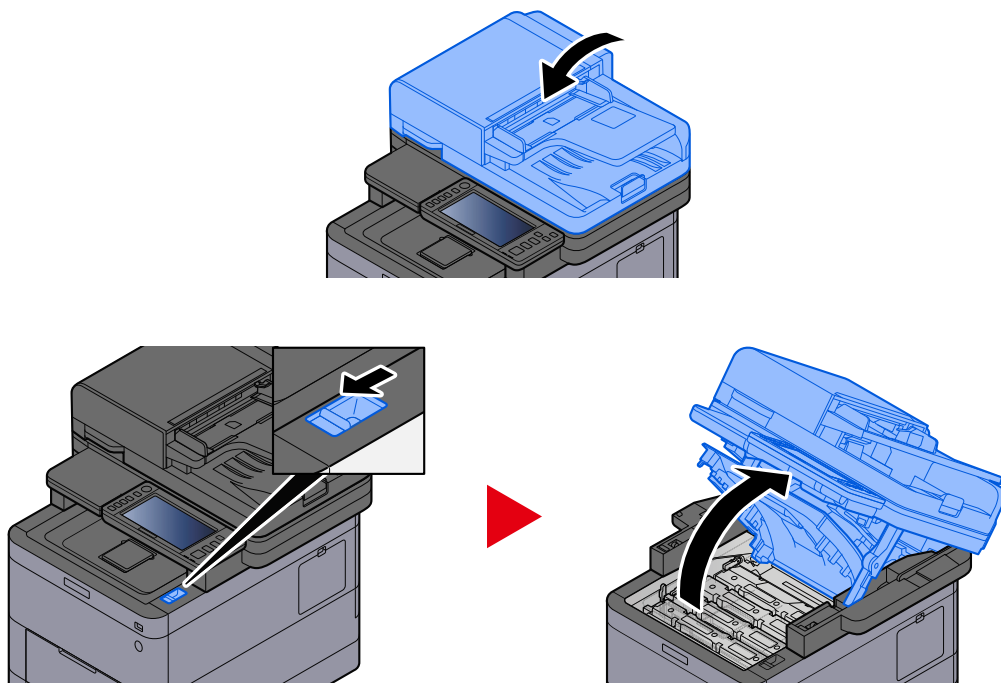

The Toner Container Lock of the empty toner container is unlocked.

 **NOTE**

If the toner container is locked, select [Unlock toner container] and release the toner container lock.

2 Remove the toner container.

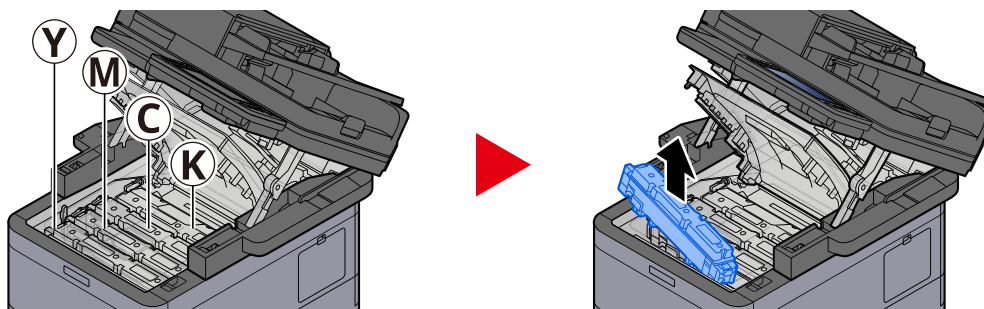

3 Put used toner container into the plastic waste bag.

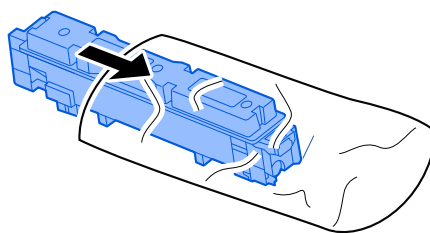

4 Remove the new toner container from the box.

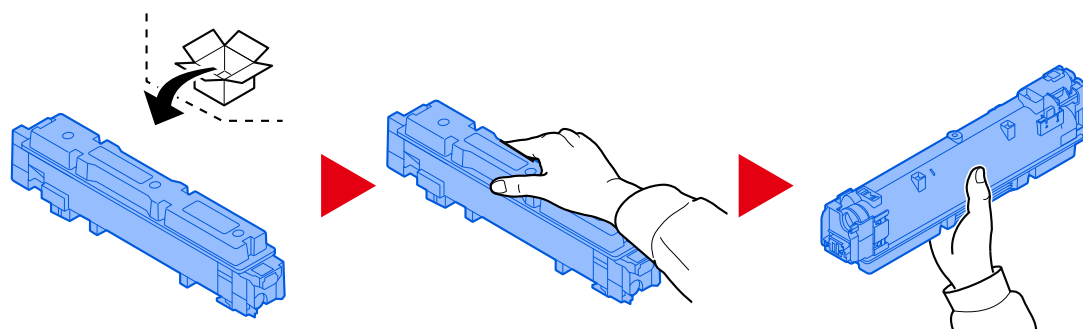

✔ **IMPORTANT**

Do not touch the points shown below.

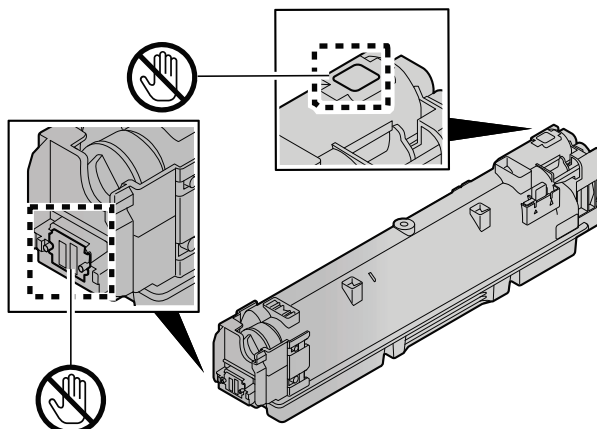

5 Shake the toner container.

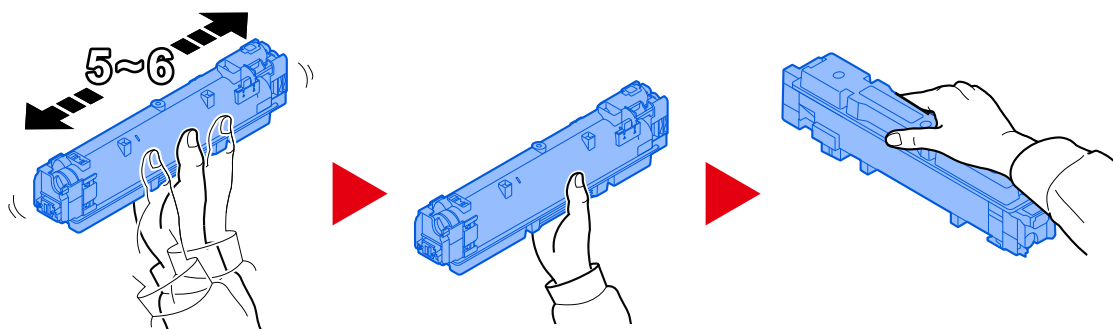

6 Install the toner container.

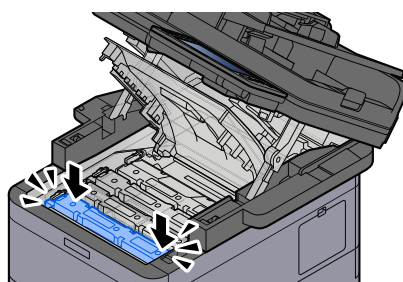

✔ **IMPORTANT**

Insert the toner container all the way.

7 Close the Scanner Unit

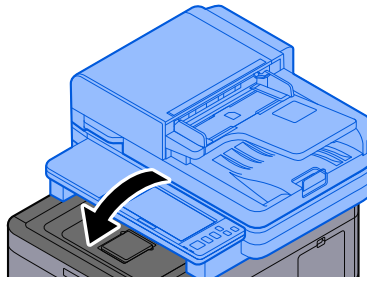

NOTE

- If the Scanner Unit does not close, check that the new toner container is installed correctly.
 - Return the exhausted toner container to your dealer or service representative. The collected toner container will be recycled or disposed in accordance with the relevant regulations.
-

Replacing the Waste Toner Box

When the waste toner box is full, the following message will be displayed.

"Waste Toner Box is full."



CAUTION

Do not attempt to incinerate parts which contain toner. Dangerous sparks may cause burns.

1 Open the Waste Toner Cover

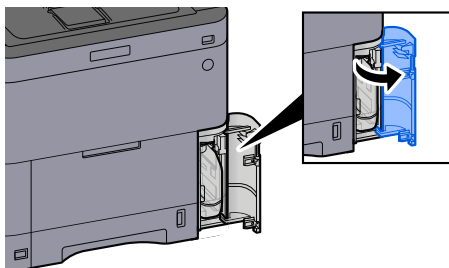

2 Remove the Waste Toner Box.

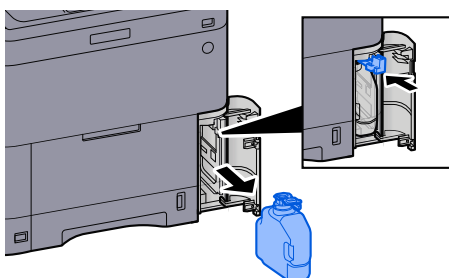

3 Put used Waste Toner Box into the plastic waste bag.

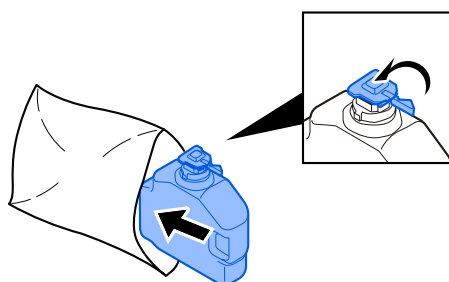

4 Remove the new Waste Toner Box.

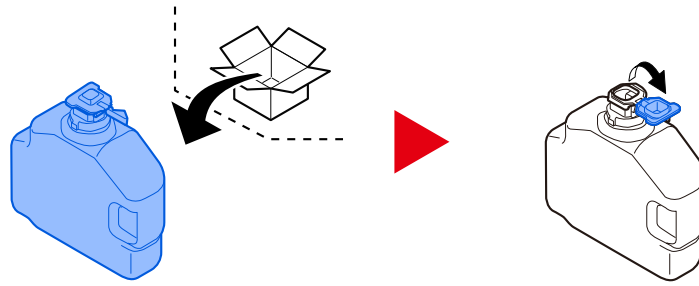

5 Install the Waste Toner Box.

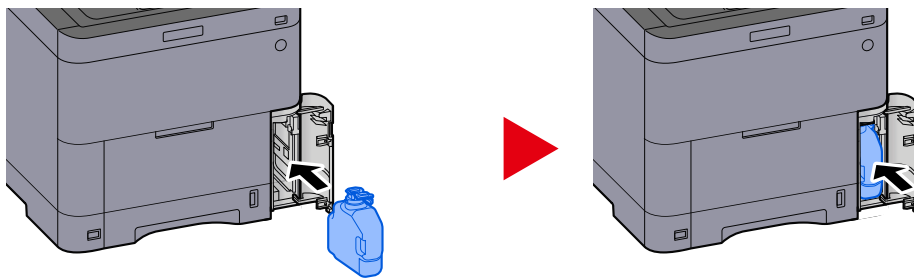

6 Close the Waste Toner Cover

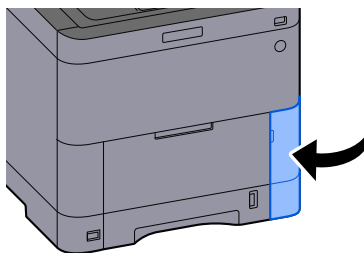

 **NOTE**

Return the exhausted waste toner box to your dealer or service representative. The collected waste toner box will be recycled or disposed in accordance with the relevant regulations.

Troubleshooting

Solving Malfunctions

If a problem occurs with your machine, look into the checkpoints and perform procedures indicated on the following pages. The table below provides general guidelines for problem solving. If the problem persists, contact your service representative.



NOTE

When contacting us, the serial number will be necessary. To check the serial number, refer to the following:

→ [Checking the Equipment's Serial Number \(page 2\)](#)

Machine Operation Trouble

The application does not start up

Is the auto panel reset setting time set too short?

Check the set time for auto panel reset.

- 1 [System Menu / Counter] key > [DeviceSettings] > [Energy Saver/Timer] > [Panel Reset Timer]**
- 2 Set the panel reset time to 30 seconds or more**
It can be set in the range of 5 to 495 seconds (in 5 second increments).

The screen does not respond when the power switch is turned on

Is the machine plugged in?

1 Plug in the power cord that comes with this machine to an outlet.

Make sure the power plug is securely plugged in.

Machine does not print even when [Start] is pressed

Is there a message displayed on the screen?

If a message is displayed on the screen, you may not be able to operate it depending on what is displayed. Determine the appropriate response to the message and respond accordingly.

Is the machine in Sleep mode?

Operation can't be done when it is in sleep mode.

1 Press any key on the control panel



NOTE

It's possible to return from sleep mode by the following method:

- Touch the touch panel
 - Loading Originals in the document processor
 - Open the document processor
-

Blank sheets are ejected

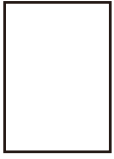

Are the originals loaded correctly?

Placing Originals on the Platen

1 Put the scanning side facedown.

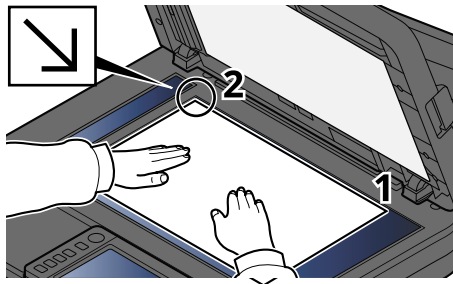

2 Align it flush against the original size indicator plates with the back left corner as the reference point.



NOTE

For details on Original Orientation, refer to the following:

→ [Original Size \(page 321\)](#)

Placing Originals in the Document Processor

1 Adjust the original width guides.

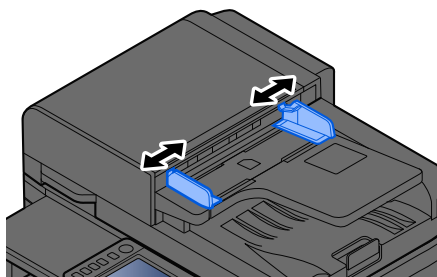

2 Place the original.

- 1 Put the side to be scanned (or the first side of two-sided originals) face-up. Slide the leading edge into the document processor as far as it will go.

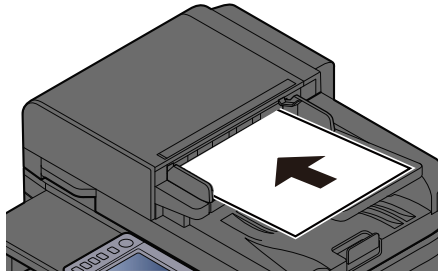

NOTE

For details on Original Orientation, refer to the following:

→ [Original Orientation \(page 328\)](#)



IMPORTANT

Confirm that the original width guides exactly fit the originals. If there is a gap, readjust the original width guides. The gap may cause the originals to jam.

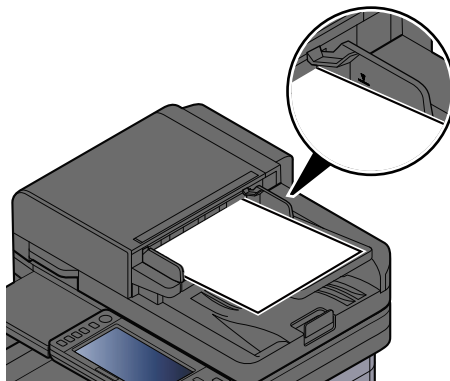

Ensure that loaded originals do not exceed the level indicator. Exceeding the maximum level may cause the originals to jam.

Originals with punched holes or perforated lines should be placed with the punched holes or perforated lines on the right side (so that they will be scanned last).

- 2 Open the original stopper to fit the size of the original set.

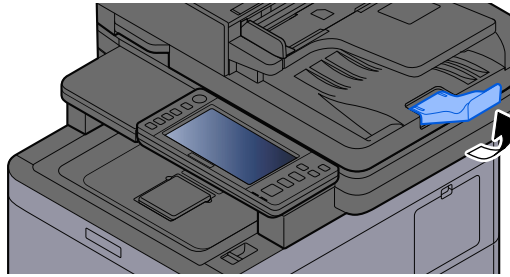

Is the application software set correctly?

Check the settings of the application software.

Paper often jams

Is the paper loaded correctly?

Load the paper correctly.

When loading paper in a cassette

1 Pull the cassette completely out of the machine.

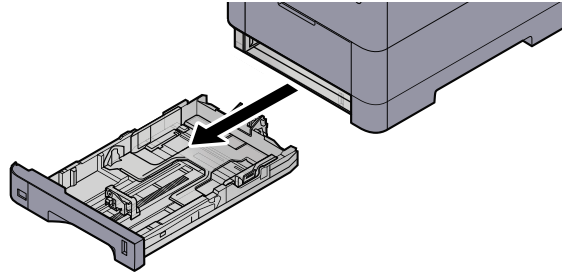

NOTE

When pulling the cassette out of the machine, ensure it is supported and does not fall out.

2 Adjust the cassette size.

- 1 Adjust the position of the paper width guides located on the left and right sides of the cassette. Press the paper width adjusting tab and slide the guides to the paper size required.

Paper sizes are marked on the cassette.

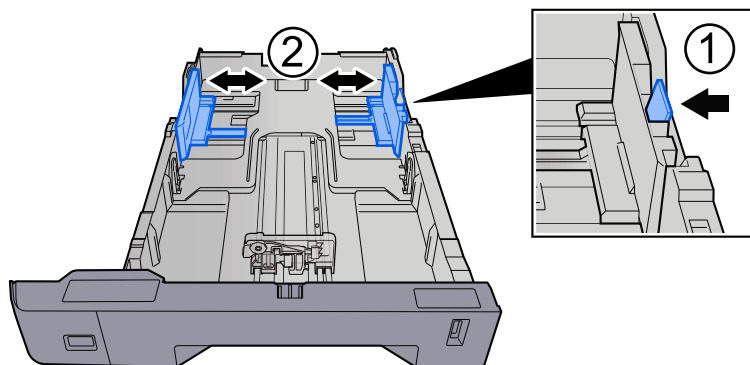

- 2 Adjust the paper length guide to the paper size required. Press the paper length adjusting tab and slide the guides to the paper size required.

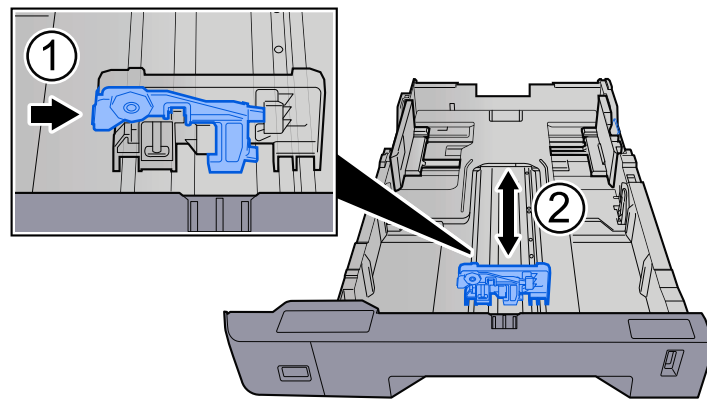

- 3 Turn the size dial so that the size of the paper you are going to use appears in the paper size window.

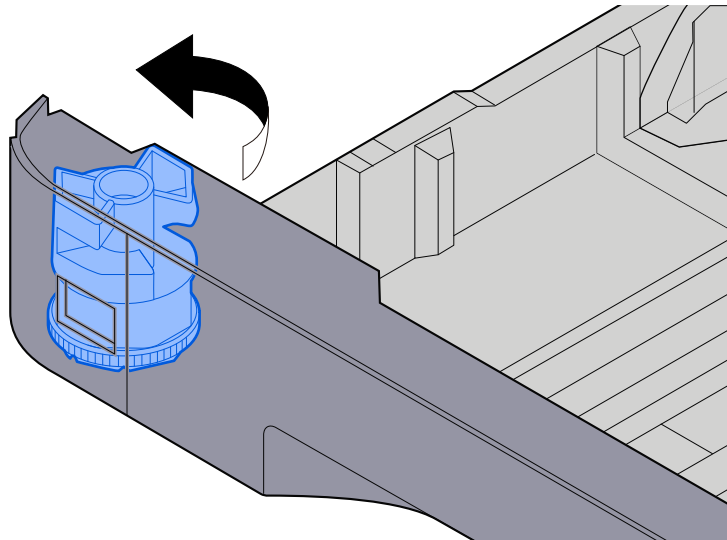

NOTE

Set the size dial to Other if you wish to use paper that is other than the Standard Size. In this case, it is necessary to set the paper size from the operation panel.

➔ [Specifying Paper Size and Media Type \(page 152\)](#)

3 Load paper.

- 1 Fan the paper, then tap it on a level surface to avoid paper jams or skewed printing.

2 Load the paper in the cassette.

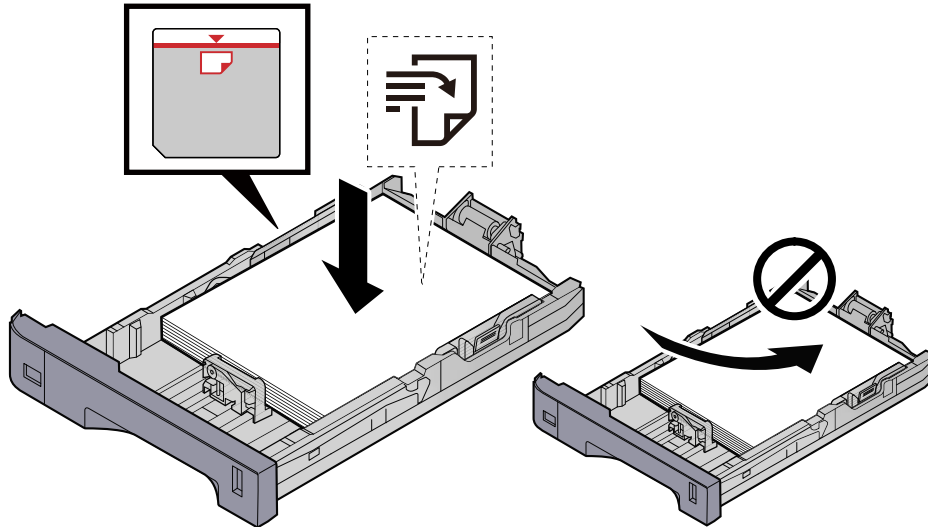

✔ **IMPORTANT**

- Load the paper with the print side facing up.
- After removing new paper from its packaging, fan out the paper before loading it in the cassettes.
➔ [Precaution for Loading Paper \(page 144\)](#)
- Before loading the paper, be sure that it is not curled or folded. Paper that is curled or folded may cause paper jams.
- Ensure that the loaded paper does not exceed the level indicator (see illustration above).
- If paper is loaded without adjusting the paper length guide and paper width guide, the paper may skew or become jammed.

4 Gently push the cassette back in.

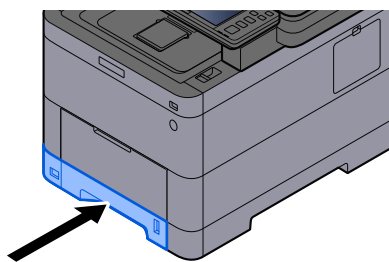



NOTE

There is a paper gauge on the right side of the front of the cassette. The display changes up and down to match the remaining amount of paper.

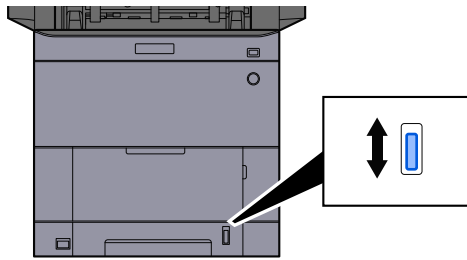

5 Specify the type of paper loaded in the cassette using the operation panel.

→ [Specifying Paper Size and Media Type \(page 152\)](#)

When loading paper in the multipurpose tray

1 Open the multipurpose tray.

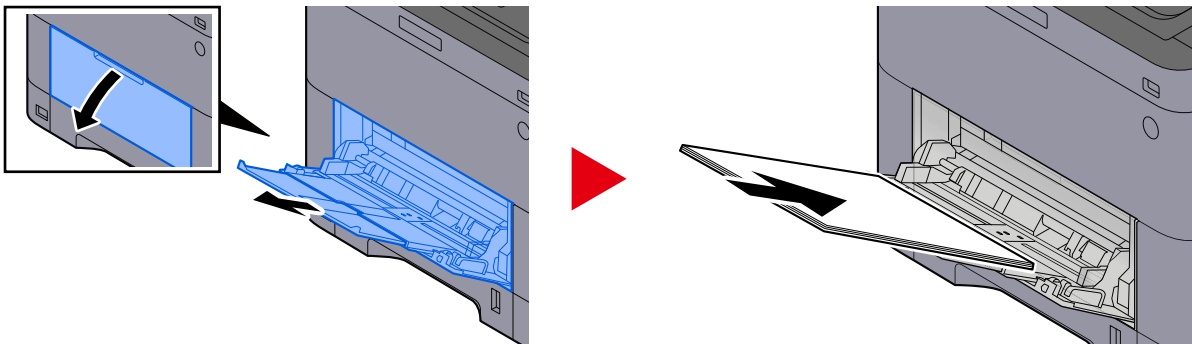

2 Adjust the multipurpose tray size.

Paper sizes are marked on the multipurpose tray.

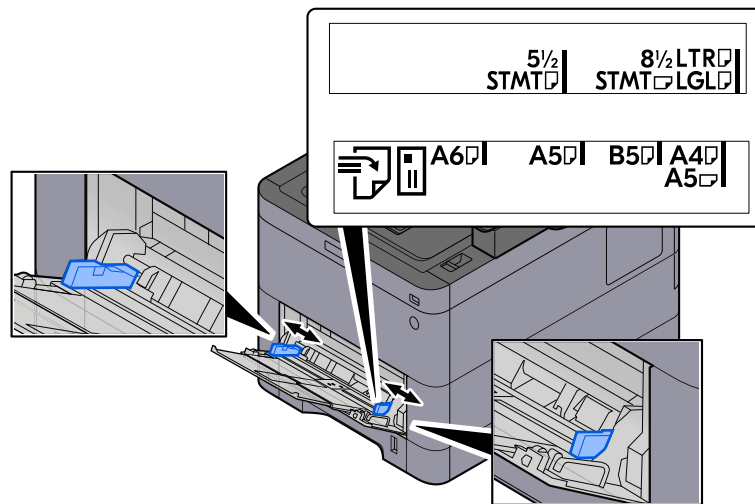

3 Load paper.

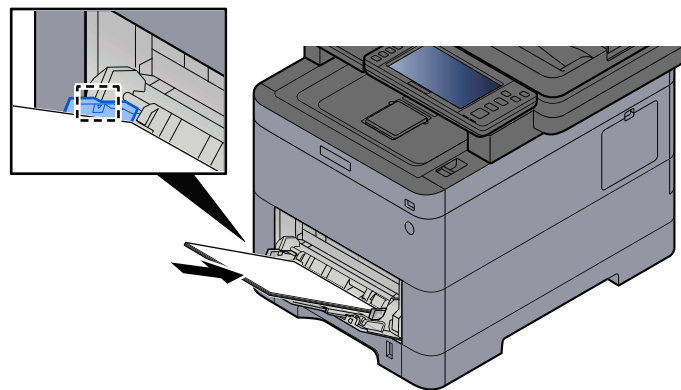

Insert the paper along the paper width guides into the tray until it stops.

After removing new paper from its packaging, fan the paper before loading it in the multipurpose tray.

➔ [Precaution for Loading Paper \(page 144\)](#)

✔ IMPORTANT

- When loading the paper, keep the print side facing up.
- Curled paper must be uncurled before use.
- When loading paper into the multipurpose tray, check that there is no paper left over in the tray from a previous job before loading the paper. If there is just a small amount of paper left over in the multipurpose tray and you want to add more, first remove the left-over paper from the tray and include it with the new paper before loading the paper back into the tray.
- If there is a gap between the paper and the paper width guides, readjust the guides to fit the paper in order to prevent skewed feeding and paper jams.
- Ensure that the loaded paper does not exceed the load limits.

When you load envelopes or cardstock in the multipurpose tray, load the paper with the print side facing up. For the procedure for printing, refer to the Printer Driver User Guide.

➔ [Printer Driver User Guide](#)

Example: When printing the address.

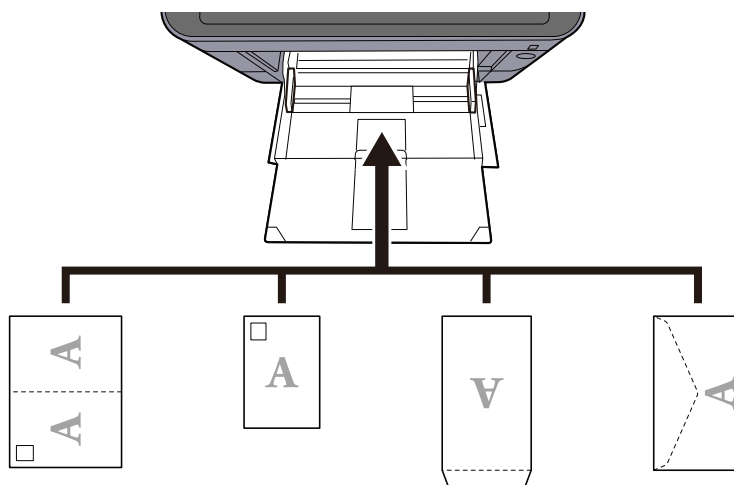

IMPORTANT

- Use unfolded Oufuku hagaki (Return postcard).
- How to load envelopes (orientation and facing) will differ depending on the type of envelope. Be sure to load it in correctly, otherwise printing may be done in the wrong direction or on the wrong face.

NOTE

When you load envelopes in the multipurpose tray, select the envelope type by referring to the following:

➔ [\[MP Tray Settings\] \(page 431\)](#)

4 Specify the type of paper loaded in the multipurpose tray using the operation panel.

➔ [Specifying Paper Size and Media Type \(page 152\)](#)

Remove the paper from the multipurpose tray once and change the loading direction by rotating the paper 180 degrees.

➔ [Precaution for Loading Paper \(page 144\)](#)

Is the paper of the supported type? Is it in good condition?

Remove the paper from the cassette, turn it over, and then reload it.

➔ [Precaution for Loading Paper \(page 144\)](#)

Is the paper curled, folded or wrinkled?

Replace the paper with new paper.

➔ [Precaution for Loading Paper \(page 144\)](#)

Are there any loose scraps or jammed paper in the machine?

Remove the jammed paper.

➔ [Clearing Paper Jams \(page 725\)](#)

Two or more sheets are overlaps when ejected (multi feeding)

ABC
123

Is the paper loaded correctly?

Load the paper correctly.

When loading paper in a cassette

1 Pull the cassette completely out of the machine.

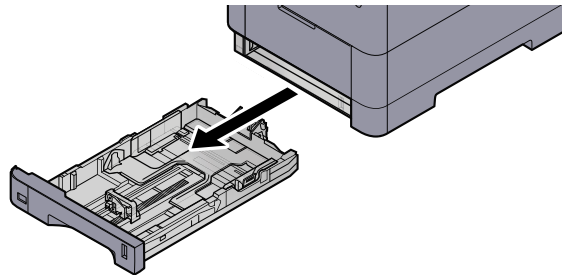

NOTE

When pulling the cassette out of the machine, ensure it is supported and does not fall out.

2 Adjust the cassette size.

- 1 Adjust the position of the paper width guides located on the left and right sides of the cassette. Press the paper width adjusting tab and slide the guides to the paper size required.

Paper sizes are marked on the cassette.

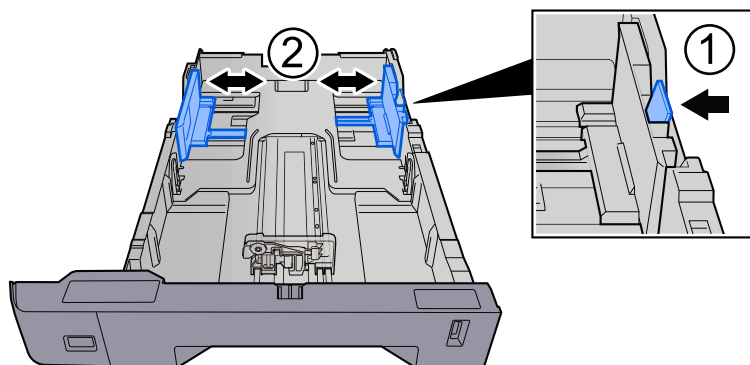

- 2 Adjust the paper length guide to the paper size required. Press the paper length adjusting tab and slide the guides to the paper size required.

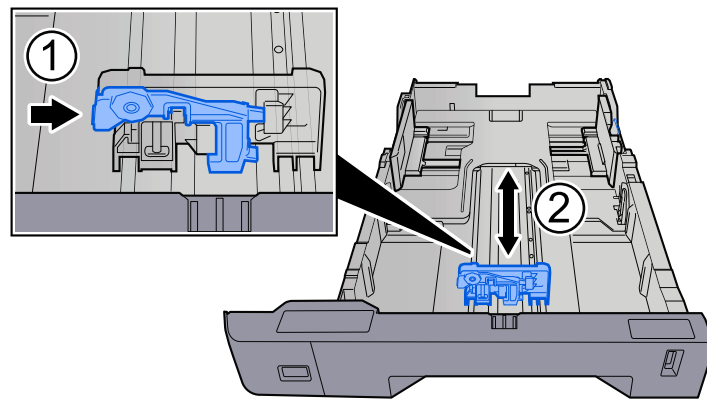

- 3 Turn the size dial so that the size of the paper you are going to use appears in the paper size window.

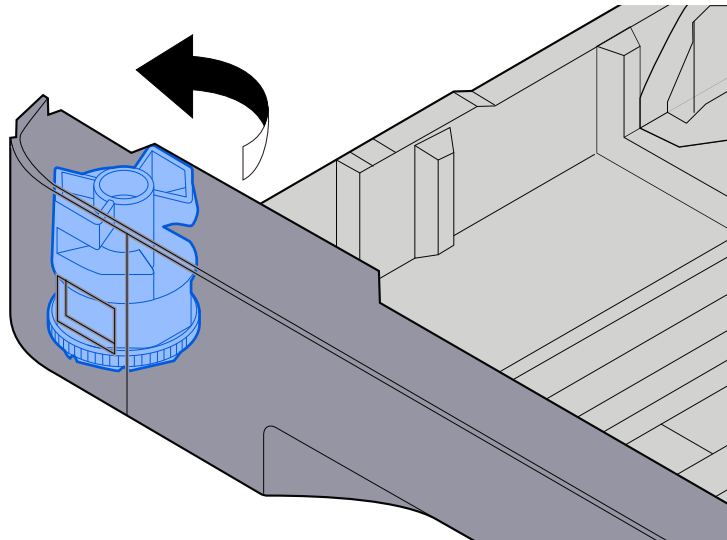

NOTE

Set the size dial to Other if you wish to use paper that is other than the Standard Size. In this case, it is necessary to set the paper size from the operation panel.

➔ [Specifying Paper Size and Media Type \(page 152\)](#)

3 Load paper.

- 1 Fan the paper, then tap it on a level surface to avoid paper jams or skewed printing.

2 Load the paper in the cassette.

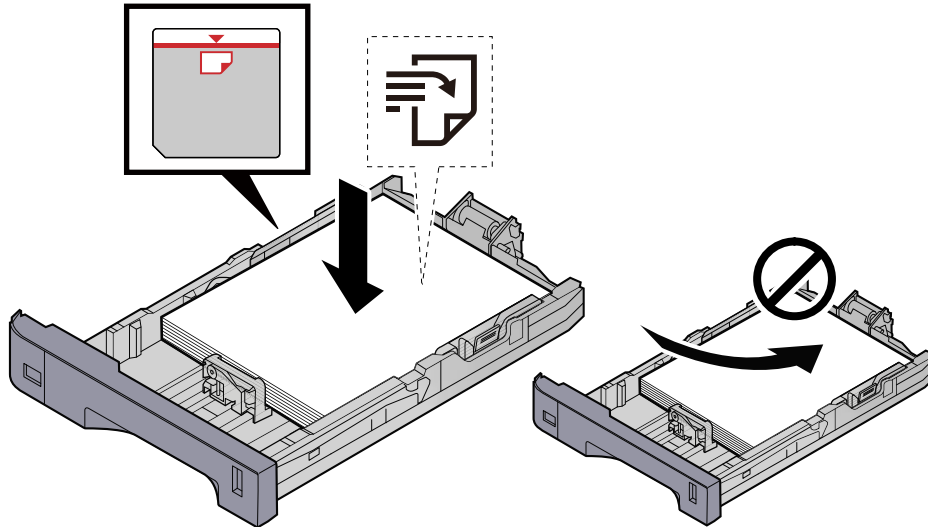

✓ **IMPORTANT**

- Load the paper with the print side facing up.
- After removing new paper from its packaging, fan out the paper before loading it in the cassettes.
➔ [Precaution for Loading Paper \(page 144\)](#)
- Before loading the paper, be sure that it is not curled or folded. Paper that is curled or folded may cause paper jams.
- Ensure that the loaded paper does not exceed the level indicator (see illustration above).
- If paper is loaded without adjusting the paper length guide and paper width guide, the paper may skew or become jammed.

4 Gently push the cassette back in.

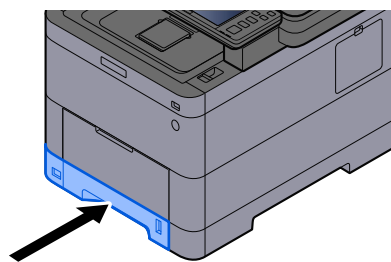



NOTE

There is a paper gauge on the right side of the front of the cassette. The display changes up and down to match the remaining amount of paper.

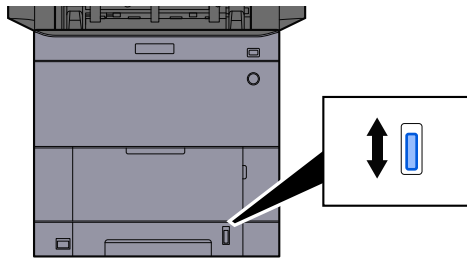

5 Specify the type of paper loaded in the cassette using the operation panel.

→ [Specifying Paper Size and Media Type \(page 152\)](#)

When loading paper in the multipurpose tray

1 Open the multipurpose tray.

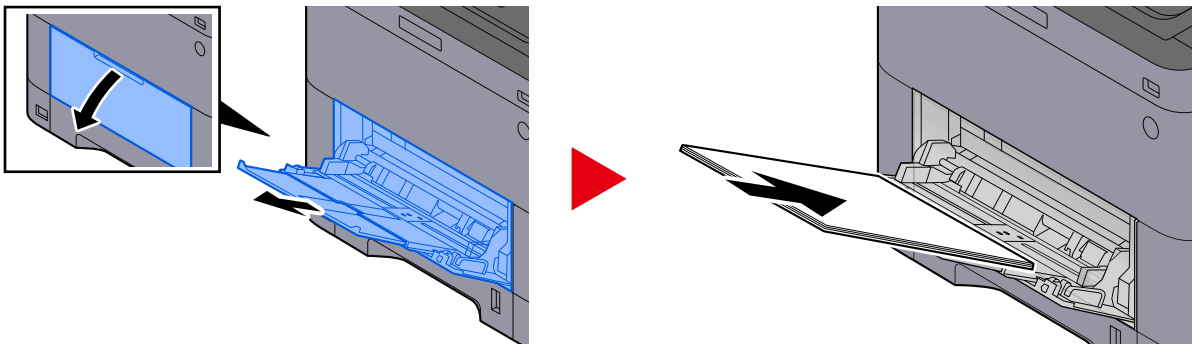

2 Adjust the multipurpose tray size.

Paper sizes are marked on the multipurpose tray.

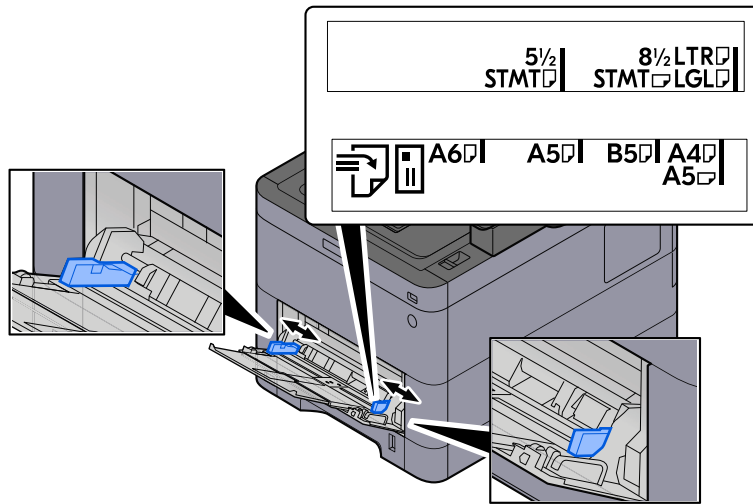

3 Load paper.

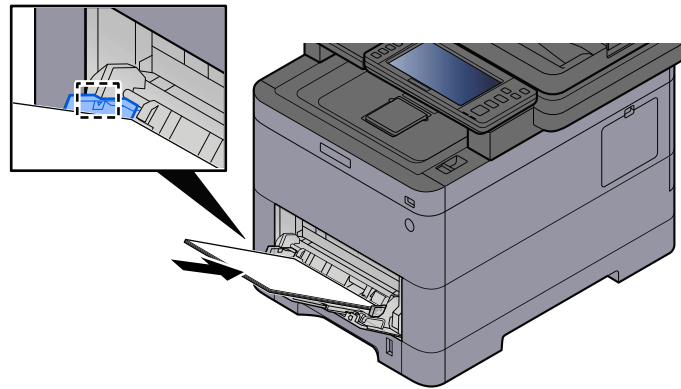

Insert the paper along the paper width guides into the tray until it stops.

After removing new paper from its packaging, fan the paper before loading it in the multipurpose tray.

➔ [Precaution for Loading Paper \(page 144\)](#)

✔ IMPORTANT

- When loading the paper, keep the print side facing up.
- Curled paper must be uncurled before use.
- When loading paper into the multipurpose tray, check that there is no paper left over in the tray from a previous job before loading the paper. If there is just a small amount of paper left over in the multipurpose tray and you want to add more, first remove the left-over paper from the tray and include it with the new paper before loading the paper back into the tray.
- If there is a gap between the paper and the paper width guides, readjust the guides to fit the paper in order to prevent skewed feeding and paper jams.
- Ensure that the loaded paper does not exceed the load limits.

When you load envelopes or cardstock in the multipurpose tray, load the paper with the print side facing up. For the procedure for printing, refer to the Printer Driver User Guide.

➔ [Printer Driver User Guide](#)

Example: When printing the address.

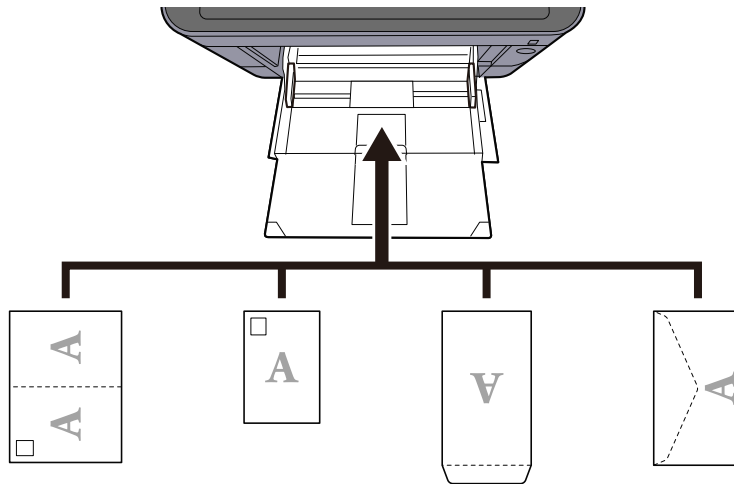

✓ IMPORTANT

- Use unfolded Oufuku hagaki (Return postcard).
- How to load envelopes (orientation and facing) will differ depending on the type of envelope. Be sure to load it in correctly, otherwise printing may be done in the wrong direction or on the wrong face.

📌 NOTE

When you load envelopes in the multipurpose tray, select the envelope type by referring to the following:

➔ [\[MP Tray Settings\] \(page 431\)](#)

4 Specify the type of paper loaded in the multipurpose tray using the operation panel.

➔ [Specifying Paper Size and Media Type \(page 152\)](#)

Printouts are wrinkled

ABC
123

Is the paper loaded correctly?

Load the paper correctly.

When loading paper in a cassette

1 Pull the cassette completely out of the machine.

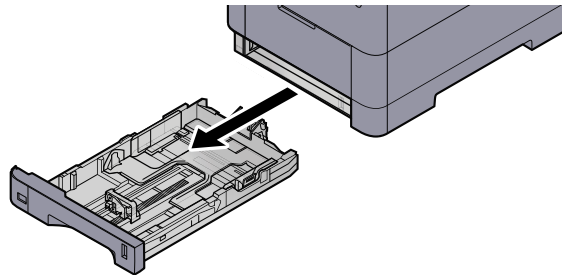

NOTE

When pulling the cassette out of the machine, ensure it is supported and does not fall out.

2 Adjust the cassette size.

- 1 Adjust the position of the paper width guides located on the left and right sides of the cassette. Press the paper width adjusting tab and slide the guides to the paper size required.

Paper sizes are marked on the cassette.

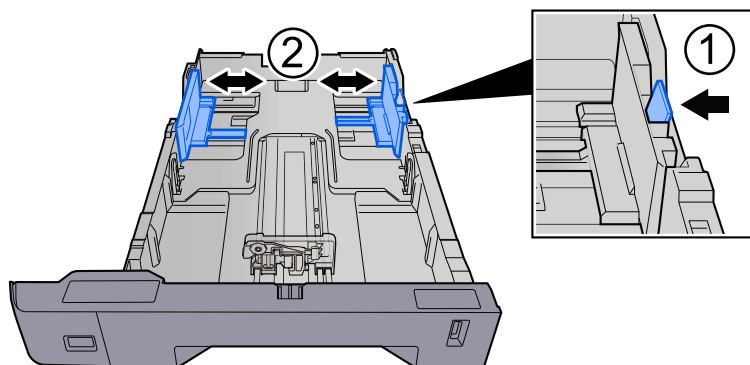

- 2 Adjust the paper length guide to the paper size required. Press the paper length adjusting tab and slide the guides to the paper size required.

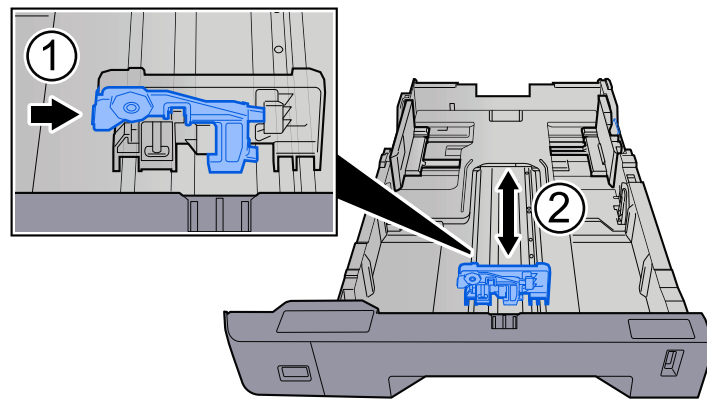

- 3 Turn the size dial so that the size of the paper you are going to use appears in the paper size window.

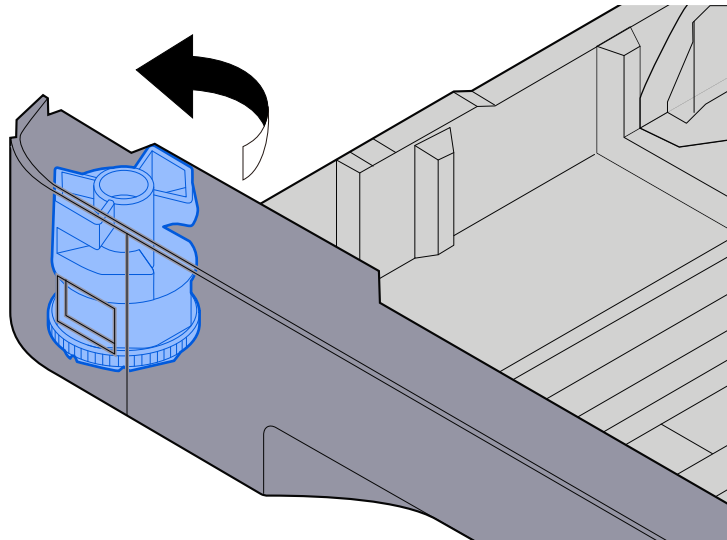

NOTE

Set the size dial to Other if you wish to use paper that is other than the Standard Size. In this case, it is necessary to set the paper size from the operation panel.

➔ [Specifying Paper Size and Media Type \(page 152\)](#)

3 Load paper.

- 1 Fan the paper, then tap it on a level surface to avoid paper jams or skewed printing.

2 Load the paper in the cassette.

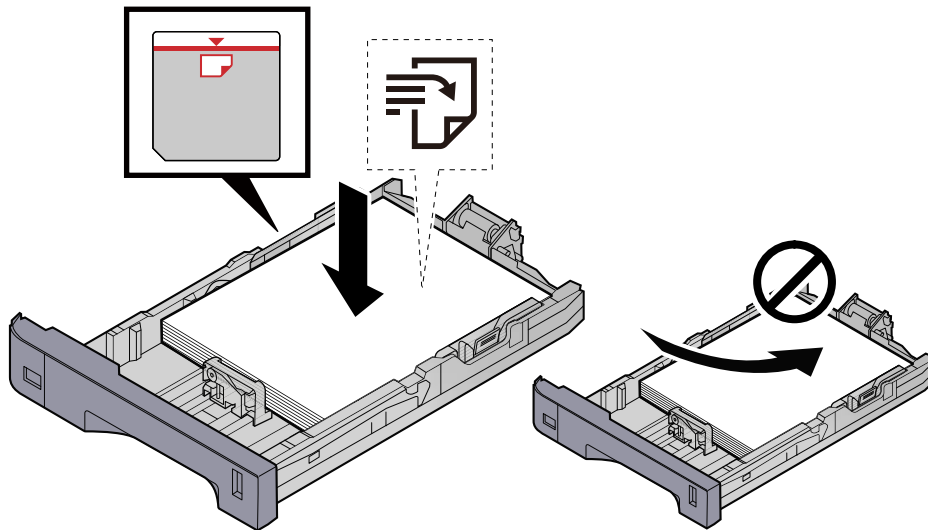

✔ **IMPORTANT**

- Load the paper with the print side facing up.
- After removing new paper from its packaging, fan out the paper before loading it in the cassettes.
➔ [Precaution for Loading Paper \(page 144\)](#)
- Before loading the paper, be sure that it is not curled or folded. Paper that is curled or folded may cause paper jams.
- Ensure that the loaded paper does not exceed the level indicator (see illustration above).
- If paper is loaded without adjusting the paper length guide and paper width guide, the paper may skew or become jammed.

4 Gently push the cassette back in.

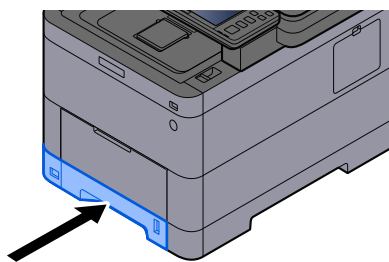



NOTE

There is a paper gauge on the right side of the front of the cassette. The display changes up and down to match the remaining amount of paper.

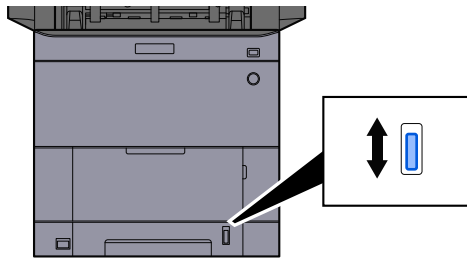

5 Specify the type of paper loaded in the cassette using the operation panel.

→ [Specifying Paper Size and Media Type \(page 152\)](#)

When loading paper in the multipurpose tray

1 Open the multipurpose tray.

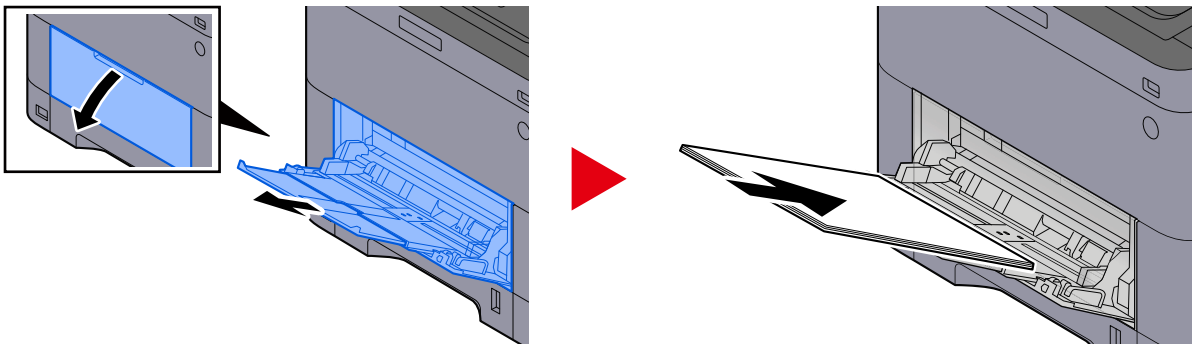

2 Adjust the multipurpose tray size.

Paper sizes are marked on the multipurpose tray.

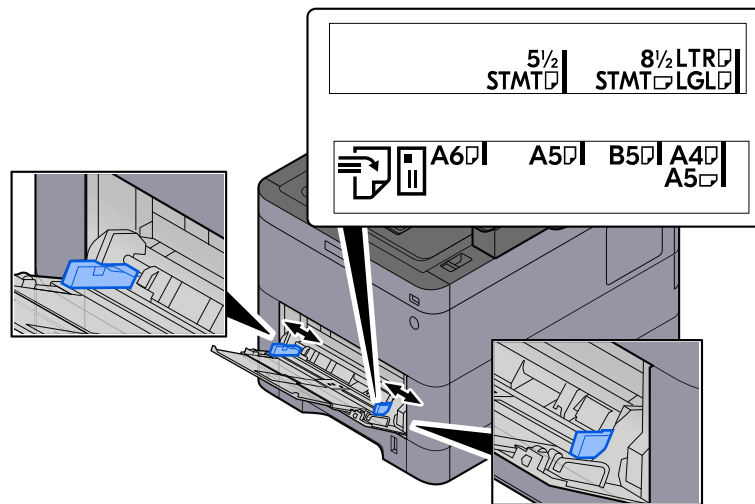

3 Load paper.

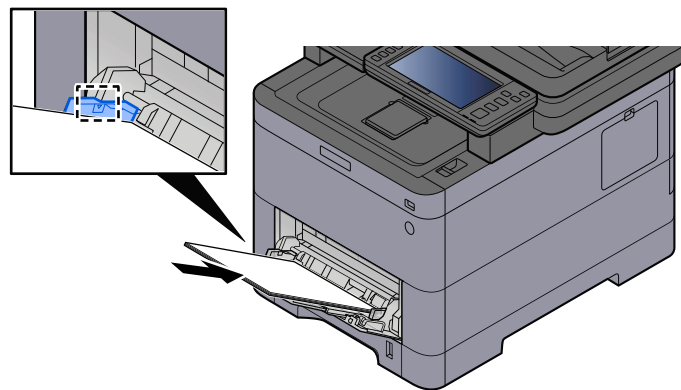

Insert the paper along the paper width guides into the tray until it stops.

After removing new paper from its packaging, fan the paper before loading it in the multipurpose tray.

➔ [Precaution for Loading Paper \(page 144\)](#)

✔ IMPORTANT

- When loading the paper, keep the print side facing up.
- Curled paper must be uncurled before use.
- When loading paper into the multipurpose tray, check that there is no paper left over in the tray from a previous job before loading the paper. If there is just a small amount of paper left over in the multipurpose tray and you want to add more, first remove the left-over paper from the tray and include it with the new paper before loading the paper back into the tray.
- If there is a gap between the paper and the paper width guides, readjust the guides to fit the paper in order to prevent skewed feeding and paper jams.
- Ensure that the loaded paper does not exceed the load limits.

When you load envelopes or cardstock in the multipurpose tray, load the paper with the print side facing up. For the procedure for printing, refer to the Printer Driver User Guide.

➔ [Printer Driver User Guide](#)

Example: When printing the address.

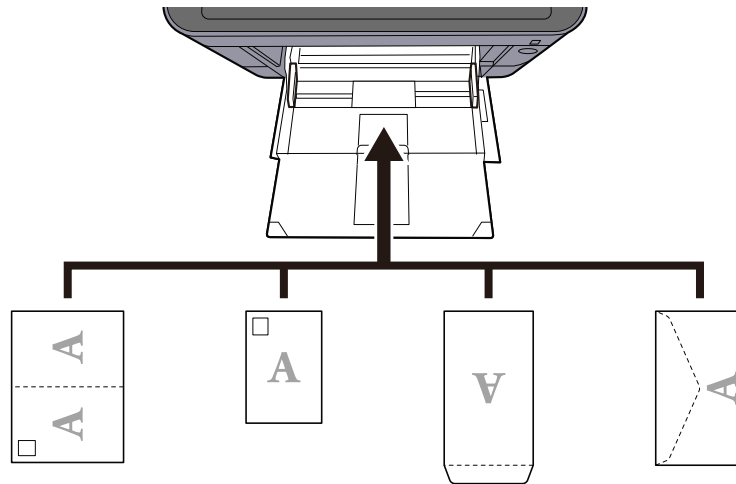

IMPORTANT

- Use unfolded Oufuku hagaki (Return postcard).
- How to load envelopes (orientation and facing) will differ depending on the type of envelope. Be sure to load it in correctly, otherwise printing may be done in the wrong direction or on the wrong face.

NOTE

When you load envelopes in the multipurpose tray, select the envelope type by referring to the following:

➔ [\[MP Tray Settings\] \(page 431\)](#)

4 Specify the type of paper loaded in the multipurpose tray using the operation panel.

➔ [Specifying Paper Size and Media Type \(page 152\)](#)

Remove the paper from the cassette once and change the loading direction by rotating the paper 180 degrees.

➔ [Precaution for Loading Paper \(page 144\)](#)

Is the paper damp?

Replace the paper with new paper.

➔ [Precaution for Loading Paper \(page 144\)](#)

Printouts are curled



Is the paper loaded correctly?

Load the paper correctly.

When loading paper in a cassette

1 Pull the cassette completely out of the machine.

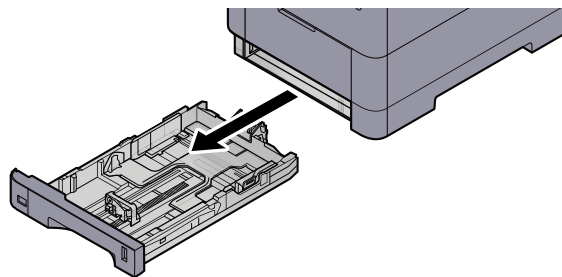

NOTE

When pulling the cassette out of the machine, ensure it is supported and does not fall out.

2 Adjust the cassette size.

- 1 Adjust the position of the paper width guides located on the left and right sides of the cassette. Press the paper width adjusting tab and slide the guides to the paper size required.

Paper sizes are marked on the cassette.

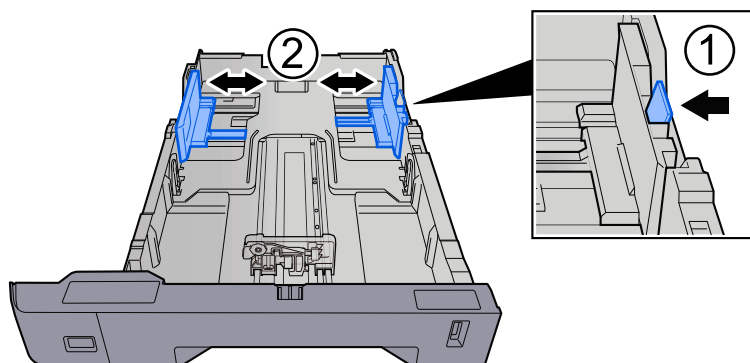

- 2 Adjust the paper length guide to the paper size required. Press the paper length adjusting tab and slide the guides to the paper size required.

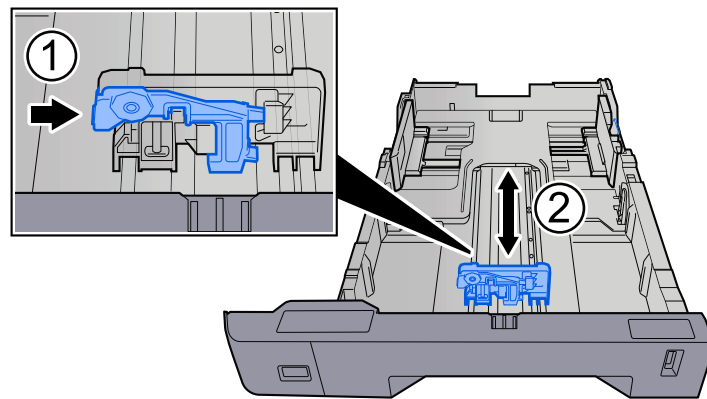

- 3 Turn the size dial so that the size of the paper you are going to use appears in the paper size window.

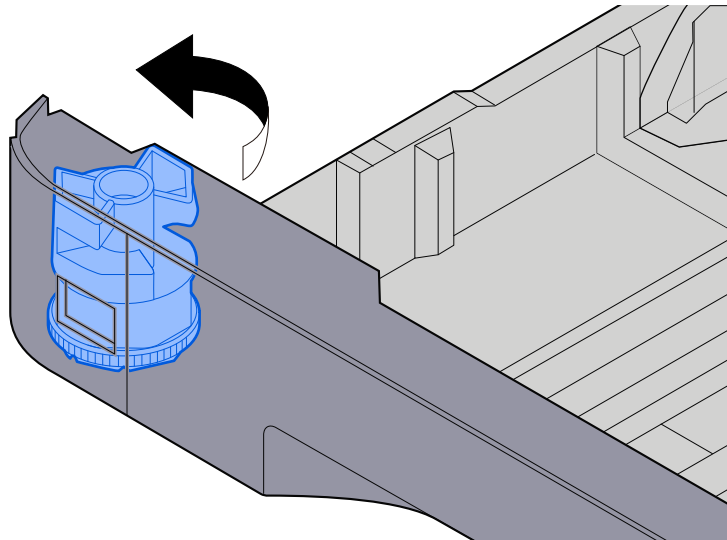

 **NOTE**

Set the size dial to Other if you wish to use paper that is other than the Standard Size. In this case, it is necessary to set the paper size from the operation panel.

➔ [Specifying Paper Size and Media Type \(page 152\)](#)

3 Load paper.

- 1 Fan the paper, then tap it on a level surface to avoid paper jams or skewed printing.

2 Load the paper in the cassette.

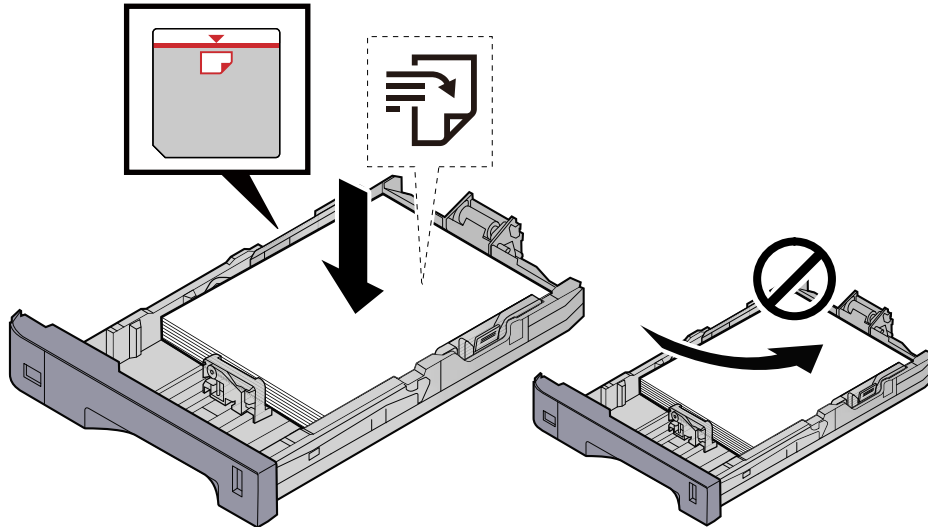

✔ **IMPORTANT**

- Load the paper with the print side facing up.
- After removing new paper from its packaging, fan out the paper before loading it in the cassettes.
➔ [Precaution for Loading Paper \(page 144\)](#)
- Before loading the paper, be sure that it is not curled or folded. Paper that is curled or folded may cause paper jams.
- Ensure that the loaded paper does not exceed the level indicator (see illustration above).
- If paper is loaded without adjusting the paper length guide and paper width guide, the paper may skew or become jammed.

4 Gently push the cassette back in.

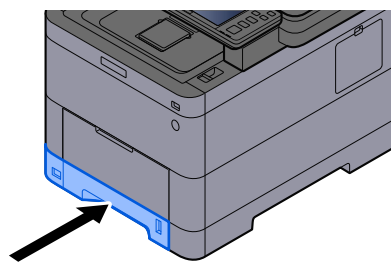



NOTE

There is a paper gauge on the right side of the front of the cassette. The display changes up and down to match the remaining amount of paper.

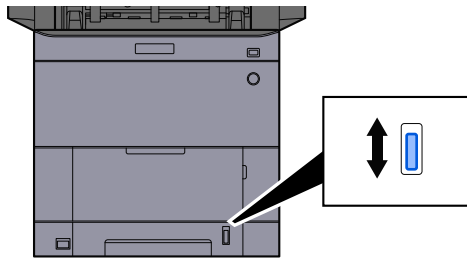

5 Specify the type of paper loaded in the cassette using the operation panel.

→ [Specifying Paper Size and Media Type \(page 152\)](#)

When loading paper in the multipurpose tray

1 Open the multipurpose tray.

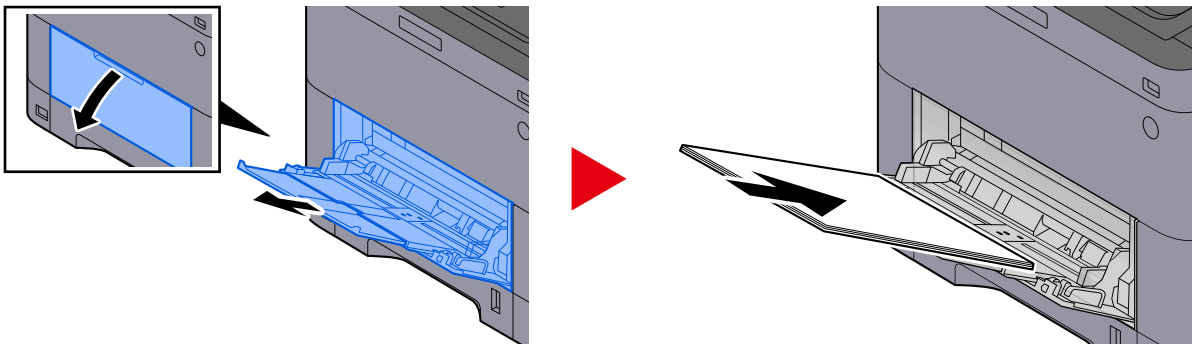

2 Adjust the multipurpose tray size.

Paper sizes are marked on the multipurpose tray.

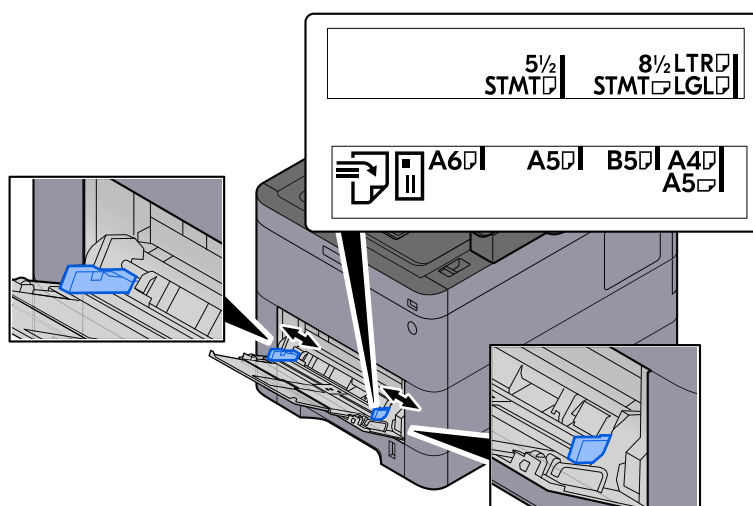

3 Load paper.

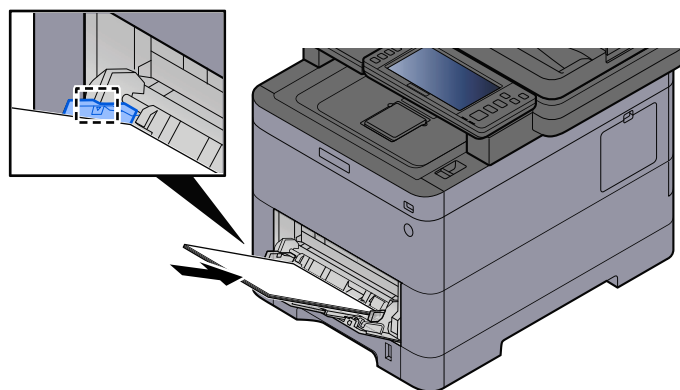

Insert the paper along the paper width guides into the tray until it stops.

After removing new paper from its packaging, fan the paper before loading it in the multipurpose tray.

➔ [Precaution for Loading Paper \(page 144\)](#)

✔ IMPORTANT

- When loading the paper, keep the print side facing up.
- Curled paper must be uncurled before use.
- When loading paper into the multipurpose tray, check that there is no paper left over in the tray from a previous job before loading the paper. If there is just a small amount of paper left over in the multipurpose tray and you want to add more, first remove the left-over paper from the tray and include it with the new paper before loading the paper back into the tray.
- If there is a gap between the paper and the paper width guides, readjust the guides to fit the paper in order to prevent skewed feeding and paper jams.
- Ensure that the loaded paper does not exceed the load limits.

When you load envelopes or cardstock in the multipurpose tray, load the paper with the print side facing up. For the procedure for printing, refer to the Printer Driver User Guide.

➔ [Printer Driver User Guide](#)

Example: When printing the address.

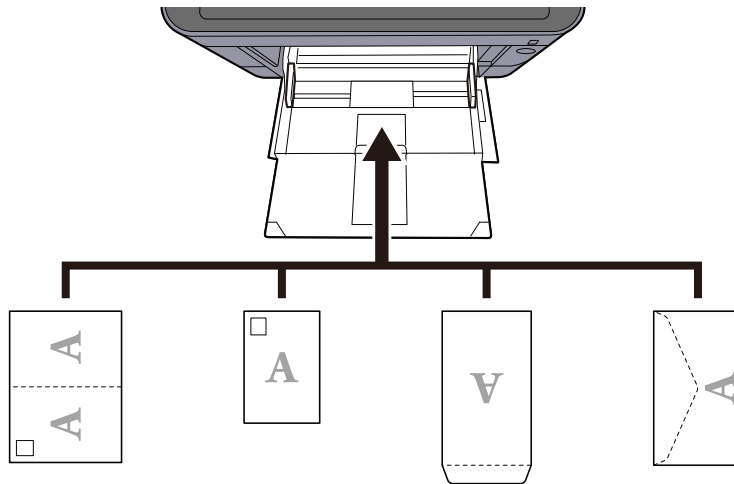

IMPORTANT

- Use unfolded Oufuku hagaki (Return postcard).
- How to load envelopes (orientation and facing) will differ depending on the type of envelope. Be sure to load it in correctly, otherwise printing may be done in the wrong direction or on the wrong face.

NOTE

When you load envelopes in the multipurpose tray, select the envelope type by referring to the following:

➔ [\[MP Tray Settings\] \(page 431\)](#)

4 Specify the type of paper loaded in the multipurpose tray using the operation panel.

➔ [Specifying Paper Size and Media Type \(page 152\)](#)

Remove the paper from the cassette once and reload the paper upside-down or change the loading direction by rotating the paper 180 degrees.

➔ [Precaution for Loading Paper \(page 144\)](#)

Is the paper damp?

Replace the paper with new paper.

Printer driver cannot be installed

Is the driver installed with the host name while Wi-Fi or Wi-Fi Direct function is available?

Specify the IP address instead of the host name.

→ [Installing Software \(page 96\)](#)

Is Level 3 selected in Security Quick Setup?

- 1 Acquire a root certificate for SSL communication from a trusted root certification authority. In Command Center RX, click [Security Settings] > [Certificates], and register the root certificate in [Root Certificate 1] to [Root Certificate 5].**
- 2 After installing the certificate, restart the PC.**
- 3 In Command Center RX, click [Network Settings] > [Protocols], and in [Other Protocols], set "SNMPv3" to [On].**
- 4 In Command Center RX, click [Management Settings] > [SNMP], and set "SNMPv3".**
- 5 Access the [Control Panel], then select [Devices and Printers], [Add a printer], and [The printer that I want isn't listed].**
- 6 Check [Select a shared printer by name], and enter the address of the printer.
E.g.: https://hostname:443/printers/lp1**
- 7 Select the desired printer and specify the printer driver.**

Cannot start printing

Is the machine plugged in?

Plug the power cord into an AC outlet.

Is the power turned on?

Turn the power switch on.

1 Turn the power switch on.

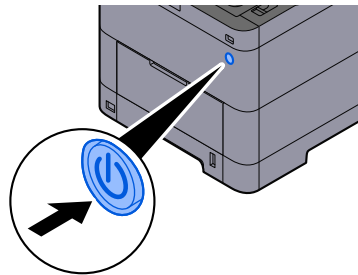

✔ IMPORTANT

When turning off the power switch, do not turn on the power switch again immediately. Wait more than 5 seconds, and then turn on the power switch.

Are the USB cable and network cable connected?

Make sure to connect the USB cable and network cable securely.

Connect the network cable

✔ IMPORTANT

If the power is on, turn the power switch off.

➔ [Power off \(page 50\)](#)

1 Connect the cable to the machine.

- 1 Connect the LAN cable to the network interface connector.

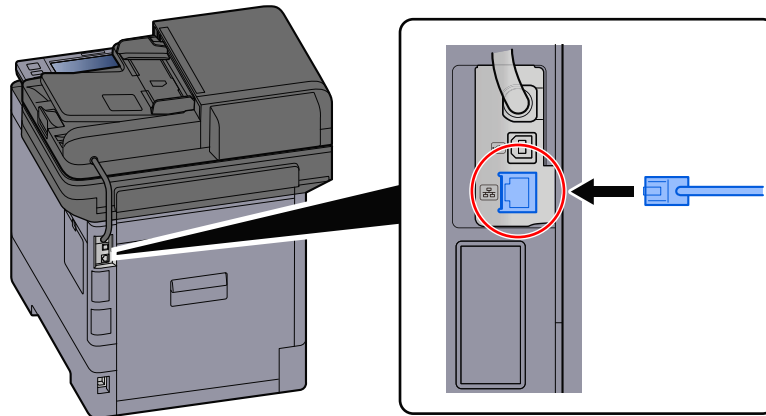

- 2 Connect the other end of the cable to the hub.

2 Power on the machine and configure the network.

- [Network Setup \(page 79\)](#)

Connect a USB cable to the machine.

✔ IMPORTANT

If the power is on, turn the power switch off.

- [Power off \(page 50\)](#)

1 Connect the cable to the machine.

- 1 Connect the USB cable to the USB interface connector.

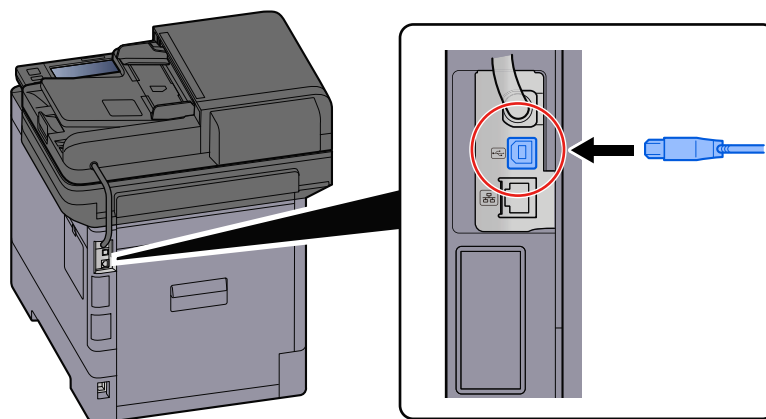

- 2 Connect the other end of the cable to the PC.

2 Power on the machine.

Is the print job paused?

Resume printing.

1 Display the screen.

- 1 Select the [Status / Job Cancel] key.

2 Select [Pause AllPrint Jobs] on the printing jobs status screen.

Printing is paused.

When resuming the printing of jobs that have been paused, select [Resume AllPrint Jobs] .

Are there a mixture of inaccessible addresses?

If you have configured wired and Wi-Fi networks with name resolution, you may have a mix of IP addresses (private addresses) on the other inaccessible network.

IMPORTANT

Only one host name and one domain name can be used on this machine. Please consider this limitation when setting the network operation.

1 [System Menu / Counter] key > [NetworkSettings] > "Others" > [Primary Network (Client)]

Select Wi-Fi, Wired or Optional Network as the network to use without restrictions.

- ➔ [Primary Network \(Client\) \(page 500\)](#)

2 [System Menu / Counter] key > [NetworkSettings] > "Network Settings" [Protocol Settings]

Please [Enable] either [Wired Network] or [Wi-Fi] and [Disable] the other.

- ➔ [Protocol Settings \(page 488\)](#)

3 In Command Center RX, change the settings for name resolution of NetBEUI, DNS, etc., or change the network environment settings.

- ➔ [Command Center RX User Guide](#)

Cannot print with USB drive / Does not recognize USB drive

Is the USB drive connected to the machine firmly?

Connect the USB drive firmly to the machine.

Are USB host settings set to [Block]?

1 Change the USB host setting to [Unblock]

[System Menu / Counter] key > [SecuritySettings] > "Interface Block Setting"

➔ [Interface Block Setting \(page 503\)](#)

Is the USB drive broken?

Use another USB drive.

While [Auto-IP] is already set to [On], the IP address is not assigned automatically

Is a value other than "0.0.0.0" entered for the link local address of TCP/IP(v4)?

1 Enter "0.0.0.0" in IP Address of TCP/IP(v4).

- 1 [System Menu / Counter] key > [NetworkSettings] > "Network Settings" [Wired Network Settings] > "TCP/IP Settings" [IPv4 Settings]
- 2 Enter "0.0.0.0" in IP Address.
➔ [TCP/IP \(IPv4\) setting \(page 80\)](#)

Cannot send via SMB

Is the network cable connected?

Connect the cable to the Machine and HUB securely.

1 Connect the cable to the machine.

- 1 Connect the LAN cable to the network interface connector.

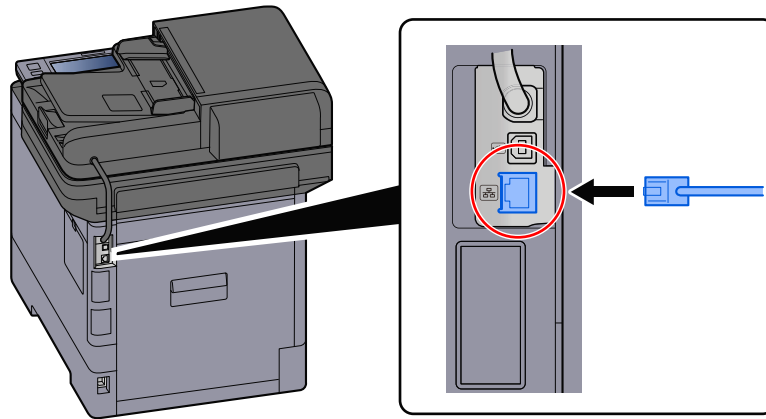

- 2 Connect the other end of the cable to the hub.

2 Power on the machine and configure the network.

- [Network Setup \(page 79\)](#)

Are the network settings on the machine configured correctly?

Check that TCP/IP is [On], and IPv4 or IPv6 is configured in accordance with the usage environment.

- [TCP/IP SettingsTCP/IP Settings \(page 484\)](#)

Are the SMB protocol and SMB settings for folder sending turned on?

1 Set the SMB protocol settings to On.

[System Menu / Counter] key > [NetworkSettings] > "Network Settings" [Protocol Settings] > [SMB Client (Transmission)] > ON

2 Set the SMB settings for folder sending to [On].

[System Menu / Counter] key > [FunctionSettings] > [Sending Job - Folder] > [SMB Settings] > ON

Are the host name, folder path, login user name, and login password of the destination computer correct?

- 1 [Home] key > [Send]**
- 2 In the destination screen for sending, select [Enter destination] > [SMB]**
- 3 Enter the destination information**

To directly specify the SMB folder, select [Folder Path Entry] and enter each item.



NOTE

When selecting On for "Entry Check for New Dest.", the re-entering screen for the destination information appears.

➔ [Re-enter new recipient information. \(page 274\)](#)

The table below explains the items to be entered.

Setting	Detail
Host Name	Computer name. Enter "Host Name" or "IP Address". To enter the IPv6 address, enclose the address in brackets []. Limited character count: 256 characters or less Example: [2001:db8:a0b:12f0::10] (Example: [2001:db8:a0b:12f0::10])
Port	Port number If the port number is not specified, the default port number is 445.
Folder Path	Share name Limited character count: 260 characters or less For example: scannerdata If saving in a folder in the shared folder: share name\folder name in shared folder
Login User Name	<ul style="list-style-type: none"> • If the computer name and domain name are the same User Name For example: james.smith. • If the computer name and domain name are different Domain name\User name For example: abcdnet\james.smith Limited character count: 64 characters or less When transmitting using the optional network interface (IB-37, IB-38 or IB-51), only alphanumeric characters are allowed. Also, if the computer name and domain name are different because "\" is not available, use @ to enter the user name in the following format: User name@Domain name (Example: james.smith@abcdnet)
Login Password	Logon password. Limited character count: 128 characters or less Upper case and lower case letters are distinguished (case sensitive).

You can search for a folder on a PC on the network. Select [Search Folder from Network] or [Search Folder by Host Name]. Select the folder from the Search Results list.



NOTE

- If you selected [Search Folder from Network], you can search all PCs on the network for a destination.
 - If you selected [Search Folder by Host Name], you can search for a destination from among PCs that are connected to the network by entering "Domain/Workgroup Name"/"Host Name".
 - A maximum of 500 addresses can be displayed. Select the host name (PC name) that you want to specify in the screen that appears, and select [OK]. The login user name and login password entry screen appears.
 - After you enter the login user name and login password of the destination PC, the shared folders appear. Select the folder that you want to specify and select [OK]. The address of the selected shared folder is set.
-

Are the folder sharing settings configured correctly?

Check the sharing settings and access permissions in the folder properties.

- 1 Right-click the shared folder and click [Properties] → [Security] tab.**
- 2 Select a user and make sure the user you entered in the group name or user name field is displayed**
- 3 Make sure that [Allow] is checked off for "Modify" and "Read & Execute"**
- 4 Click the [Close] button.**

→ [Creating a Shared Folder, Making a Note of a Shared Folder \(page 158\)](#)

Is the selected interface selected as the Primary Network?

Make sure the selected interface is selected as the Primary Network.

- 1 [System Menu / Counter] key > [NetworkSettings] > "Others" [Primary Network (Client)]**



NOTE

[Primary Network (Client)] is displayed when the optional Network Interface Kit (IB-50) or Wireless Network Interface Kit (IB-37/IB-38/IB-51) is installed.

- 2 Specify the host name or IP address of the interface selected as the Primary Network, or reconfigure it to the interface you want to use.**

For example, if you selected the [Optional Network] optional network as the Primary Network, specify the host name or IP address of IB-50 or IB-51.

Are the exception settings for Windows Firewall configured correctly?

Make sure that the exception settings for Windows Firewall are configured correctly.

- 1** From the desktop charm, select [Settings]→ [Control Panel]→ [System and Security]→ [Allow applications through Windows Firewall]
- 2** Make sure [File and Printer Sharing] is checked off
- 3** Go back to the [System and Security] screen and select [Check Firewall Status] of Windows Defender Firewall
- 4** Click [Advanced Setting]→ [Inbound Rules]
- 5** Confirm that the registered exception settings (rules) are displayed in the list.
→ [Configuring Windows Firewall \(page 163\)](#)

Are the time settings of the machine, domain server, and data destination PC all synchronized?

Synchronize the time settings of the machine domain server, and the data destination PC.

Is "Send error." displayed on the screen?

For details, refer to the following:

- ["Send error." is displayed \(page 663\)](#)

Cannot send via email

Is the email send size limited in the SMTP server registered in this machine?

Check email sending size in Command Center RX.

- 1 Launch your Web browser.**
- 2 In the address or location bar, enter the machine's IP address or the host name.**
- 3 Log in with administrator privileges.**
- 4 Click [E-mail] of the [Functions] Menu.**
- 5 Check whether a restriction value is entered in [E-mail Size Limit] of "E-mail Send Settings", and change it as necessary.**
- 6 Click [Submit].**
 - ➔ [SMTP and E-mail Settings \(page 125\)](#)

The machine is emitting steam in the area around the paper ejection slot

Is the temperature in the room where the machine is running low? Or was damp paper used?

Depending on the machine's printing environment and the condition of the paper, the moist contained in the paper may evaporate due to the heat generated during printing, and the water vapor emitted may look like smoke.

There is no problem, and you can continue printing. If the steam concerns you, raise the room temperature or replace the paper with a new dryer paper.

Even after replacing the toner container, the message to replace the toner container does not disappear

Corrective Actions

Make sure the waste toner cover, rear cover, and other covers are closed.

Cannot create searchable PDF

Is the original set correctly?

Check that the original orientation is correct.

Is the proper language to extract selected?

Check the settings of the language to extract.

1 [System Menu / Counter] key > [FunctionSettings] > [Function Defaults] > [Send/Store] > [Primary OCR Language]

2 **Check the default language of the text to be extracted**

If the language to be extracted is different, select the language to extract from the options on the touch panel.

➔ [OCR Text Recognition \(Option\) \(page 376\)](#)

Cannot search a text you want to search on a PDF file

Have you set [OCR Text Recognition] for [File Format]?

Set [File Format] with [OCR Text Recognition].

- 1 **Select [OCR Text Recognition] > On.**

Are the texts on the scanned document blurred or faded?

Set [Density] to a darker setting.

- 1 **Select [Density] from the [Color/ImageQuality] tab, set the density in the range [1] to [4]**

Is the background color of the scanned document too dark and make the texts difficult to see?

Make the density setting lighter.

- 1 **From the [Color/ImageQuality] tab, select [Background Density Adj.], and set it to [Auto]**

 **NOTE**

The background density can also be adjusted by selecting [Manual].

➔ [Density \(page 332\)](#)

➔ [Background Density Adj. \(page 342\)](#)

- 2 **Select [Density] from the [Color/ImageQuality] tab, set the density in the range [-4] to [-1]**

Aren't the texts and images on the back page of the scanned original bleeding-thru?

Set [Prevent Bleed-thru] to On.

- 1 **Select [Prevent Bleed-thru] from the [Color/ImageQuality] tab and set it to On.**
➔ [Prevent Bleed-thru \(page 344\)](#)

Cannot find the machine with WSD

Are you searching for this machine by specifying the IP address or host name?

For security reasons, [HTTP] protocol is set to off, and therefore you cannot search by IP address or host name.

Printed Image Trouble

Printouts are totally too light

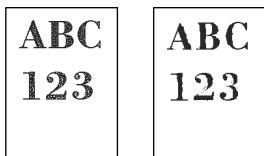

Is the paper damp?

Replace the paper with new paper.

Is the media type set correctly?

Check if the media type setting is correct.

- 1 **[System Menu / Counter] key > [DeviceSettings] > [Paper Feeding] > [Media Type Setting]**
- 2 **Check the weight (paper thickness) for the paper type and change it to the correct value.**
→ [\[Media Type Setting\] \(page 434\)](#)

Are you changing the density?

Set to an appropriate density.

- 1 **Set the density in the range [-4] to [4]**
→ [Density \(page 332\)](#)



NOTE

You can configure the density settings using [System Menu / Counter] key > [Adjustment/Maintenance] > "Image Adjustment" > [Density Adjustment].

→ [Density Adjustment \(page 513\)](#)

Have you set EcoPrint?

Set [EcoPrint] to [Off].

- 1 **[System Menu / Counter] key > [FunctionSettings] > [Printer]**
- 2 **[EcoPrint] > Off**

Developer refresh needs to be performed.

1 Display the screen.

- 1 [System Menu / Counter] key > [Adjustment/Maintenance] > "Image Adjustment" [Image Adjustment]

2 Perform the Developer Refresh

- 1 Perform the Developer Refresh.
Developer Refresh begins.



NOTE

Waiting time may be longer when the toner is refilled during developer refresh.

Laser scanner cleaning needs to be performed.

1 Display the screen.

- 1 [System Menu / Counter] key > [Adjustment/Maintenance] > "Image Adjustment" [Image Adjustment]

2 Perform the laser scanner cleaning.

- 1 Perform the Laser Scanner Cleaning.
Laser Scanner Cleaning begins.

White background parts of the image appear to have a slight overall coloration

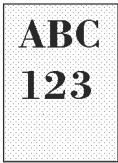

Have you changed the density?

Select appropriate density level.

1 Set the density in the range [-4] to [4]

→ [Density \(page 332\)](#)



NOTE

Density can also be set from [System Menu / Counter] key > [Adjustment/Maintenance] > "Image Adjustment" > [Image Adjustment].

→ [Density Adjustment \(page 513\)](#)

Developer refresh needs to be performed.

1 Display the screen.

1 [System Menu / Counter] key > [Adjustment/Maintenance] > "Image Adjustment" [Image Adjustment]

2 Perform the Developer Refresh

1 Perform the Developer Refresh.
Developer Refresh begins.



NOTE

Waiting time may be longer when the toner is refilled during developer refresh.

Drum refresh needs to be performed.

1 Display the screen.

1 [System Menu / Counter] key > [Adjustment/Maintenance] > "Image Adjustment" > [Image Adjustment]

2 Perform the Drum Refresh.

1 Perform the Drum Refresh.
Drum Refresh begins.

Copies have a moire pattern (dots grouped together in patterns and not aligned uniformly)

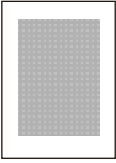

Is it an original with a photo printed on it?

Check the content structure of the original and change it to an appropriate image quality.

- 1** Select a [Original Image] for each function
- 2** Select [Photo].
 - ➔ [Original Image \(page 333\)](#)

Texts are not clearly printed

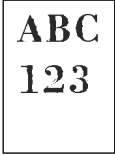

Have you selected appropriate image quality for the original?

Check the content structure of the original and change it to an appropriate image quality.

- 1** Select a [Original Image] for each function
- 2** Select the image quality that matches the type of the original
 - [Original Image \(page 333\)](#)

Black or color dots appear on the white background



Is the original holder or the platen dirty?

Wipe the inside of the document processor and the platen with a soft cloth dampened with alcohol or mild detergent.

✔ IMPORTANT

Do not use thinner or other organic solvents.

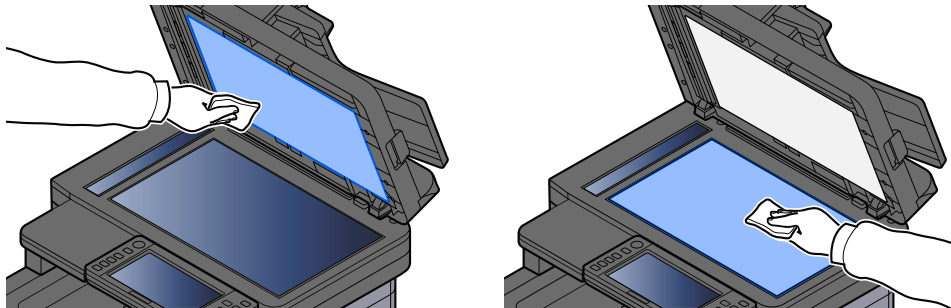

Developer refresh needs to be performed.

1 Display the screen.

- 1 [System Menu / Counter] key > [Adjustment/Maintenance] > "Image Adjustment" [Image Adjustment]

2 Perform the Developer Refresh

- 1 Perform the Developer Refresh.
Developer Refresh begins.

NOTE

Waiting time may be longer when the toner is refilled during developer refresh.

Printed images are fuzzy or cut off

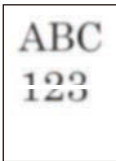

Are you using the machine in a place with high humidity or drastic temperature and humidity fluctuations?

Use the machine in an environment with appropriate humidity.

Drum refresh needs to be performed.

1 Display the screen.

- 1 [System Menu / Counter] key > [Adjustment/Maintenance] > "Image Adjustment" > [Image Adjustment]

2 Perform the Drum Refresh.

- 1 Perform the Drum Refresh.
Drum Refresh begins.

Printed images are shifted



Is the original set correctly?

- When setting the original on the platen, make sure to align the original with the original size indicator plate.
 - ➔ [Placing Originals on the Platen \(page 225\)](#)
- When loading the original in the document processor, make sure to align the original width guides before loading the original.
 - ➔ [Loading Originals in the Document Processor \(page 228\)](#)

Is the paper loaded correctly?

Adjust the paper length guide and width guide of the cassette to fit the paper size.

- ➔ [Loading in the Cassettes \(page 146\)](#)

Printed images have vertical lines

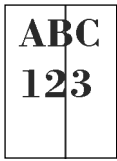

Is the slit glass dirty?

When using the document processor, clean the slit glass surface and the reading guide with the dry cloth.

IMPORTANT

Do not use water, soap or solvents for cleaning.

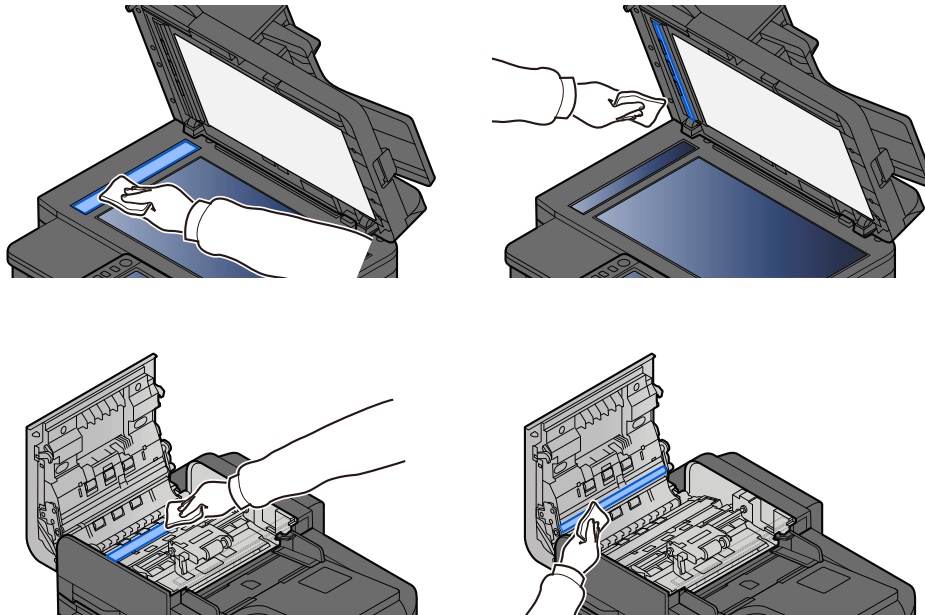

Laser scanner cleaning needs to be performed.

1 Display the screen.

1 [System Menu / Counter] key > [Adjustment/Maintenance] > "Image Adjustment" [Image Adjustment]

2 Perform the laser scanner cleaning.

1 Perform the Laser Scanner Cleaning.
Laser Scanner Cleaning begins.

Dirt on the top edge or back of the paper

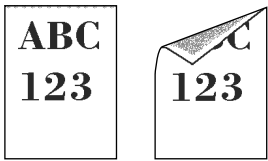

Is the inside of the machine dirty?

Open the Rear Cover 1, and if the inside of the Machine is dirty with toner or the like, wipe it off with a soft, dry cloth.

Part of the image is periodically faint or shows white lines



Is the Rear Cover 1 tightly closed?

Open the Rear Cover 1 and close it again.

Drum refresh needs to be performed.

1 Display the screen.

- 1 [System Menu / Counter] key > [Adjustment/Maintenance] > "Image Adjustment" > [Image Adjustment]

2 Perform the Drum Refresh.

- 1 Perform the Drum Refresh.
Drum Refresh begins.

Developer refresh needs to be performed.

1 Display the screen.

- 1 [System Menu / Counter] key > [Adjustment/Maintenance] > "Image Adjustment" [Image Adjustment]

2 Perform the Developer Refresh

- 1 Perform the Developer Refresh.
Developer Refresh begins.



NOTE

Waiting time may be longer when the toner is refilled during developer refresh.

The print on the back page bleeds through



- 1** Select **[Prevent Bleed-thru]** from the **[Color/ImageQuality]** tab and set it to **On**.



NOTE

Prevent Bleed-thru can also be set from [System Menu / Counter] key > [FunctionSettings] > [Function Defaults] > [Copy/Print] > [Prevent Bleed-through (Copy)].

A lighter version of the previous image remains and is repeatedly printed



The GS settings need to be adjusted.

1 Configure the settings for GS.

- 1 Select the [System Menu / Counter] key > [Adjustment/Maintenance] > "Others" > [GS].
Increase the value one level from the current value.
- 2 Select the [System Menu / Counter] key > [Adjustment/Maintenance] > "Image Adjustment" [Image Adjustment].
Perform only calibration.
- 3 Print a document and confirm the image quality.
Increase the value until the image is improved.



NOTE

If there is still no improvement, return the setting to the original value.

2 If white dots appear in the improved image, decrease the value by one level.

3 If the white background of the improved image appears colored, proceed to the next step. If there is no unnecessary coloring, finish editing.

4 Configure the settings for MC.

- 1 Select the [System Menu / Counter] key > [Adjustment/Maintenance] > "Others" > [MC].
Increase the value one level from the current value.
- 2 Select the [System Menu / Counter] key > [Adjustment/Maintenance] > "Image Adjustment" [Image Adjustment].
Perform only calibration.
- 3 Print the document and confirm the image quality.
Increase the value until the image is improved.



NOTE

If there is still no improvement, return the setting to the original value.

5 If white dots appear in the improved image, decrease the value by one level.

Color Printing Trouble

Color drift occur



Calibration needs to be performed.

1 Display the screen.

- 1 [System Menu / Counter] key > [Adjustment/Maintenance] > "Image Adjustment" [Image Adjustment]

2 Perform the calibration.

- 1 Perform the calibration.
Calibration begins.

Color registration (automatic correction) needs to be performed

1 Load paper.

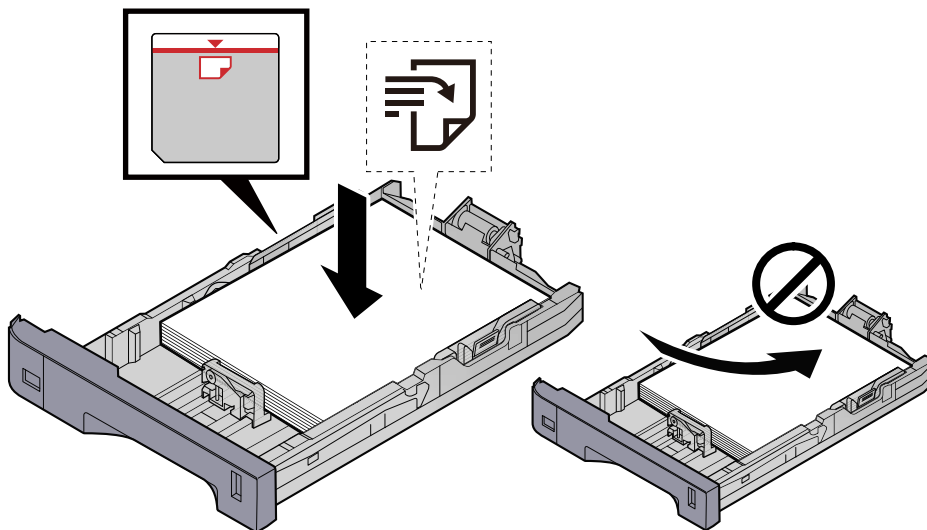

 **IMPORTANT**

- Load the paper with the print side facing up.
- After removing new paper from its packaging, fan out the paper before loading it in the cassettes.
 → [Precaution for Loading Paper \(page 144\)](#)
- Before loading the paper, be sure that it is not curled or folded. Paper that is curled or folded may cause paper jams.
- Ensure that the loaded paper does not exceed the level indicator (see illustration above).
- If paper is loaded without adjusting the paper length guide and paper width guide, the paper may skew or become jammed.

2 Display the screen.

- 1 [System Menu / Counter] key > [Adjustment/Maintenance] > "Image Adjustment" [Color Registration - Auto]

3 Print the chart

- 1 Select [Start].
A chart is printed.

Chart Example

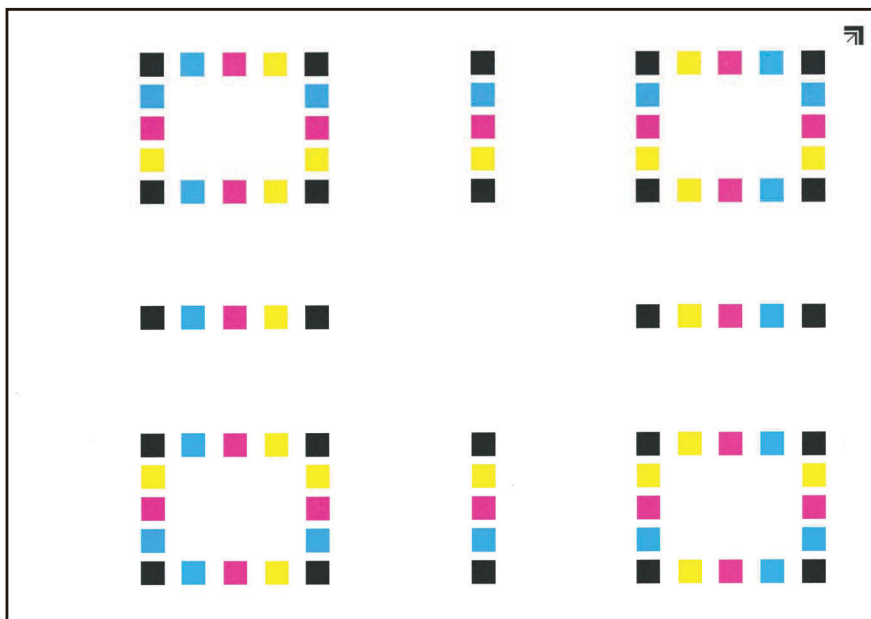

4 Perform the color registration.

- 1 As shown in the illustration, place the printed side down on the platen with the edge with the arrows toward the back.

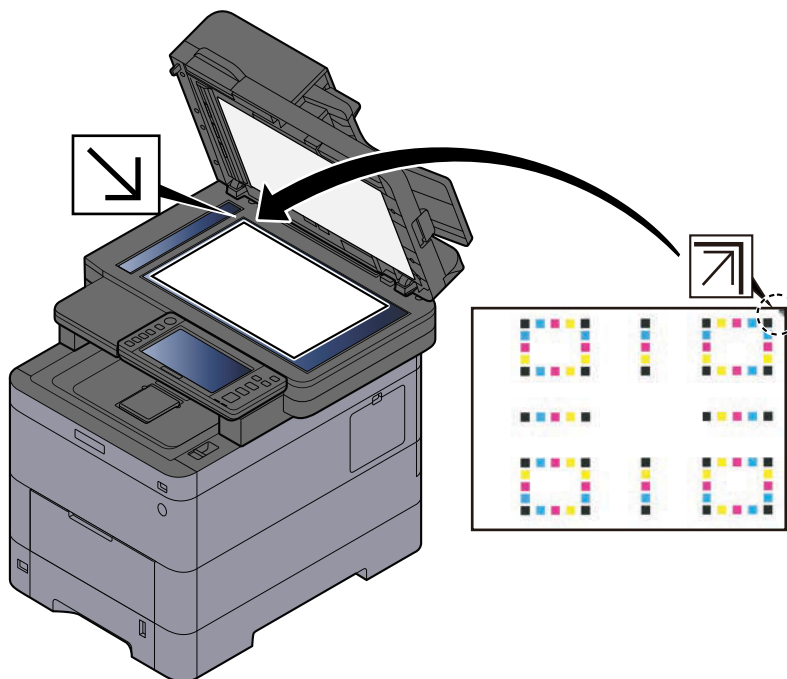

- 2 Select [Start] to scan the chart.
When scanning is finished, color printing position correction starts.
- 3 Select [OK] after color registration is complete.

Color registration (manual correction) needs to be performed

1 Load paper.

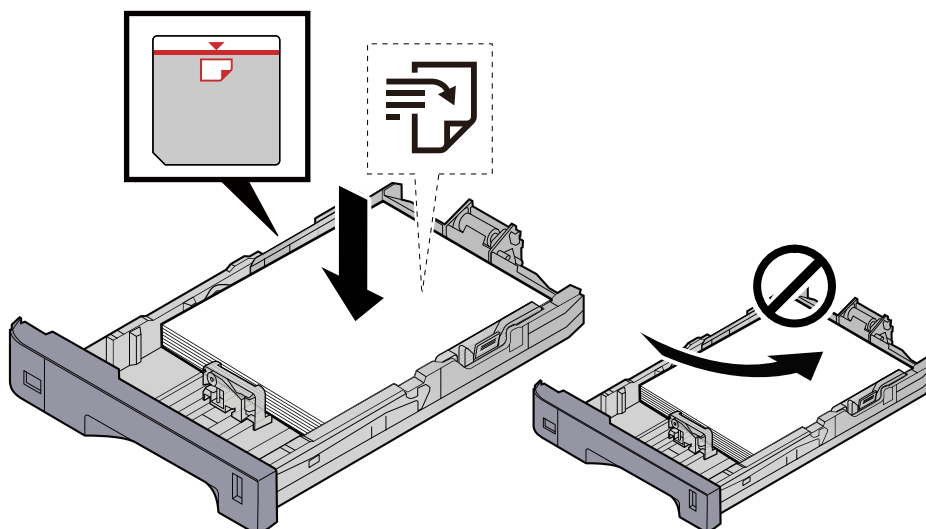

✓ IMPORTANT

- Load the paper with the print side facing up.
- After removing new paper from its packaging, fan out the paper before loading it in the cassettes.
 → [Precaution for Loading Paper \(page 144\)](#)
- Before loading the paper, be sure that it is not curled or folded. Paper that is curled or folded may cause paper jams.
- Ensure that the loaded paper does not exceed the level indicator (see illustration above).
- If paper is loaded without adjusting the paper length guide and paper width guide, the paper may skew or become jammed.

2 Display the screen.

- 1 [System Menu / Counter] key > [Adjustment/Maintenance] > "Image Adjustment" [Color Registration - Manual]

3 Print the chart.

- 1 Select [Print Chart].

A chart is printed. On the chart, for each of M (magenta), C (cyan) and Y (yellow), charts for H-1 to 5 and V-1 to 5 are printed.

Chart Example

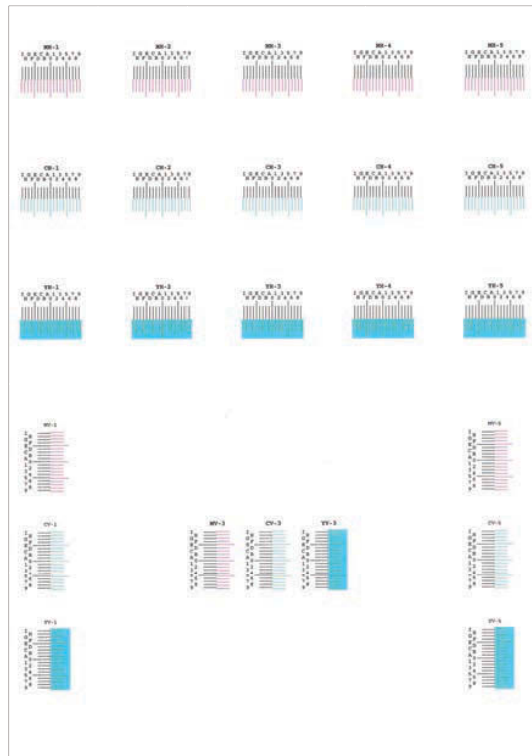

4 Enter the appropriate value.

- 1 Find the location on each chart where 2 lines most closely match. If this is the 0 position, registration for that color is not required. For the illustration, B is the appropriate value.

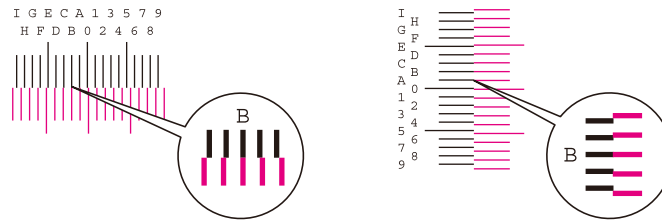

From charts H-1 to H-5, read the values from H-1 to H-5.

From charts V-1 to V-5, read only the values from V-3 (center).

- 2 Select [Registration].
- 3 Select the chart to be corrected.
- 4 Select the values read from the chart.
- 5 Repeat steps 3 and 4 to enter the registration values for each chart.
- 6 Select [Start] after all values have been entered. Color registration begins.
- 7 Select [OK] after color registration is complete.

Colors appear different than you anticipated

Have you selected appropriate image quality for the original?

Check the content structure of the original and change it to an appropriate image quality.

- 1 Select a [Original Image] for each function**
- 2 Select the image quality that matches the type of the original**
 - ➔ [Original Image \(page 333\)](#)

Is color copy paper set in the paper source?

Set the color copy paper.

Calibration needs to be performed.

- 1 Display the screen.**
 - 1** [System Menu / Counter] key > [Adjustment/Maintenance] > "Image Adjustment" [Image Adjustment]
- 2 Perform the calibration.**
 - 1** Perform the calibration.
Calibration begins.

Is the color balance appropriate (in the case of copying)?

Adjust the color balance.

- 1 From the [Color/ImageQuality] tab, select [Color Balance], and set it to [On]**
- 2 Move the cursor of the color to be adjusted ("cyan", "magenta", "yellow", "black") to adjust each color.**

(For printing) Is the color adjustment appropriate?

Adjust the color with the printer driver.

- ➔ **Printer Driver User Guide**

The color toner is empty

If you want to continue printing in black and white, follow these steps:

- 1 [System Menu / Counter] key > [DeviceSettings] > [Toner Settings]
- 2 [Color Toner Empty Action] > [Print in Black & White]



NOTE

This setting is not valid when the optional Fiery Controller is installed.

Remote Operation

This function enables the system administrator to explain how to operate the panel and troubleshoot to user, by accessing operation panel of the machine at remote using browser and VNC software.

Executing Remote Operation from Browser

The supported Browser is as follows. We recommend the latest version of browser to use Remote Operation.

- Google Chrome (Version 21.0 or later)
- Microsoft Edge
- Mozilla Firefox (Version 14.0 or later)
- Safari (Version 5.0 or later)

This section describes the procedure for performing remote operations from Command Center RX using Google Chrome.



NOTE

To execute Remote Operation using other browsers, refer to the following:

- ➔ [Command Center RX User Guide](#)

1 Display the screen

- 1 [System Menu / Counter] key > [NetworkSettings] > "Network Settings" [Protocol Settings]

2 Set [Enhanced VNC (RFB) over TLS] to On.

- ➔ [Protocol Settings \(page 488\)](#)



NOTE

You can configure the protocol settings using Command Center RX.

- ➔ [Command Center RX User Guide](#)

3 Configure settings for remote operation.

- 1 [System Menu / Counter] key > [NetworkSettings] > "Connectivity" [Remote Operation] > ON

2 Select from [Off], [Use Password], [Administrator Only]

When you select [Use Password], enter the password in "Password" and "Confirm Password", then select [OK].

➔ [Remote Operation \(page 500\)](#)



NOTE

You can configure settings for remote operation using Command Center RX.

➔ **Command Center RX User Guide**

4 **Restart the machine.**

➔ [Restart Entire Device \(page 500\)](#)

5 **Start up the browser.**

Specify https:// [Host name of this Machine] and start Command Center RX.

➔ [Accessing Command Center RX \(page 122\)](#)

6 **[Device Information / Remote Operation] > [Remote Operation]**

7 **Click [Start].**



NOTE

- If the user is logged in to the device, the permission confirmation screen will be displayed on the operation panel. Select [Yes].
 - If pop-up blocking of the browser occurs during connection of the Remote Operation, select Always allow pop-ups from https:// [host name], and click [Completed]. Perform [Start] after waiting 1 minute or more.
-

When the Remote Operation is started up, the operation panel screen will be displayed on the system administrator's or user's PC screen.

Executing Remote Operation from VNC Software

1 **Display the screen**

1 [System Menu / Counter] key > [NetworkSettings] > "Network Settings" [Protocol Settings]

2 **Set "Enhanced VNC (RFB)" to On.**

➔ [Protocol Settings \(page 488\)](#)



NOTE

- If "VNC (RFB) over TLS" is set to On, the communication is encrypted.
- You can configure the protocol settings using Command Center RX.

➔ **Command Center RX User Guide**

3 Startup the remote operation.

- 1 Start up the VNC software.
- 2 Enter the following format separated by a colon to start up the remote operation.
"IP address: port number"



NOTE

When setting "VNC (RFB)" to On in step 2, the default port number is 9062. When "VNC (RFB) over TLS" is set to On, the default port number is 9063.

➔ [Protocol Settings \(page 488\)](#)

Responding to Messages

If the touch panel or the computer displays any of these messages, follow the corresponding procedure.

NOTE

When contacting us, the serial number will be necessary. To check the serial number, refer to the following:

➔ [Checking the Equipment's Serial Number \(page 2\)](#)

"Access point was not detected." is displayed

Check if the access point has been set correctly.

"Add paper to cassette #." is displayed

Is the indicated cassette out of paper?

- Load paper.
 - ➔ [Loading in the Cassettes \(page 146\)](#)
- Select paper from another paper feed source.
- Select [Continue] to change the paper and print.

"Add paper in Multipurpose Tray." is displayed

Has the paper run out in the displayed paper source?

- Load paper.
 - ➔ [Loading in the Cassettes \(page 146\)](#)
 - ➔ [Loading Paper in the Multipurpose Tray \(page 150\)](#)
- Select paper from another source.
- Select [Continue] to change the paper and print.

"Adjusting Scanner." is displayed

The machine is in adjustment mode to maintain its quality. Please wait.

"Box limit exceeded." is displayed

Is [End] displayed on the screen?

Jobs cannot be saved because the specified box is full. The job will be canceled.

Select [End].

Print or delete the original in the box, and then try again.



If Auto Error Clear is set to [On], the process will resume automatically after a set period of time. For details, refer to the following:

➔ [Auto Error Clear \(page 440\)](#)

"Broadcast error" is displayed

An error occurred while broadcasting.

The job is canceled. Select [End].

"Calibrating..." is displayed

The machine is in adjustment mode to maintain its quality. Please wait.

"Cannot connect to Authentication Server." is displayed

Does the machine time match the server's time?

- Set the machine time to match the server's time

➔ [Setting Date and Time \(page 78\)](#)

Is it properly registered with the authentication server?

- Enable User Login Administration.

➔ [Enable User Login Administration \(page 521\)](#)

- Set the network authentication server.

- Check the connection status with the server.
- Confirm that the computer name and password for the authentication server are correct.

Is the machine connected to the network correctly?

➔ [Connecting LAN Cable \(page 48\)](#)

➔ [Network Setup \(page 79\)](#)

NOTE

If Auto Error Clear is set to [On], the process will resume automatically after a set period of time. For details, refer to the following:

➔ [Auto Error Clear \(page 440\)](#)

"Cannot connect to Server." is displayed

Check the connection status with the server.

"Cannot connect." is displayed

Wi-Fi or Wi-Fi Direct connection could not be completed.

Check the settings and signal conditions.

➔ [Wi-Fi Direct Settings \(page 477\)](#)

➔ [Wi-Fi Settings \(page 478\)](#)

"Cannot duplex print on this paper." is displayed

Have you selected a size or type of paper that cannot be duplex printed?

- Select [Continue] to cancel duplex printing and continue printing.
- Select paper from a different paper source and press [Continue] to change the paper for printing.
- To cancel, select [Cancel].

"Cannot perform remote printing." is displayed

Remote printing is prohibited.

The job is canceled. Select [End].

"Cannot print the specified number of copies." is displayed

Only one copy is available.

- Select [Continue] to continue printing.
- Select [Cancel] to cancel the job.

"Cannot process this job." is displayed

Restricted by the authorization settings.

The job is canceled. Select [End].

Restricted by the job accounting.

The job is canceled. Select [End].



If Auto Error Clear is set to [On], the process will resume automatically after a set period of time. For details, refer to the following:

➔ [Auto Error Clear \(page 440\)](#)

"Cannot read data in this ID card." is displayed

In registration process, the ID card information was not read correctly.

Hold the IC card over the IC card reader again. If the same message is displayed again, the IC card may not be compatible with this product. Replace it with another IC card.

"Cannot recognize the ID card reader." is displayed

- Check if the USB connector of your IC card reader is correctly connected to the main unit.
- If [USB HOST] in [Interface Block Setting] is set to [Block], change it to [Unblock].

"The following parts or functions have been failure." is displayed

Follow the displayed instructions.

"Cannot use following functions due to scanner failure. >> Copy, Send, Fax, Storing in Box" is displayed

The machine's scanner is out of order.

Contact your service representative. You can still use the print function.

"Cannot use following functions due to printer failure. >> Copy, Fax, Printing from Box, Print Report" is displayed

The machine's printer is out of order.

Please contact the service representative. You can still use the scanner function.

"Cannot use ##### due to a failure." is displayed

Please contact the service representative.

"Check Document Processor." is displayed

Is the cover of the document processor open?

Close the cover of the document processor.

Is the document processor open?

Close the document processor.

"Check the toner container." is displayed

Open the scanner unit and take out the toner container. Shake the toner container well and set it again.

"Color toner is empty. Cannot print this document." is displayed

Replace with the toner container specified by us.

NOTE

If there is still black toner left even after color toner has run out and "Color Toner Empty Action" is set to [Print in Black & White], black and white printing is possible temporarily.

"Confidential document was detected." is displayed

A confidential document has been detected.

The job is canceled. Select [End].

"Failed to activate." is displayed

Failed to activate the application.

Contact administrator.

Extended authentication is disabled.

Turn the power switch off and then on again. If the error persists, contact administrator.

1 Turn the power switch off.

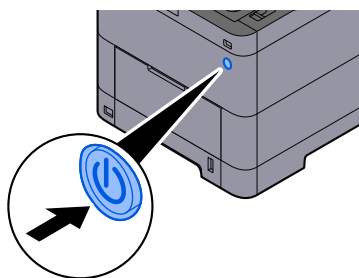

The confirmation message for power supply off is displayed.

It takes approximately 3 minutes for power off.

CAUTION

If this machine will be left unused for an extended period (e.g. overnight), turn it off at the power switch. If the machine will not be used for an even longer period of time (e.g. vacation), remove the power plug from the outlet as a safety precaution.

 **IMPORTANT**

- If using the products equipped with the fax function, note that turning the machine off at the power switch disables fax transmission and reception.
 - Remove paper from the cassettes and seal it in the paper storage bag to protect it from humidity.
-

"Failed to send via SMB." is displayed

Are this machine and the scanned image destination PC connected to the network?

Check the network.

- Connecting LAN Cable
- Hub behavior
- The server status
- Host name or IP address
- Port number

➔ [Connecting LAN Cable \(page 48\)](#)

➔ [Network Setup \(page 79\)](#)

➔ [NetworkSettings \(page 476\)](#)

Is the account information (user ID, password) used to access the shared folder to which the scanned image is to be sent incorrect?

Check the settings of the scanned image destination PC.

- Host Name
- Path
- Login user name

 **NOTE**

If the sender is a domain user, specify the domain name. [Login User name]@[Domain name]

Example) sa720XXXX@km

- Login Password
 - Folder share permissions of the recipient
-

"Failed to specify Job Accounting." is displayed

Failed to specify Job Accounting when processing the job externally.

The job is canceled. Select [End].

NOTE

If Auto Error Clear is set to [On], the process will resume automatically after a set period of time. For details, refer to the following:

➔ [Auto Error Clear \(page 440\)](#)

"Failed to store job retention data." is displayed

The job is canceled. Select [End].

"Subaddress box limit exceeded." is displayed

Follow the on-screen instructions to delete documents in the subaddress box.

For canceled jobs, select the [Status / Job Cancel] key > [Printing Jobs], and check the print job log.

➔ **FAX Operation Guide**

"Incorrect account ID." is displayed

The account ID was incorrect when processing the job externally.

The job is canceled. Select [End].

"Job Accounting restriction exceeded." is displayed

Is the acceptable printing count restricted by Job Accounting exceeded?

The printing count exceeded the acceptable count restricted by Job Accounting. Cannot print any more.

The job is canceled. Select [End].

"KPDL error." is displayed

PostScript error has occurred.

The job is canceled. Select [End].

NOTE

If Auto Error Clear is set to [On], the process will resume automatically after a set period of time. For details, refer to the following:

→ [Auto Error Clear \(page 440\)](#)

"Machine failure." is displayed

Internal error has occurred.

Make a note of the error code displayed on the screen and contact service representative.

"Maximum number of scanned pages." is displayed

Is the acceptable scanning count exceeded?

Cannot scan pages any more. Follow the instructions on the screen.

"Memory is full." is displayed

The memory is full and the job cannot be continued.

Select [Continue] to process a scanned page. The print job cannot be processed completely. Select [Cancel] to cancel the job.

The process cannot be performed due to insufficient memory.

If only [End] is displayed, select [End]. The job is canceled.

When insufficient memory occurred frequently, contact your dealer or service representative.

 **NOTE**

If Auto Error Clear is set to [On], the process will resume automatically after a set period of time. For details, refer to the following:

→ [Auto Error Clear \(page 440\)](#)

"Paper jam." is displayed

A paper jam has occurred.

If a paper jam occurs, the machine will stop and the location of the jam will be indicated on the screen. Leave the machine on and follow the instructions to remove the jammed paper.

→ [Jam Location Indicators \(page 725\)](#)

"Performing Drum Refresh..." is displayed

The machine is in adjustment mode to maintain quality.

Please wait.

"Regulating the temperature..." is displayed

The machine is in adjustment mode to maintain quality.

Please wait.

"Remove originals in Document Processor." is displayed

Are there any originals left in the document processor?

Remove the original from the document processor.

 **CAUTION**

If the paper tears during removal, be sure to remove any loose scraps of paper from inside the machine. Scraps of paper left in the machine could cause subsequent jamming.

1 Remove the originals from the Original Table.

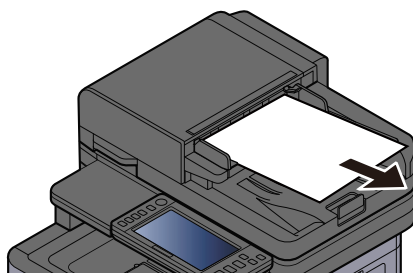

2 Open the Document Processor cover and remove the jammed paper.

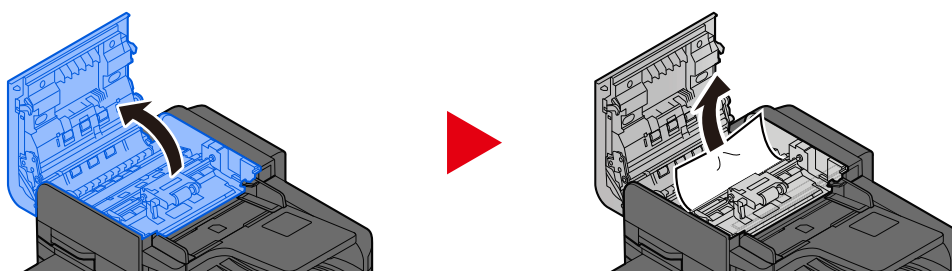

3 Turn dial C to remove the jammed paper.

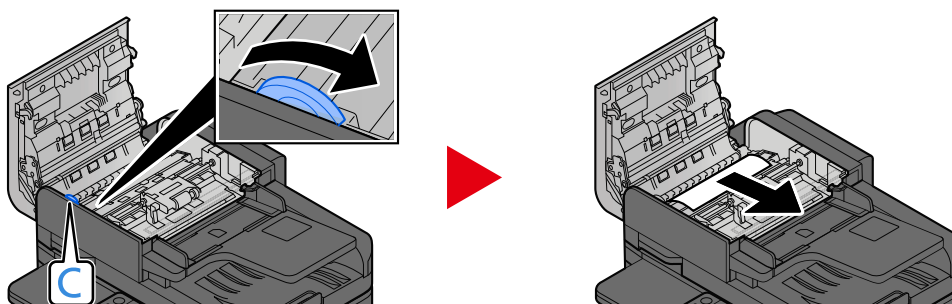

4 Return the cover to the original position.

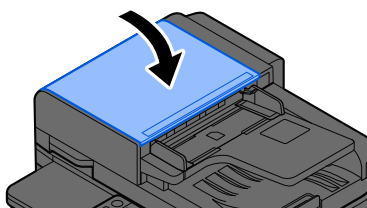

"Running security function..." is displayed

The security function is running.

Please wait.

"Scanner memory is full." is displayed

Scanning cannot be performed due to insufficient memory of the scanner.

Follow the instructions on the screen.

"Scheduled sending jobs exceeded." is displayed

The number of timer transmissions that can be set has been exceeded.

Select [End]. The job is canceled.

Wait until the delayed transmission is executed, or cancel the delayed transmission and then perform the job again.

"Select another cassette." is displayed

Is the selected cassette correct?

The specified cassette is dedicated for the fax machine.

Select another valid cassette and then select [Continue].

"Send error." is displayed

An error has occurred during sending.

The job is canceled. Select [End]. Refer to the transmission error code list for the error code and its details.

➔ [List of Transmission Error Codes \(page 676\)](#)



NOTE

If Auto Error Clear is set to [On], the process will resume automatically after a set period of time. For details, refer to the following:

➔ [Auto Error Clear \(page 440\)](#)

"Skewed originals or multi originals fed at once." is displayed

See the caution attached on the document processor and check the originals. If the originals are jammed, follow the instructions on the screen to remove the originals.

➔ [Remove any jammed paper in the Document Processor \(Reverse Automatic\) \(page 739\)](#)

"SSD error." is displayed

An error has occurred on the SSD.

The job is canceled. Select [End].

The following error code is displayed:

- 01: The amount of data that can be saved at once has been exceeded. Restart the system or turn the power OFF/ON. If the error still occurs, divide the file into smaller files.
If the error still persists, the SSD is damaged. Execute [System Initialization].
- 04: Insufficient space remaining on SSD. Move data or delete unneeded data.

NOTE

Please note that the data stored on the SSD will be deleted when system initialization is performed.

"System error." is displayed

System error has occurred.

Follow the instruction displayed on the screen.

"The device cannot be connected because allowed connections would be exceeded." is displayed

Are you connecting more than the maximum number of Wi-Fi Direct connections?

Disconnect the mobile devices that you are not using, or set the [automatic disconnection] of this unit to disconnect the mobile devices.

➔ [Wi-Fi Direct Settings \(page 477\)](#)

"The password does not meet password policy." is displayed

Has your password expired?

Change the login password. The job is canceled. Select [End].

➔ [Password Policy Settings \(page 523\)](#)

Have your password policy requirements changed (password length, strings of characters to use, etc.)?

Check your password policy requirements and change the login password.

The job is canceled. Select [End].

➔ [Password Policy Settings \(page 523\)](#)

"Malicious program was detected." is displayed

Execution was aborted due to a possible malware program.

The names of applications for which malware has been detected are displayed.

Please contact the administrator.

"RAM disk error." is displayed

A RAM disk error has occurred.

The job is canceled. Select [End].

The following error code is possible:

04: There is not enough free space on the RAM disk. If the optional RAM disk is installed, increase the RAM disk size by using [RAM Disk Setting] in the System Menu.

➔ [Device Security Settings \(page 504\)](#)

NOTE

The volume of RAM disk size can be increased by selecting [Printer Priority] in the [Optional Memory] settings.

➔ [Others \(page 516\)](#)

"Maintenance is needed for imaging units soon." is displayed

For TASKalfa MA4500ci

The maintenance kit needs to be replaced at every 300,000 pages of printing.

For TASKalfa MA3500ci

The maintenance kit needs to be replaced at every 200,000 pages of printing.

"Maintenance is needed for paper cassette soon." is displayed

Contact your service representative.

After replacing the parts, follow the steps below:

- 1 **[System Menu / Counter]key > [Adjustment/Maintenance] > "Others" > [Service Settings] > [Maintenance (Cassette 1)] to [Maintenance (Cassette 5)]**

"Maintenance is needed for Document Processor soon." is displayed

Contact your service representative.

After replacing the parts, follow the steps below:

- 1 **[System Menu / Counter]key > [Adjustment/Maintenance] > "Others" > [Service Settings] > [Maintenance (Cassette 1)] to [Maintenance (Cassette 5)]**

"Maintenance is needed for imaging units." is displayed

For TASKalfa MA4500ci

The maintenance kit needs to be replaced at every 300,000 pages of printing.

For TASKalfa MA3500ci

The maintenance kit needs to be replaced at every 200,000 pages of printing.

"Maintenance is needed for paper cassette." is displayed

Contact your service representative.

After replacing the parts, follow the steps below:

- 1 [System Menu / Counter]key > [Adjustment/Maintenance] > "Others" > [Service Settings] > [Maintenance (Cassette 1)] to [Maintenance (Cassette 5)]

"Maintenance is needed for Multipurpose Tray." is displayed

"Maintenance is needed for Document Processor." is displayed

"The slit glass requires cleaning." is displayed

The slit glass requires cleaning.

When using the document processor, clean the slit glass surface and the reading guide with the dry cloth.

 **IMPORTANT**

Do not use water, soap or solvents for cleaning.

 **NOTE**

Dirt on the slit glass or the reading guide may cause black streaks to appear in the output.

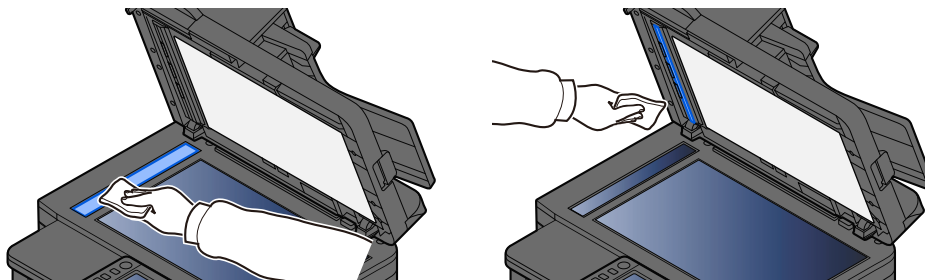

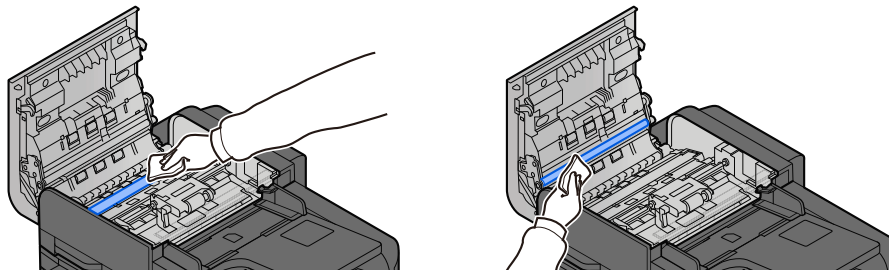

"Toner[C][M][Y][K]is empty." is displayed

Replace the toner container to our specified toner container.

NOTE

If there is still black toner left even after color toner has run out and "Color Toner Empty Action" is set to [Print in Black & White], black and white printing is possible temporarily.

CAUTION

Do not attempt to incinerate parts which contain toner. Dangerous sparks may cause burns.

Installation procedures of the toner container is same for every color. Here, we'll explain the procedures for the yellow toner container, as an example.

1 Open the Scanner Unit

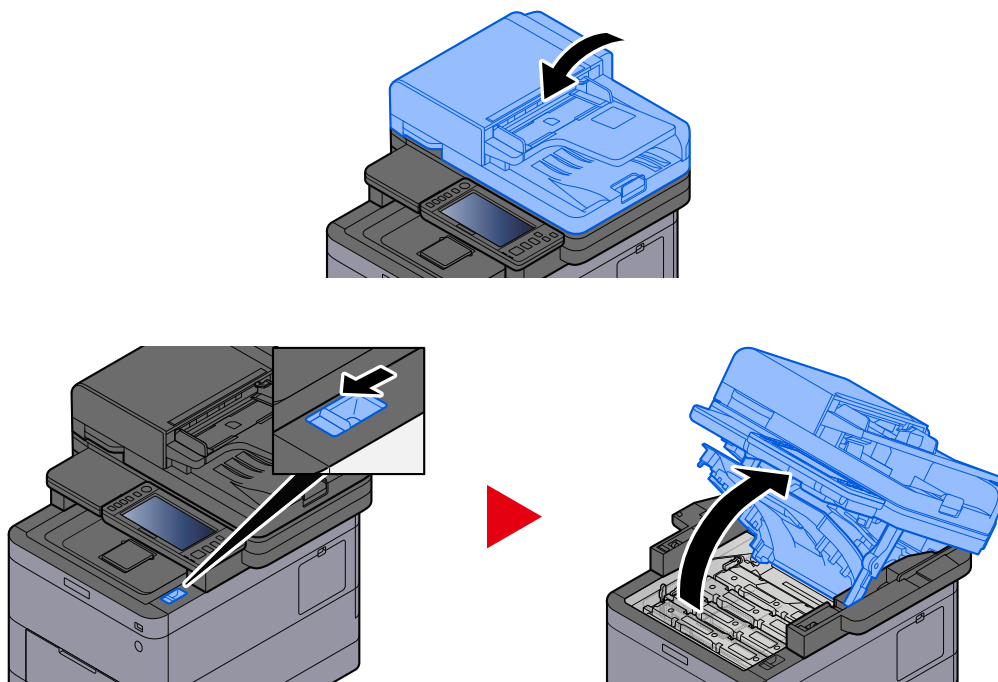

The Toner Container Lock of the empty toner container is unlocked.



NOTE

If the toner container is locked, select [Unlock toner container] and release the toner container lock.

2 Remove the toner container.

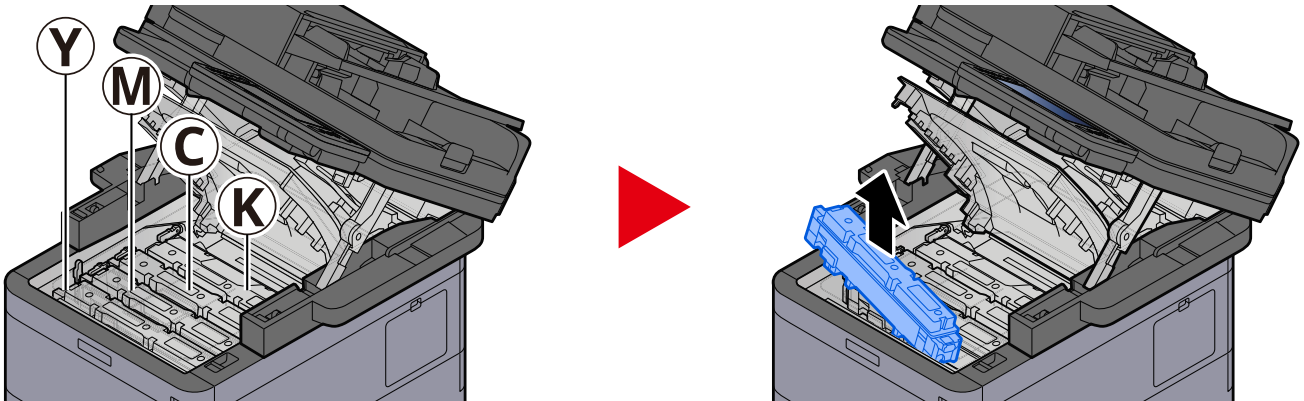

3 Put used toner container into the plastic waste bag.

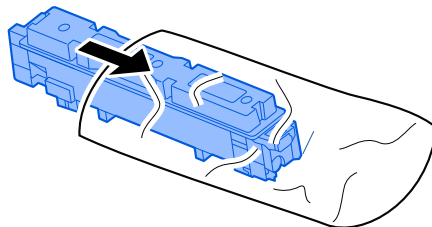

4 Remove the new toner container from the box.

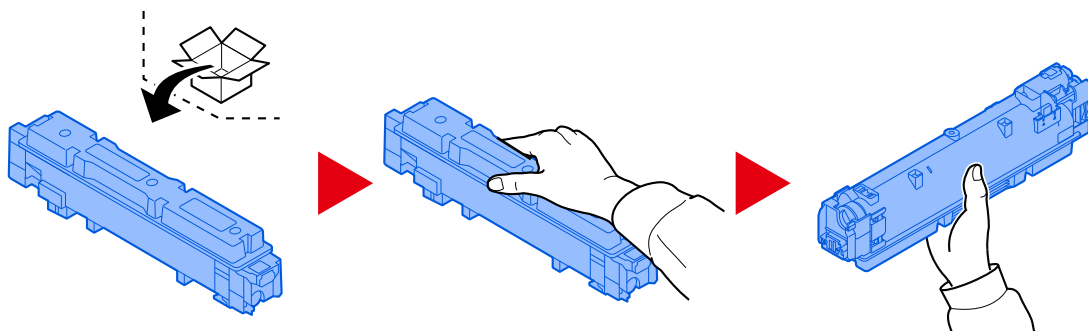

✔ **IMPORTANT**

Do not touch the points shown below.

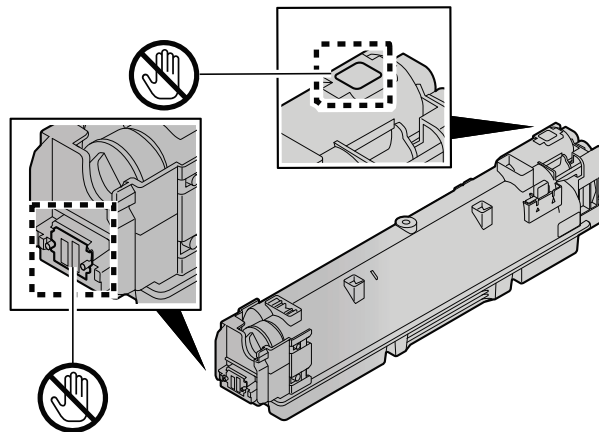

5 Shake the toner container.

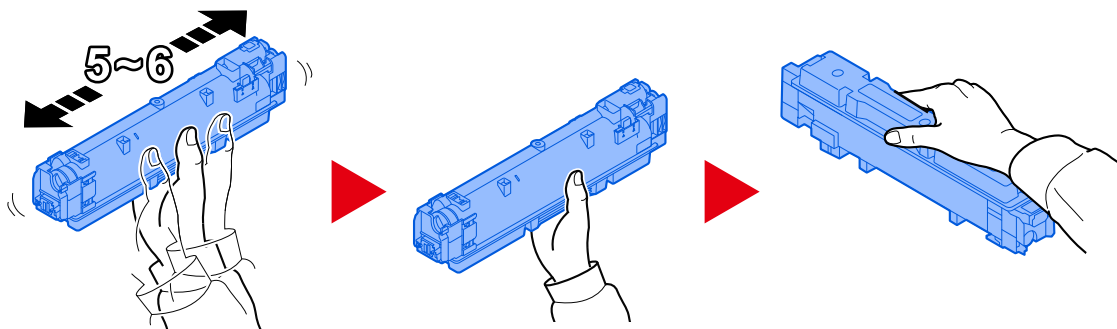

6 Install the toner container.

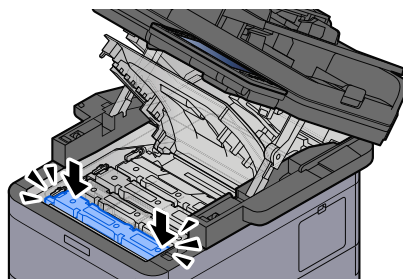

✔ **IMPORTANT**

Insert the toner container all the way.

7 Close the Scanner Unit

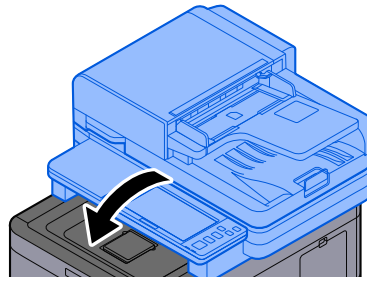

 **NOTE**

- If the Scanner Unit does not close, check that the new toner container is installed correctly.
 - Return the exhausted toner container to your dealer or service representative. The collected toner container will be recycled or disposed in accordance with the relevant regulations.
-

"Toner [C][M][Y][K] is low. (Replace when empty.)" is displayed

It is almost time to replace the toner container.

Obtain a new toner container.

"Toner type mismatch. Please install correct toner." is displayed

Does the type of toner you have match the model?

Please install correct toner.

"USB Drive error." is displayed

Is the USB drive write-protected?

An error occurred in the USB drive. The job is canceled. Select [End].

The following error code is displayed:

01: Connect a writeable USB drive.

An error occurred in the USB drive.

The job is canceled. Select [End].

The following error code is displayed:

01: The amount of data that can be saved at once has been exceeded. Restart the system or turn the power OFF/ON.

If the error persists, the USB drive is not compatible with the machine. Use the USB drive formatted by this machine. If the USB drive cannot be formatted, it is damaged. Connect a compatible USB drive.

 **NOTE**

If Auto Error Clear is set to [On], the process will resume automatically after a set period of time. For details, refer to the following:

→ [Auto Error Clear \(page 440\)](#)

"USB Drive is full." is displayed

There is not enough free space on the USB drive.

The job is canceled. Select [End].

Delete unnecessary files on the USB drive.

 **NOTE**

If Auto Error Clear is set to [On], the process will resume automatically after a set period of time. For details, refer to the following:

→ [Auto Error Clear \(page 440\)](#)

"The USB Drive is not formatted." is displayed

Is the USB drive formatted by this machine?

Execute [Format] of the USB drive on this machine.

1 Display the screen.

1 Select the [Home] key.

2 Select [DeviceInformation].

The screen to check the status or configure the devices is displayed.

2 Select [Format] of "USB Drive"

 **IMPORTANT**

When [Format] is selected, all data in the USB drive is erased.

"Warning for high temp. Adjust the room temp." is displayed

Print quality may be deteriorated. Adjust the temperature and the humidity of your room.

"Warning for low temp. Adjust the room temp." is displayed

Print quality may be deteriorated. Adjust the temperature and the humidity of your room.

"Warning low memory." is displayed

Cannot start the job. Try again later.

"Waste Toner Box is full." is displayed

Is the waste toner box full?

The waste toner box needs to be replaced.



CAUTION

Do not attempt to incinerate parts which contain toner. Dangerous sparks may cause burns.

1 Open the Waste Toner Cover

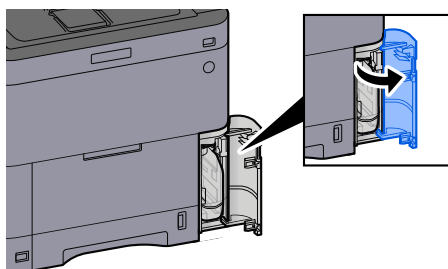

2 Remove the Waste Toner Box.

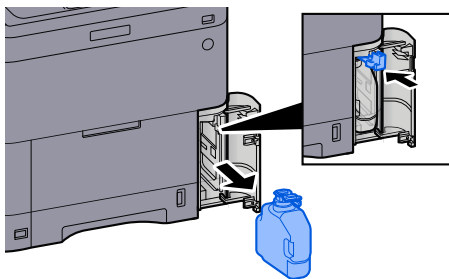

3 Put used Waste Toner Box into the plastic waste bag.

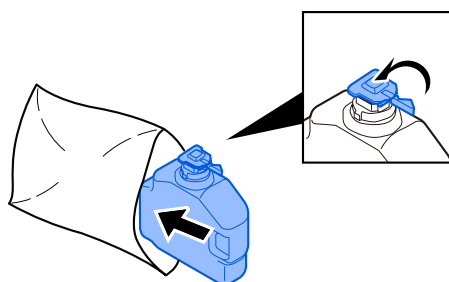

4 Remove the new Waste Toner Box.

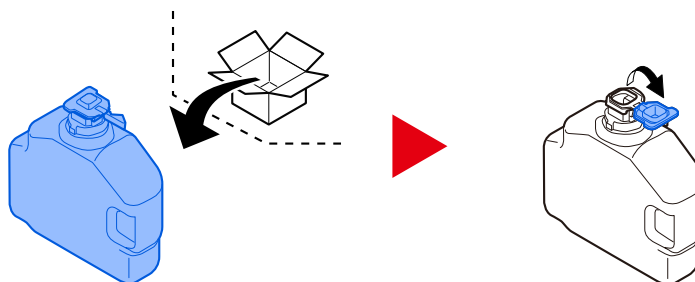

5 Install the Waste Toner Box.

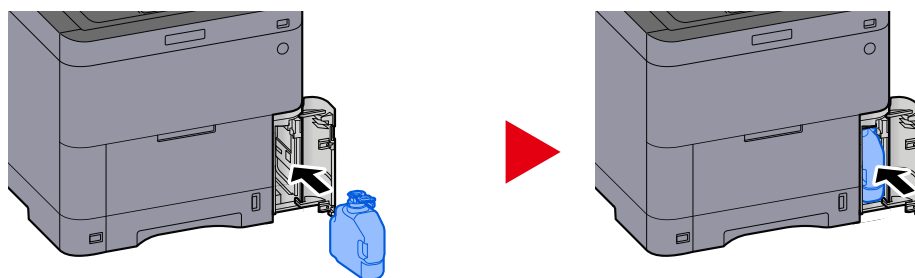

6 Close the Waste Toner Cover

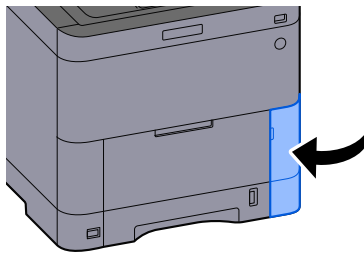

NOTE

Return the exhausted waste toner box to your dealer or service representative. The collected waste toner box will be recycled or disposed in accordance with the relevant regulations.

"You cannot use this box." is displayed

You do not have permission to use the specified box.

The job is canceled. Select [End].

List of Transmission Error Codes

1101 "Failed to send the email." is displayed

Message

Failed to send the email.

Check the host name of the SMTP server on the Command Center RX

Job is canceled. Press [End].

1101

Corrective Actions

Enter the host name of the SMTP server in Command Center RX.

- 1 Launch your Web browser.**
- 2 In the address or location bar, enter the machine's IP address or the host name.**
- 3 Log in with administrator privileges.**
- 4 Click [E-mail] of the [Functions] Menu.**
- 5 Check the [SMTP Server Name] in "SMTP".**
Correct anything that is incorrect.
- 6 Click [Submit].**
→ [SMTP and E-mail Settings \(page 125\)](#)

1101 "Failed to send via SMB." is displayed

Message

Failed to send via SMB.

Check the SMB settings.

> Login user name and login password

Note:

If the sender is a domain user, specify the domain name.

> Host name

> Path

Job is canceled. Press [End].

1101

Corrective Actions

Check the host name of the destination computer.

1 When entering the destination information, make sure that the host name or IP address of the destination computer is correct.

➔ [Sending Document to Desired Shared Folder on a Computer \(Scan to PC\) \(page 250\)](#)



NOTE

If you are a domain user, specify the domain name.

To specify a destination registered in the address book, proceed to the next step.

2 Check the Address Book

1 [System Menu / Counter] key > [FunctionSettings] > [Address Book] > [Add/Edit Machine Address Book]

2 Select the information icon for the destination.

3 Make sure that the host name or IP address of the destination computer is correct.



NOTE

If you are a domain user, specify the domain name.

If it is incorrect, correct it.

4 [Register] > [OK]

Register the changed destination.

➔ [Editing Contact Address in Address Book \(page 182\)](#)

1101 "Failed to send via FTP." is displayed

Message

Failed to send via FTP.

Check the host name or IP address of FTP.

Job is canceled. Press [End].

1101

Corrective Actions

Check the host name of the FTP.

1 When entering the destination information, make sure that the host name or IP address of the FTP server is correct.

➔ [Sending Document to Folder on an FTP Server \(Scan to FTP\) \(page 253\)](#)

To specify a destination registered in the address book, proceed to the next step.

2 Check the Address Book

1 [System Menu / Counter] key > [FunctionSettings] > [Address Book] > [Add/Edit Machine Address Book]

2 Select the information icon for the destination.

3 Make sure that the host name or IP address of the FTP server is correct.

If it is incorrect, correct it.

4 [Register] > [OK]

Register the changed destination.

➔ [Editing Contact Address in Address Book \(page 182\)](#)

1102 "Failed to send the email." is displayed

Message

Failed to send the email.

Check the followings on the Command Center RX

- > SMTP login user name and login password
- > POP3 login user name and login password

1102

Corrective Actions

Check the login user name and password for the SMTP server and POP3 server.

- 1 Launch your Web browser.**
- 2 In the address or location bar, enter the machine's IP address or the host name.**
- 3 Log in with administrator privileges.**
- 4 Click [E-mail] in the [Functions]**
- 5 Check whether the login user name and password for the SMTP server have been entered in [Authentication Protocol] of "SMTP", and change the settings as necessary.**
- 6 Click [Settings] in "POP3 User Settings"**
- 7 Check whether the login user name and password have been entered and change the settings as necessary.**
- 8 Click [Submit].**
 - ➔ [SMTP and E-mail Settings \(page 125\)](#)

1102 "Failed to send via SMB." is displayed

Message

Failed to send via SMB.

Check the SMB settings.

> Login user name and login password

Note:

If the sender is a domain user, specify the domain name.

> Host name

> Path

Job is canceled. Press [End].

1102

Corrective Actions

Check the login user name and password of the destination computer.

1 When entering the destination information, make sure that the login user name and password of the destination computer is correct.

➔ [Sending Document to Desired Shared Folder on a Computer \(Scan to PC\) \(page 250\)](#)



NOTE

- If the computer name and domain name are different, check that they are entered as follows.
Domain name\User name
- If you use a host name, make sure it does not contain the following forbidden characters:
~ ! @ # \$ % ^ & * () = + [] { } \ | ; : ' " < > / ?

To specify a destination registered in the address book, proceed to the next step.

2 Check the Address Book

- 1 [System Menu / Counter] key > [FunctionSettings] > [Address Book] > [Add/Edit Machine Address Book]
- 2 Select the information icon for the destination.
- 3 Make sure that the login user name and password of the destination computer are correct.
If it is incorrect, correct it.



NOTE

- If the computer name and domain name are different, check that they are entered as follows.
Domain name\User name
- If you use a host name, make sure it does not contain the following forbidden characters:
~ ! @ # \$ % ^ & * () = + [] { } \ | ; : ' " < > / ?

- 4 [Register] > [OK]
Register the changed destination.

➔ [Editing Contact Address in Address Book \(page 182\)](#)

1102 "Failed to send via FTP." is displayed

Message

Failed to send via FTP.

Check the FTP settings.

> Login user name and login password

Note:

If the sender is a domain user, specify the domain name.

Job is canceled. Press [End].

1102

Corrective Actions

Check the login user name and password for the FTP.

1 When entering the destination information, make sure that the login user name and password of the FTP server is correct.

➔ [Sending Document to Folder on an FTP Server \(Scan to FTP\) \(page 253\)](#)



NOTE

- If you are a domain user, specify the domain name.
 - If the computer name and domain name are different, check that they are entered as follows.
Domain name\User name
-

To specify a destination registered in the address book, proceed to the next step.

2 Check the Address Book

- 1 [Home] key > [...] > [System Menu] > [FunctionSettings] > [Address Book] > [Add/Edit Machine Address Book]
 - 2 Select the information icon for the destination.
 - 3 Make sure that the login user name and password of the FTP are correct.
-



NOTE

- If you are a domain user, specify the domain name.
 - If the computer name and domain name are different, check that they are entered as follows.
Domain name\User name
-

If it is incorrect, correct it.

- 4 [Register] > [OK]

Register the changed destination.

➔ [Editing Contact Address in Address Book \(page 182\)](#)

1103 "Failed to send via SMB." is displayed

Message

Failed to send via SMB.

Check the SMB settings.

> Login user name and login password

Note:

If the sender is a domain user, specify the domain name.

> Path

> Folder share permissions of the recipient

Job is canceled. Press [End].

1103

Corrective Actions

Check the login user name and password of the destination computer, and the destination folder path.

1 When entering the destination information, make sure that the login user name and password of the destination computer, and the destination folder path are correct.

→ [Sending Document to Desired Shared Folder on a Computer \(Scan to PC\) \(page 250\)](#)



NOTE

If the computer name and domain name are different, check that they are entered as follows.

Domain name\User name

To specify a destination registered in the address book, proceed to the next step.

2 Check the Address Book

1 [System Menu / Counter] key > [FunctionSettings] > [Address Book] > [Add/Edit Machine Address Book]

2 Select the information icon for the destination.

3 Make sure that the login user name and password of the destination computer are correct.

If it is incorrect, correct it.



NOTE

If the computer name and domain name are different, check that they are entered as follows.

Domain name\User name

4 [Register] > [OK]

Register the changed destination.

→ [Editing Contact Address in Address Book \(page 182\)](#)

3 Make sure the folder sharing settings are configured correctly

Check the sharing settings and permissions in the folder properties.

1 Right-click the shared folder and click [Properties] → [Security] tab.

- 2 Select a user and make sure the user you entered in the group name or user name field is displayed
- 3 Make sure that [Allow] is checked off for "Modify" and "Read & Execute"
- 4 Click the [Close] button.
 - ➔ [Creating a Shared Folder, Making a Note of a Shared Folder \(page 158\)](#)

1103 "Failed to send via FTP." is displayed

Message

Failed to send via FTP.
Check the FTP settings.
> Login user name and login password

1103

Corrective Actions

Check the destination folder path.

1 When entering the destination information, make sure that the login user name and password of the destination computer, and the destination folder path are correct.

➔ [Sending Document to Folder on an FTP Server \(Scan to FTP\) \(page 253\)](#)



NOTE

If no path is entered, the file is stored in the home directory.

To specify a destination registered in the address book, proceed to the next step.

2 Check the Address Book

- 1 [System Menu / Counter] key > [FunctionSettings] > [Address Book] > [Add/Edit Machine Address Book]
 - 2 Select the information icon for the destination.
 - 3 Make sure that the destination folder path is correct.
-



NOTE

If no path is entered, the file is stored in the home directory.

If it is incorrect, correct it.

- 4 [Register] > [OK]
Register the changed destination.

➔ [Editing Contact Address in Address Book \(page 182\)](#)

1104 "Failed to send the email." is displayed

Message

Failed to send the email.

Check the email address.

Note:

If the address is rejected by the domain, you cannot send the email.
Job is canceled. Press [End].

1104

Corrective Actions

Check the Email Address.

1 When entering the destination information, make sure that the email address is correct.

➔ [Sending Document via E-mail \(page 248\)](#)

To specify a destination registered in the address book, proceed to the next step.

2 Check the Address Book

1 [System Menu / Counter] key > [FunctionSettings] > [Address Book] > [Add/Edit Machine Address Book]

2 Select the information icon for the destination.

3 Check the Email Address

If it is incorrect, correct it.

4 [Register] > [OK]

Register the changed destination.

➔ [Editing Contact Address in Address Book \(page 182\)](#)

If the problem persists, proceed to the next step.

3 Make sure your email address is not rejected due to domain restrictions

1 Launch a web browser.

2 In the address or location bar, enter the machine's IP address or the host name.

3 Log in with administrator privileges.

4 Click [E-mail] in the [Functions]

5 Click [Domain List] in "SMTP"

The SMTP domain restriction list is displayed.

6 If the email address you use is included in the list, delete it.

7 Click [Submit] twice.

➔ [SMTP and E-mail Settings \(page 125\)](#)

1105 "Failed to send the email." is displayed

Message

Failed to send the email.

Select [On] of the SMTP settings on the Command Center RX

Job is canceled. Press [End].

1105

Corrective Actions

From Command Center RX, check that SMTP (email sending) is On.

- 1 Launch your Web browser.**
- 2 In the address or location bar, enter the machine's IP address or the host name.**
- 3 Log in with administrator privileges.**
- 4 Click [Protocols] of the [Network Settings] Menu.**
- 5 Set "SMTP (E-mail TX)" in "Send Protocol" to [On]**
- 6 Click [Submit].**
 - ➔ [SMTP and E-mail Settings \(page 125\)](#)

1105 "Failed to send via SMB." is displayed

Message

Failed to send via SMB.

Select [On] of the SMB settings on the Command Center RX

Job is canceled. Press [End].

1105

Corrective Actions

Make sure the protocol is set correctly.

- 1** Launch your Web browser.
- 2** In the address or location bar, enter the machine's IP address or the host name.
- 3** Log in with administrator privileges.
- 4** Click [Protocols] in the [Network Settings]
- 5** Set "SMB" in "Send Protocol" to [On]
- 6** Click [Submit].
 - ➔ [SMTP and E-mail Settings \(page 125\)](#)

1105 "Failed to send via FTP." is displayed

Message

Failed to send via FTP.

Select [On] of the FTP settings on the Command Center RX

Job is canceled. Press [End].

1105

Corrective Actions

Make sure the protocol is set correctly.

- 1** Launch your Web browser.
- 2** In the address or location bar, enter the machine's IP address or the host name.
- 3** Log in with administrator privileges.
- 4** Click [Protocols] in the [Network Settings]
- 5** Set "FTP Client (Transmission)" in "Send Protocol" to [On]
- 6** Click [Submit].
 - ➔ [SMTP and E-mail Settings \(page 125\)](#)

1106 "Failed to send the email." is displayed

Message

Failed to send the email.

Check the sender address of SMTP on the Command Center RX

Job is canceled. Press [End].

1106

Corrective Actions

Check the sender address on the SMTP server from Command Center RX.

- 1 Launch your Web browser.**
- 2 In the address or location bar, enter the machine's IP address or the host name.**
- 3 Log in with administrator privileges.**
- 4 Click [E-mail] of the [Functions] Menu.**
- 5 Set the [Sender Address] in "E-mail Send Settings".**

Please specify an email address that can be received by the Machine Administrator. The sender address must be entered correctly for SMTP authentication. The maximum length of the sender address is 256 characters.

- 6 Click [Submit].**

➔ [SMTP and E-mail Settings \(page 125\)](#)

1131 "Failed to send via FTP." is displayed

Message

Failed to send via FTP.

Select [On] of the secure protocol settings on the Command Center RX

Job is canceled. Press [End].

1131

Corrective Actions

Please set to allow the use of TLS.

- 1** Launch your Web browser.
- 2** In the address or location bar, enter the machine's IP address or the host name.
- 3** Log in with administrator privileges.
- 4** Click [Network Security] in the [Security Settings]
- 5** Set [TLS] to [On]
- 6** Click [Submit].

➔ [Command Center RX User Guide](#)

1132 "Failed to send via FTP." is displayed

Message

Failed to send via FTP.

Check the followings of the FTP server.

- > FTPS is available.
- > Encryption is available.

Job is canceled. Press [End].

1132

Corrective Actions

Check the destination server.

- 1 Make sure the destination server supports FTPS (File Transfer Protocol over TLS)**
If the problem persists, proceed to the next step.
- 2 Make sure the destination server supports the encryption method you have set.**

2101 "Failed to send the email." is displayed

Message

Failed to send the email.
Check the network and Command Center RX
> The network cable is connected.
> The hub is not operating properly.
> The server is not operating properly.
> POP3 server name of the POP3 user
> SMTP server name
Job is canceled. Press [End].

2101

Corrective Actions

Check Command Center RX and network settings.

1 Connect the network cable

Check that the LAN cable is properly connected.
If there is no improvement, proceed to the next step.

2 Check the operation of the hub.

Check that the hub access lamp is illuminated or flashing.
If there is no improvement, proceed to the next step.

3 Check the status of the server.

Check that the server is up and responding with ping.
If there is no improvement, proceed to the next step.

4 Check the host name of the SMTP server in Command Center RX.

- 1 Launch a web browser.
- 2 In the address or location bar, enter the machine's IP address or the host name.
- 3 Log in with administrator privileges.
- 4 Click [E-mail] in the [Functions]
- 5 Check "SMTP" [SMTP Server Name]
Correct anything that is incorrect.
- 6 Click [Submit].
If the problem persists, proceed to the next step.

5 Check the users in POP before SMTP authentication in Command Center RX.

Set this when using POP before SMTP as SMTP authentication.

- 1 Launch a web browser.
- 2 In the address or location bar, enter the machine's IP address or the host name.
- 3 Log in with administrator privileges.

- 4 Click [E-mail] in the [Functions]
- 5 Select "Authentication Protocol" [POP before SMTP]
- 6 Check that [Other] is not selected from "Authenticate as"
If this is not the case, select a valid POP3 user other than [Other].
- 7 Click [Submit] twice.
If the problem persists, proceed to the next step.

6 Check the POP3 server name for POP3 users in Command Center RX

- 1 Launch a web browser.
- 2 In the address or location bar, enter the machine's IP address or the host name.
- 3 Log in with administrator privileges.
- 4 Click [E-mail] in the [Functions]
- 5 Click "POP3 User Settings" [Settings]
The "POP3 User Settings" screen is displayed.
- 6 Check the [POP3 Server Name] of "user 1 (to 3)".
Correct anything that is incorrect.
- 7 Click [Submit] twice.

2101 "Failed to send via SMB." is displayed

Message

Failed to send via SMB.

Check the network and SMB settings.

- > The network cable is connected.
- > The hub is not operating properly.
- > The server is not operating properly.
- > Host name and IP address
- > Port number

Job is canceled. Press [End].

2101

Corrective Actions

Check your network and SMB settings.

1 Connect the network cable

Check that the LAN cable is properly connected.

If there is no improvement, proceed to the next step.

2 Check the operation of the hub.

Check that the hub access lamp is illuminated or flashing.

If there is no improvement, proceed to the next step.

3 Check the status of the server.

Check that the server is up and responding with ping.

If there is no improvement, proceed to the next step.

4 When entering the destination information, make sure that the host name or IP address of the destination computer and the port number are correct.

➔ [Sending Document to Desired Shared Folder on a Computer \(Scan to PC\) \(page 250\)](#)

To specify a destination registered in the address book, proceed to the next step.

5 Check the Address Book

1 [System Menu / Counter] key > [FunctionSettings] > [Address Book] > [Add/Edit Machine Address Book]

2 Select the information icon for the destination.

3 Make sure that the host name or IP address of the destination computer and the port number are correct.

If it is incorrect, correct it.

4 [Register] > [OK]

Register the changed destination.

➔ [Editing Contact Address in Address Book \(page 182\)](#)

2101 "Failed to send via FTP." is displayed

Message

Failed to send via FTP.

Check the network and FTP settings.

- > The network cable is connected.
- > The hub is not operating properly.
- > The server is not operating properly.
- > Host name and IP address
- > Port number

Job is canceled. Press [End].

2101

Corrective Actions

Check your network and FTP settings.

1 Connect the network cable

Check that the LAN cable is properly connected.

If there is no improvement, proceed to the next step.

2 Check the operation of the hub.

Check that the hub access lamp is illuminated or flashing.

If there is no improvement, proceed to the next step.

3 Check the status of the server.

Check that the server is up and responding with ping.

If there is no improvement, proceed to the next step.

4 When entering the destination information, make sure that the host name or IP address of the destination computer and the port number are correct.

➔ [Sending Document to Folder on an FTP Server \(Scan to FTP\) \(page 253\)](#)

To specify a destination registered in the address book, proceed to the next step.

5 Check the Address Book

1 [System Menu / Counter] key > [FunctionSettings] > [Address Book] > [Add/Edit Machine Address Book]

2 Select the information icon for the destination.

3 Make sure that the host name or IP address of the destination computer and the port number are correct.

If it is incorrect, correct it.

4 [Register] > [OK]

Register the changed destination.

➔ [Editing Contact Address in Address Book \(page 182\)](#)

2102 "Failed to send the email." is displayed

Message

Failed to send the email.

Check the network.

- > The network cable is connected.
- > The hub is not operating properly.
- > The server is not operating properly.

Job is canceled. Press [End].

2102

Corrective Actions

Check your network and destination server settings.

1 Connect the network cable

Check that the LAN cable is properly connected.

If there is no improvement, proceed to the next step.

2 Check the operation of the hub.

Check that the hub access lamp is illuminated or flashing.

If there is no improvement, proceed to the next step.

3 Check the server status.

Make sure the server is running and responds to pings.

2102 "Failed to send via FTP." is displayed

Message

Failed to send via FTP.

Check the followings of the FTP server.

> FTP is available.

> The server is not operating properly.

Job is canceled. Press [End].

2102

Corrective Actions

Check your network and destination server settings.

1 Connect the network cable

Check that the LAN cable is properly connected.

If there is no improvement, proceed to the next step.

2 Check the operation of the hub.

Check that the hub access lamp is illuminated or flashing.

If there is no improvement, proceed to the next step.

3 Check the status of the server.

Check that the server is up and responding with ping.

If there is no improvement, proceed to the next step.

4 Make sure the destination server supports FTPS (File Transfer Protocol over TLS)

2103 "Failed to send the email." is displayed

Message

Failed to send the email.

Check the network.

- > The network cable is connected.
- > The hub is not operating properly.
- > The server is not operating properly.

Job is canceled. Press [End].

2103

Corrective Actions

Check your network settings.

1 Connect the network cable

Check that the LAN cable is properly connected.

If there is no improvement, proceed to the next step.

2 Check the operation of the hub.

Check that the hub access lamp is illuminated or flashing.

If there is no improvement, proceed to the next step.

3 Check the server status.

Make sure the server is running and responds to pings.

2103 "Failed to send via FTP." is displayed

Message

Failed to send via FTP.

Check the network.

- > The network cable is connected.
- > The hub is not operating properly.
- > The server is not operating properly.

Job is canceled. Press [End].

2103

Corrective Actions

Check your network and destination server settings.

1 Connect the network cable

Check that the LAN cable is properly connected.

If there is no improvement, proceed to the next step.

2 Check the operation of the hub.

Check that the hub access lamp is illuminated or flashing.

If there is no improvement, proceed to the next step.

3 Check the status of the server.

Check that the server is up and responding with ping.

If there is no improvement, proceed to the next step.

4 Make sure the destination server supports FTPS (File Transfer Protocol over TLS)

2201 "Failed to send the email." is displayed

Message

Failed to send the email.

Check the network.

- > The network cable is connected.
- > The hub is not operating properly.
- > The server is not operating properly.

Job is canceled. Press [End].

2201

Corrective Actions

Check the network.

1 **Connect the network cable**

Check that the LAN cable is properly connected.

If there is no improvement, proceed to the next step.

2 **Check the operation of the hub.**

Check that the hub access lamp is illuminated or flashing.

If there is no improvement, proceed to the next step.

3 **Check the server status.**

Make sure the server is running and responds to pings.

2201 "Failed to send via SMB." is displayed

Message

Failed to send via SMB.

Check the network.

- > The network cable is connected.
- > The hub is not operating properly.
- > The server is not operating properly.

Job is canceled. Press [End].

2201

Corrective Actions

Check the network.

1 Connect the network cable

Check that the LAN cable is properly connected.

If there is no improvement, proceed to the next step.

2 Check the operation of the hub.

Check that the hub access lamp is illuminated or flashing.

If there is no improvement, proceed to the next step.

3 Check the server status.

Make sure the server is running and responds to pings.

2201 "Failed to send via FTP." is displayed

Message

Failed to send via FTP.

Check the network.

- > The network cable is connected.
- > The hub is not operating properly.
- > The server is not operating properly.

Job is canceled. Press [End].

2201

Corrective Actions

Check the network.

1 Connect the network cable

Check that the LAN cable is properly connected.

If there is no improvement, proceed to the next step.

2 Check the operation of the hub.

Check that the hub access lamp is illuminated or flashing.

If there is no improvement, proceed to the next step.

3 Check the server status.

Make sure the server is running and responds to pings.

2202 "Failed to send the email." is displayed

Message

Failed to send the email.

Check the network.

- > The network cable is connected.
- > The hub is not operating properly.
- > The server is not operating properly.

Job is canceled. Press [End].

2202

Corrective Actions

Check the network.

1 Connect the network cable

Check that the LAN cable is properly connected.

If there is no improvement, proceed to the next step.

2 Check the operation of the hub.

Check that the hub access lamp is illuminated or flashing.

If there is no improvement, proceed to the next step.

3 Check the server status.

Make sure the server is running and responds to pings.

2202 "Failed to send via FTP." is displayed

Message

Failed to send via FTP.

Check the network.

- > The network cable is connected.
- > The hub is not operating properly.
- > The server is not operating properly.

Job is canceled. Press [End].

2202

Corrective Actions

Check the network.

1 Connect the network cable

Check that the LAN cable is properly connected.

If there is no improvement, proceed to the next step.

2 Check the operation of the hub.

Check that the hub access lamp is illuminated or flashing.

If there is no improvement, proceed to the next step.

3 Check the server status.

Make sure the server is running and responds to pings.

2203 "Failed to send via SMB." is displayed

Message

Failed to send via SMB.

Check the network.

- > The network cable is connected.
- > The hub is not operating properly.
- > The server is not operating properly.

Job is canceled. Press [End].

2203

Corrective Actions

Check your network settings.

1 Connect the network cable

Check that the LAN cable is properly connected.

If there is no improvement, proceed to the next step.

2 Check the operation of the hub.

Check that the hub access lamp is illuminated or flashing.

If there is no improvement, proceed to the next step.

3 Check the server status.

Make sure the server is running and responds to pings.

2203 "Failed to send via FTP." is displayed

Message

Failed to send via FTP.

Check the network.

- > The network cable is connected.
- > The hub is not operating properly.
- > The server is not operating properly.

Job is canceled. Press [End].

2203

Corrective Actions

Check the network.

1 **Connect the network cable**

Check that the LAN cable is properly connected.

If there is no improvement, proceed to the next step.

2 **Check the operation of the hub.**

Check that the hub access lamp is illuminated or flashing.

If there is no improvement, proceed to the next step.

3 **Check the server status.**

Make sure the server is running and responds to pings.

2204 "Failed to send the email." is displayed

Message

Failed to send the email.

Check the email size limit of the SMTP settings on the Command Center RX

Job is canceled. Press [End].

2204

Corrective Actions

Check the size restrictions for email sending in the SMTP settings in Command Center RX.

- 1 Launch your Web browser.**
- 2 In the address or location bar, enter the machine's IP address or the host name.**
- 3 Log in with administrator privileges.**
- 4 Click [E-mail] of the [Functions] Menu.**
- 5 Check whether a restriction value is entered in [E-mail Size Limit] of "E-mail Send Settings", and change it as necessary.**
- 6 Click [Submit].**
 - ➔ [SMTP and E-mail Settings \(page 125\)](#)

2231 "Failed to send via FTP." is displayed

Message

Failed to send via FTP.

Check the network.

- > The network cable is connected.
- > The hub is not operating properly.
- > The server is not operating properly.

Job is canceled. Press [End].

2231

Corrective Actions

Check your network settings.

1 Connect the network cable

Check that the LAN cable is properly connected.

If there is no improvement, proceed to the next step.

2 Check the operation of the hub.

Check that the hub access lamp is illuminated or flashing.

If there is no improvement, proceed to the next step.

3 Check the server status.

Make sure the server is running and responds to pings.

3101 "Failed to send the email." is displayed

Message

Failed to send the email.

Check the authentication methods of both the sender and the recipient.

Job is canceled. Press [End].

3101

Corrective Actions

Check the source and destination authentication methods.

1 Check the source and destination authentication methods.

Make sure that the settings for using or not using SMTP/POP authentication of the source matches those of the destination.

3101 "Failed to send via FTP." is displayed

Message

Failed to send via FTP.

Check the network.

- > The network cable is connected.
- > The hub is not operating properly.
- > The server is not operating properly.

Job is canceled. Press [End].

3101

Corrective Actions

Check your network settings.

1 Connect the network cable

Check that the LAN cable is properly connected.

If there is no improvement, proceed to the next step.

2 Check the operation of the hub.

Check that the hub access lamp is illuminated or flashing.

If there is no improvement, proceed to the next step.

3 Check the server status.

Make sure the server is running and responds to pings.

3201 "Failed to send the email." is displayed

Message

Failed to send the email.

Check the SMTP user authentication method of the recipient.

Job is canceled. Press [End].

3201

Corrective Actions

- 1 Check the destination SMTP user authentication method

4801 "Job is canceled. Press [End]." is displayed

Message

Job is canceled. Press [End].

Corrective Actions

Turn the power switch off and then on again. If it occurs repeatedly, write down the error code displayed on the touch panel and contact the service representative.

4802 "Failed to send the email." is displayed

Message

Failed to send the email.

Check the encryption certificate of each destination by the Command Center RX.

Job is canceled. Press [End].

4802

Corrective Actions

Turn the power switch off and then on again. If it occurs repeatedly, write down the error code displayed on the touch panel and contact the service representative.

4803 "Job is canceled. Press [End]." is displayed

Message

Job is canceled. Press [End].

Corrective Actions

Server authentication has expired. Check your network and SMTP settings.

1 Check the date and time of this machine

1 [System Menu / Counter] key > [DeviceSettings] > [Date/Time]

2 Set year, month, day and seconds

If the problem persists, proceed to the next step.

2 Make sure the server is using the correct certificate

If the server certificate has expired, please renew it.

4804 "Job is canceled. Press [End]." is displayed

Message

Job is canceled. Press [End].

Corrective Actions

When communicating with the mail server using SMTP over TLS, communication cannot be started because the signature algorithm of the server certificate does not match the signature algorithm set on the machine.

Please access from Command Center RX to [Security Settings] > [Network Security]. Then, check the value of [Hash] of "Serverside Settings" and [Hash] of [Clientside Settings] and match it with the value on the server side.

Restart the machine after setting.

➔ [Command Center RX User Guide](#)

The error code 4901 is displayed

An error occurred while validating the server certificate.

Corrective Actions

Check the SMTP server certificate.

The error code 4902 is displayed

Your certificate has expired.

Corrective Actions

Check the SMTP server certificate.

The error code 4903 is displayed

An error occurred while validating the X509 certificate.

Corrective Actions

Check the X509 certificate.

The error code 4904 is displayed

The certificate has been revoked.

Corrective Actions

Check the SMTP server certificate.

The error code 4905 is displayed

An error occurred while setting the encryption / signing certificate.

Corrective Actions

Check the settings related to the certificate and the imported certificate.

➔ [Command Center RX User Guide](#)

The error code 4906 is displayed

Certificate verification did not complete within the set time.

Corrective Actions

- Check the verification environment of the OCSP/CRL certificate and other certificates
- Extend the timeout deadline
- Change the certificate verification level

➔ [Command Center RX User Guide](#)

The error code 4a02 is displayed

Failed to initialize S/MIME.

Corrective Actions

Turn the power switch off and then on again. If it occurs repeatedly, write down the error code displayed on the touch panel, check the operation description and then contact the service representative.

The error code 4a03 is displayed

Failed to specify S/MIME encryption.

Corrective Actions

Turn the power switch off and then on again. If it occurs repeatedly, write down the error code displayed on the touch panel, check the operation description and then contact the service representative.

The error code 4a04 is displayed

Failed to scan the S/MIME encryption certificate.

Corrective Actions

- Check and correct the settings related to the S/MIME certificate.
- Turn the power switch off and then on again. If it occurs repeatedly, write down the error code displayed on the touch panel, check the operation description and then contact the service representative.

➔ [Command Center RX User Guide](#)

The error code 4a06 is displayed

Failed to specify job accounting S/MIME Signature.

Corrective Action

Turn the power switch off and then on again. If it occurs repeatedly, write down the error code displayed on the touch panel, check the operation description and then contact the service representative.

The error code 4a07 is displayed

Failed to scan the S/MIME signature certificate.

Corrective Actions

- Check and correct the settings related to the S/MIME signature certificate.
- Turn the power switch off and then on again. If it occurs repeatedly, write down the error code displayed on the touch panel, check the operation description and then contact the service representative.

➔ **Command Center RX User Guide**

The error code 4a08 is displayed

The sender's email address and the email address on the signature certificate do not match.

Corrective Actions

Check the sender's email address and the email address on the signature certificate, and correct the email address(es).

Other error code "Job is canceled. Press [End]." is displayed

Message

Job is canceled. Press [End].

Corrective Actions

Press [End] and restart the machine.

1 Turn the power switch off and then on again

If it occurs repeatedly, write down the error code displayed on the touch panel and contact the service representative.

Adjustment/Maintenance

Overview of Adjustment/Maintenance

If there is an image problem and the message to run adjustment or maintenance menu appears, run Adjustment/Maintenance in the system menu.

The table below lists the item you can carry out.

Item	Description
[Color Registration - Auto] [Color Registration - Manual]	Correct the color position to resolve color drift. ➔ Color Registration Procedure (page 720)
[Image Adjustment]	<p>Drum Refresh</p> <p>Remove image blur and white dots from the printout. It takes about 1 minute and 20 seconds. The time required may vary depending on the usage environment.</p> <p>Developer Refresh</p> <p>Adjust the printed image that is too light or incomplete, even though there is enough toner.</p> <p>Laser Scanner Cleaning</p> <p>Remove vertical white lines from the printout.</p> <p>Calibration</p> <p>Calibrate the device to ensure correct toner overlapping and consistency with the original tone.</p> <p>➔ Perform image adjustment (page 724)</p> <hr/> <p> NOTE</p> <ul style="list-style-type: none"> • Drum refresh cannot be performed while printing. Execute drum refresh after the printing is done. • Waiting time may be longer when the toner is refilled during developer refresh. • When correct toner overlapping is not ensured even after performing calibration, refer to the following: ➔ Color Registration Procedure (page 720)

Color Registration Procedure

When first installing the machine or moving it to a new location, color drift during printing may occur. Use this function to correct the color position of each of cyan, magenta and yellow to resolve color drift.

Auto registration and manual registration are available for Color Registration. Color drift can be largely corrected through auto registration. However, if it is not resolved or to perform more detailed settings, use the manual registration.

✔ IMPORTANT

Before performing color registration, be sure to perform Calibration. If color drift remains, perform color registration. By performing color registration without performing Calibration, the color drift will be resolved once, however, it may cause the serious color drift later.

Auto Correction

1 Load paper.

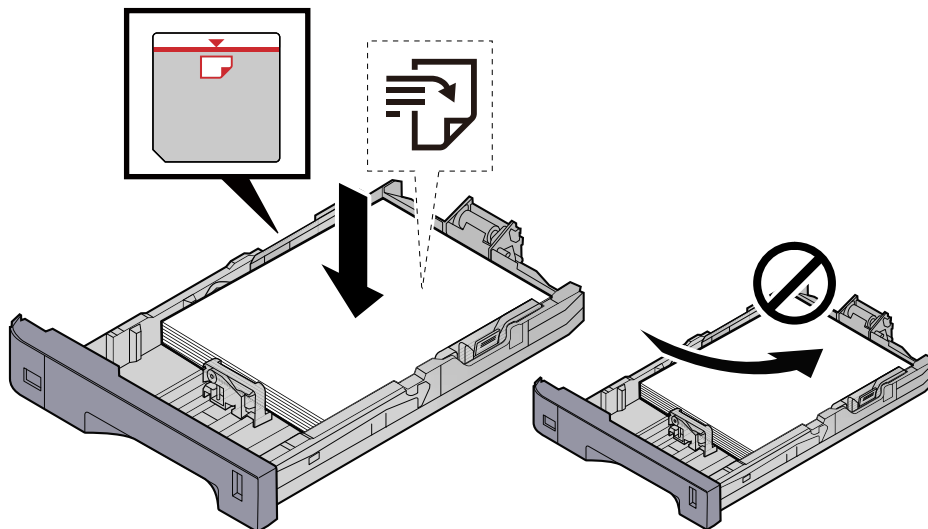

✔ IMPORTANT

- Load the paper with the print side facing up.
- After removing new paper from its packaging, fan out the paper before loading it in the cassettes.
→ [Precaution for Loading Paper \(page 144\)](#)
- Before loading the paper, be sure that it is not curled or folded. Paper that is curled or folded may cause paper jams.
- Ensure that the loaded paper does not exceed the level indicator (see illustration above).
- If paper is loaded without adjusting the paper length guide and paper width guide, the paper may skew or become jammed.

2 Display the screen.

- 1 [System Menu / Counter] key > [Adjustment/Maintenance] > "Image Adjustment" [Color Registration - Auto]

3 Print the chart

- 1 Select [Start].
A chart is printed.

Chart Example

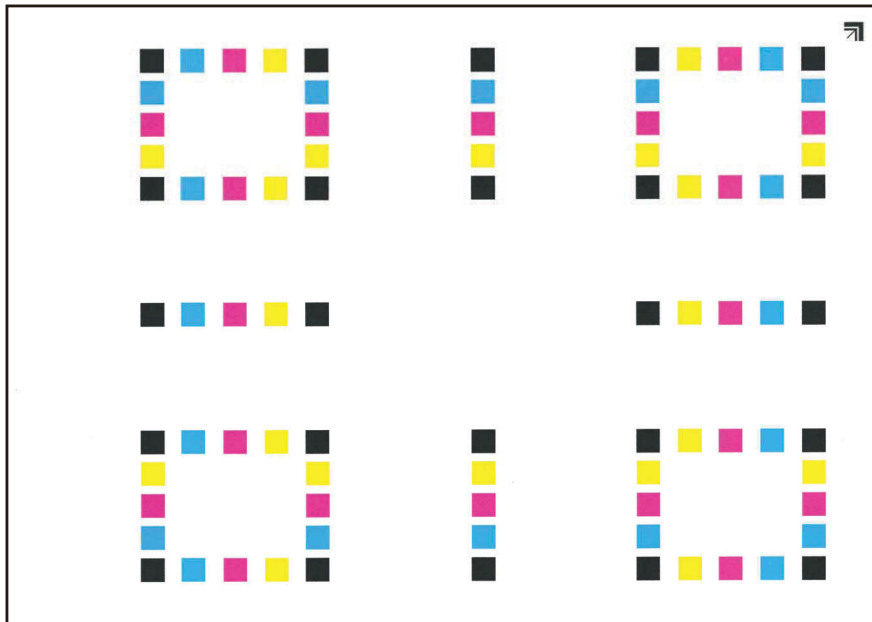

4 Perform the color registration.

- 1 As shown in the illustration, place the printed side down on the platen with the edge with the arrows toward the back.

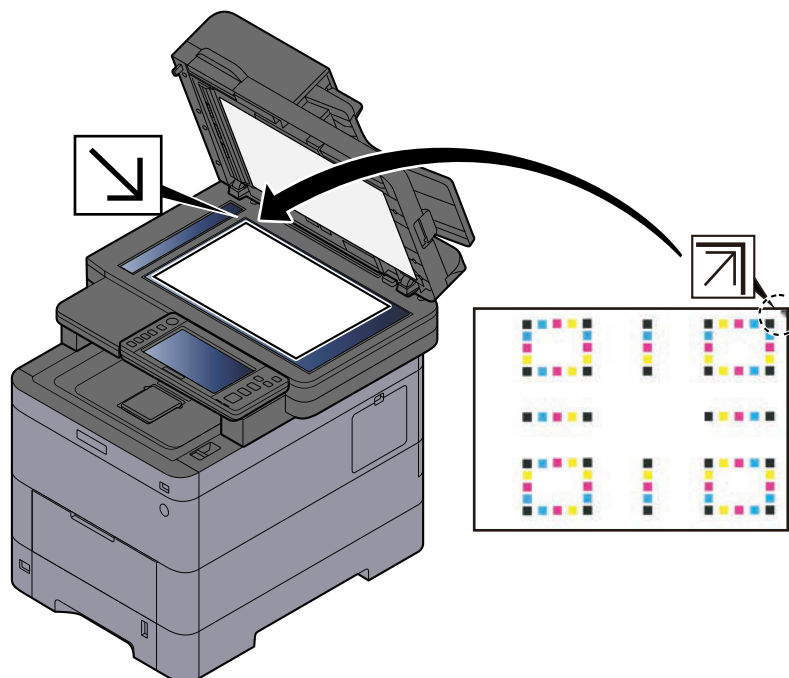

- 2 Select [Start] to scan the chart.
When scanning is finished, color printing position correction starts.
- 3 Select [OK] after color registration is complete.

Manual Correction

1 Load paper.

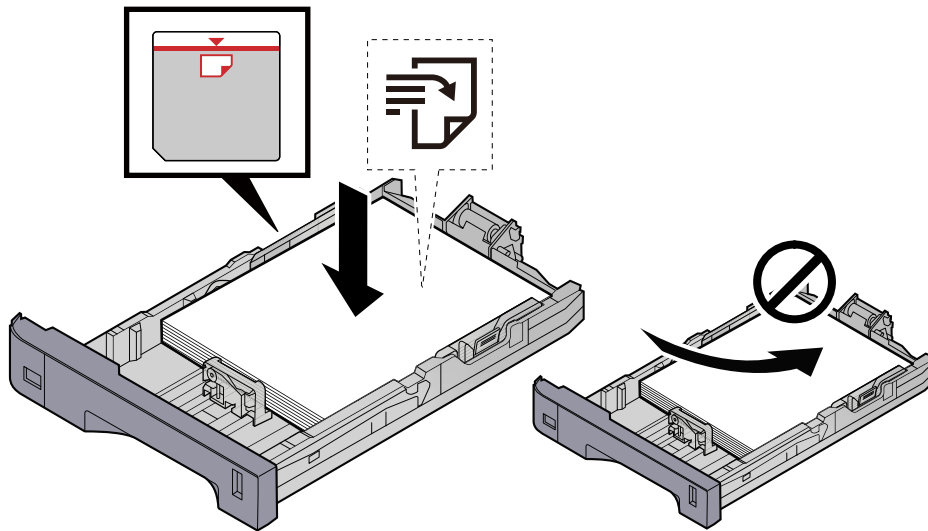

✓ IMPORTANT

- Load the paper with the print side facing up.
- After removing new paper from its packaging, fan out the paper before loading it in the cassettes.
 ➔ [Precaution for Loading Paper \(page 144\)](#)
- Before loading the paper, be sure that it is not curled or folded. Paper that is curled or folded may cause paper jams.
- Ensure that the loaded paper does not exceed the level indicator (see illustration above).
- If paper is loaded without adjusting the paper length guide and paper width guide, the paper may skew or become jammed.

2 Display the screen.

- 1 [System Menu / Counter] key > [Adjustment/Maintenance] > "Image Adjustment" [Color Registration - Manual]

3 Print the chart.

- 1 Select [Print Chart].

A chart is printed. On the chart, for each of M (magenta), C (cyan) and Y (yellow), charts for H-1 to 5 and V-1 to 5 are printed.

Chart Example

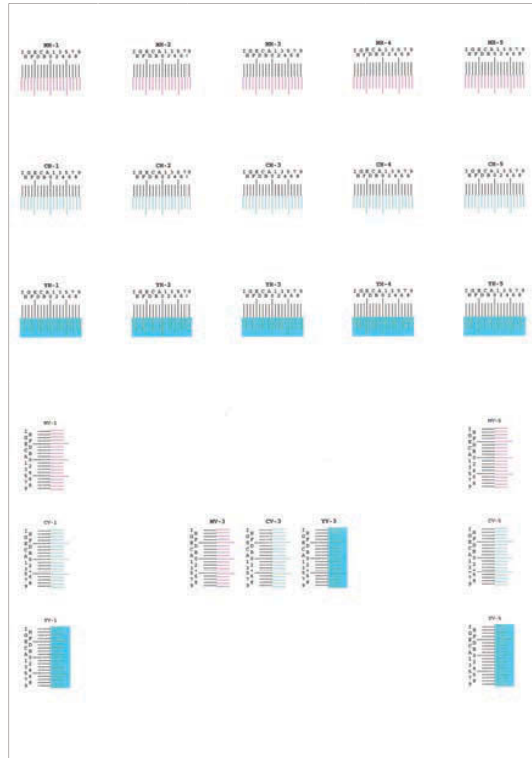

4 Enter the appropriate value.

- 1 Find the location on each chart where 2 lines most closely match. If this is the 0 position, registration for that color is not required. For the illustration, B is the appropriate value.

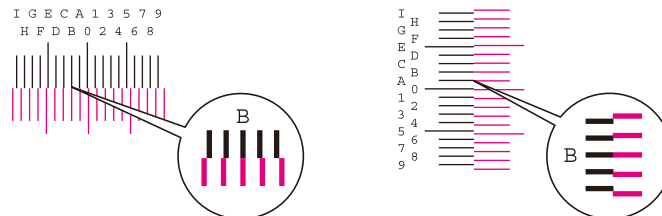

From charts H-1 to H-5, read the values from H-1 to H-5.

From charts V-1 to V-5, read only the values from V-3 (center).

- 2 Select [Registration].
- 3 Select the chart to be corrected.
- 4 Select the values read from the chart.
- 5 Repeat steps 3 and 4 to enter the registration values for each chart.
- 6 Select [Start] after all values have been entered. Color registration begins.
- 7 Select [OK] after color registration is complete.

Perform image adjustment

1 Display the screen

- 1 [System Menu / Counter] key > [Adjustment/Maintenance] > "Image Adjustment" [Image Adjustment]

2 Execute.

- 1 Select the item to execute.

- 2 Execute it.

If you select multiple items, they will start in sequence.

Clearing Paper Jams

If a paper jam occurs, the touch panel will display "Paper jam." and the machine will stop.

Jam Location Indicators

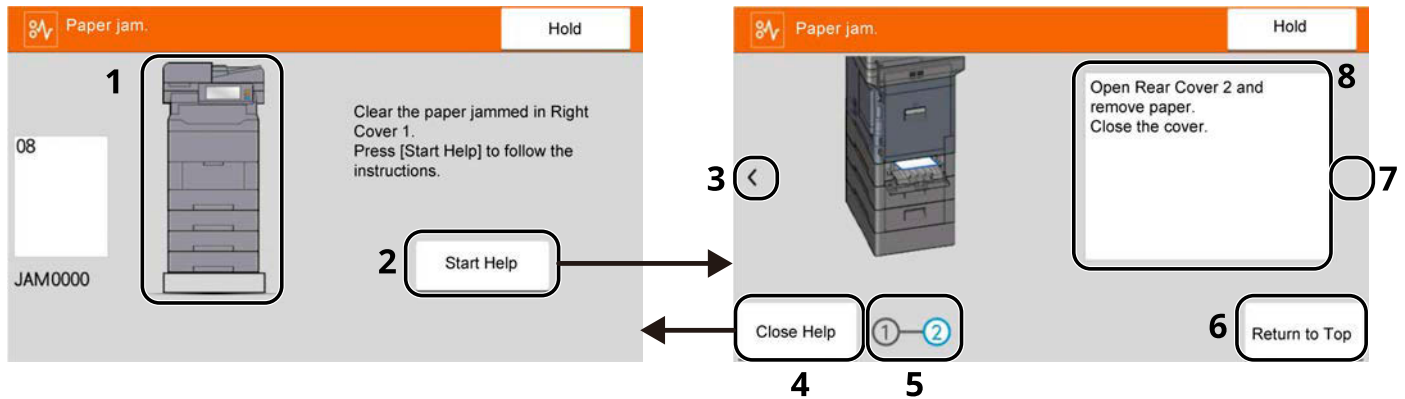

- 1 Shows the location of a paper jam.
- 2 Shows the Help screen. The Help screen shows the procedure to clear the jam.
- 3 Returns to the previous step.
- 4 Closes the Help screen and returns to the original screen.
- 5 Shows the selected step.
- 6 Returns to step 1.
- 7 Advances to the next step.
- 8 Shows the removal procedure.

If a paper jam occurs, the location of the jam will be displayed on the touch panel as well as the clearing instructions.

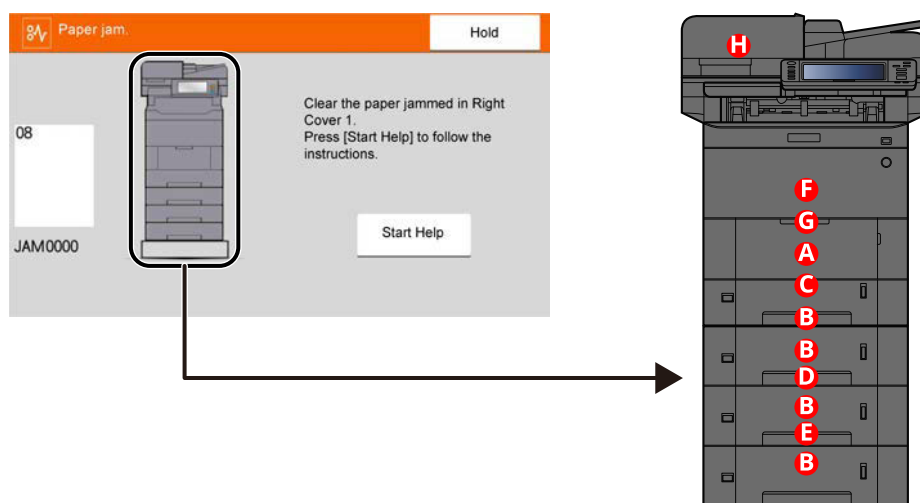

Paper Jam Location Indicator	Paper Jam Location
A	Multipurpose Tray ➔ Remove any jammed paper in the Multipurpose Tray (page 727)
B	Cassette 1 to 5 ➔ Remove paper jams from Cassette 1 to Cassette 5 (page 730)
C	Rear Cover 1 (Feed) ➔ Remove the paper jammed in the Rear Cover 1 (Feed) (page 732)
D	Rear Cover 2 ➔ Remove the paper jammed in the Rear Cover 2 (page 733)
E	Rear Cover 3 ➔ Remove the paper jammed in the Rear Cover 3 (page 734)
F	Rear Cover 1 ➔ Remove the paper jammed in the Rear Cover 1 (page 735)
G	Duplex Unit ➔ Remove any jammed paper in Duplex Unit (page 737)
H	Document Processor ➔ Remove any jammed paper in the Document Processor (Reverse Automatic) (page 739)

After you remove the jam, the machine will warm up again and the error message will be cleared. The machine resumes with the page that was printing when the jam occurred.

Remove any jammed paper in the Multipurpose Tray

CAUTION

- Do not reuse jammed papers.
 - If the paper tears during removal, be sure to remove any loose scraps of paper from inside the machine. Scraps of paper left in the machine could cause subsequent jamming.
-

1 Remove any jammed paper.

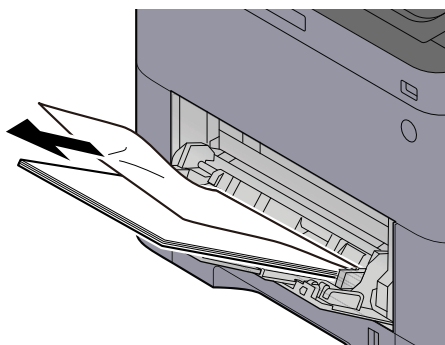

2 Remove all the paper.

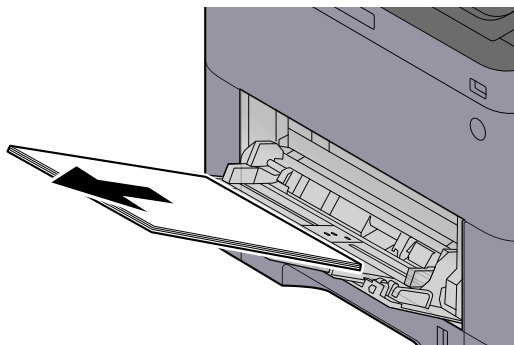

3 Close the multipurpose tray and pull out cassette 1.

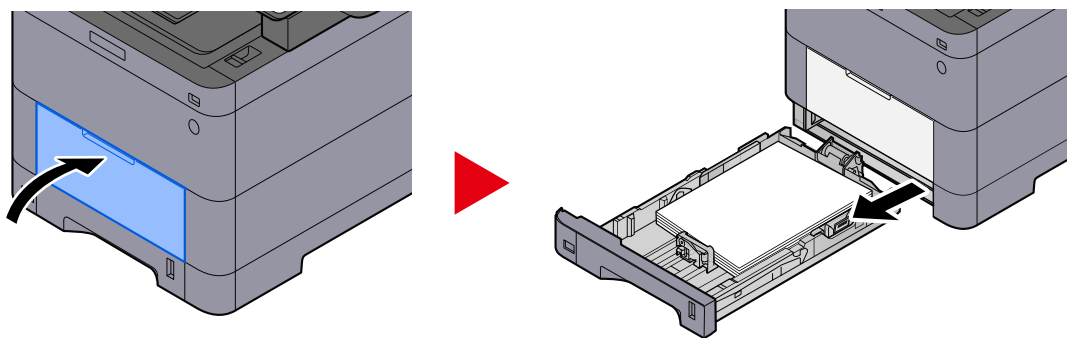

4 Open the feed cover.

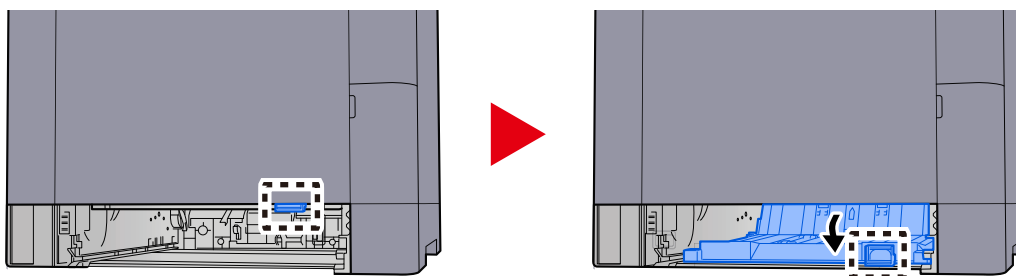

5 Remove any jammed paper.

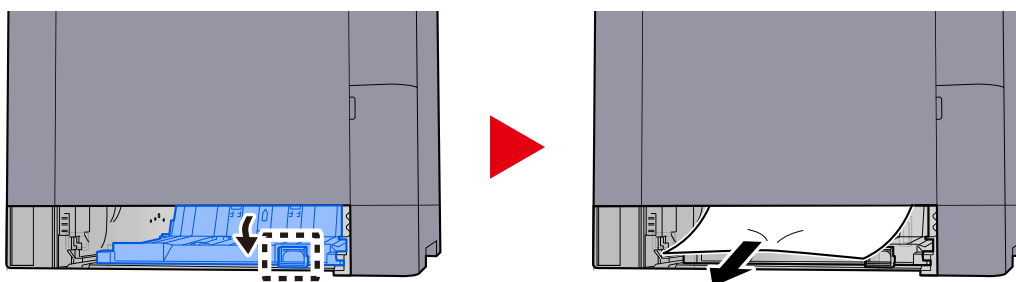

- 6** Return the feed cover to its original position and return cassette 1 to its original position.

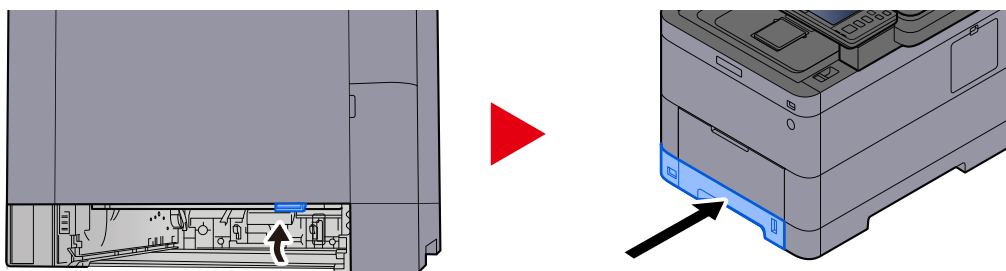

- 7** Open the multipurpose tray and reload the paper.

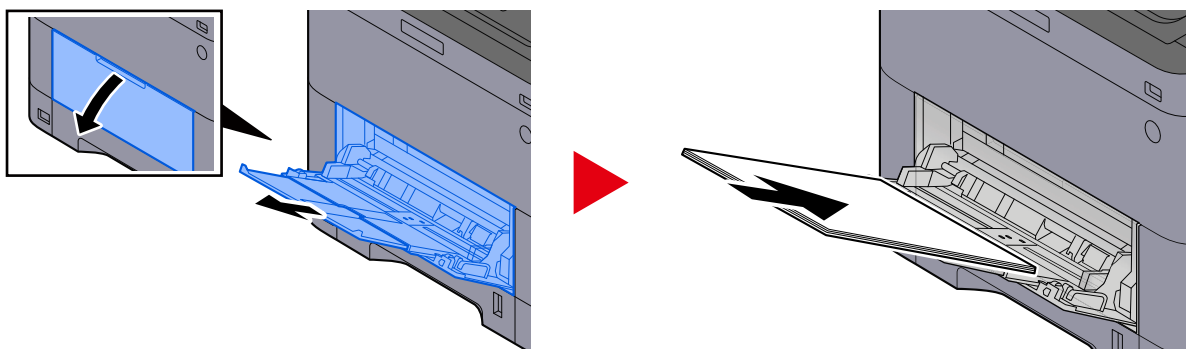

Remove paper jams from Cassette 1 to Cassette 5

The procedure for handling paper jams in cassette 1 to cassette 5 is the same. Cassette 1 is used as an example here.

CAUTION

- Do not reuse jammed papers.
- If the paper tears during removal, be sure to remove any loose scraps of paper from inside the machine. Scraps of paper left in the machine could cause subsequent jamming.

1 Pull Cassette 1 out toward you until it stops.

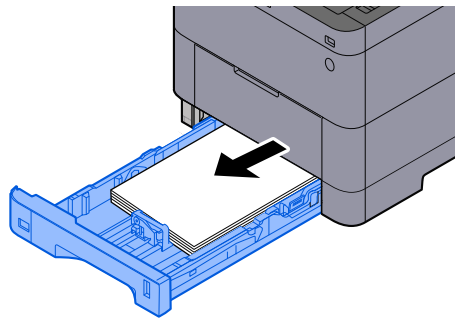

2 Remove any jammed paper.

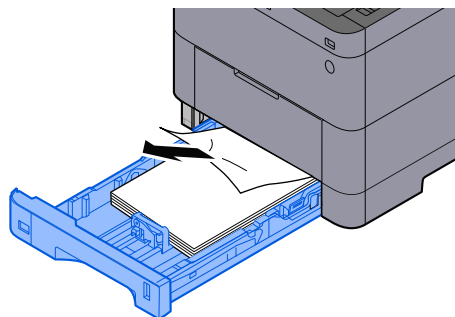

3 Push Cassette 1 back in.

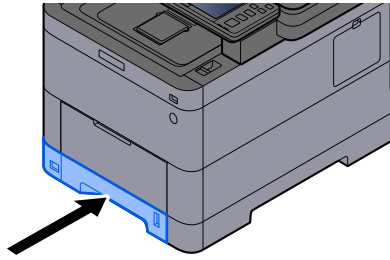

Remove the paper jammed in the Rear Cover 1 (Feed)

- 1 Open the Rear Cover 1.

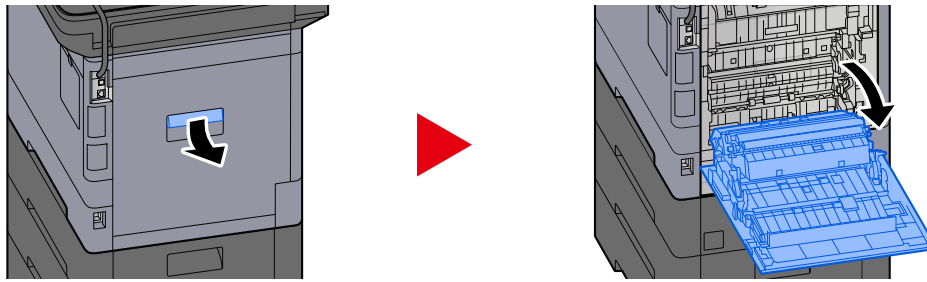

CAUTION

Some parts are very hot inside the machine. Exercise caution as there is a risk of burn injury.

- 2 Remove the jammed paper and return the Rear Cover 1 to its original position.

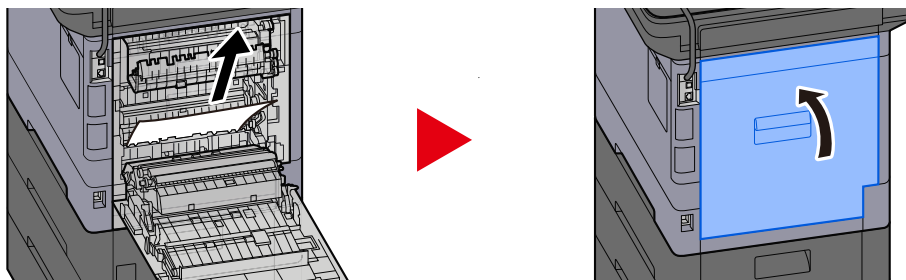

- 3 Open the Rear Cover 2 and remove the jammed paper.

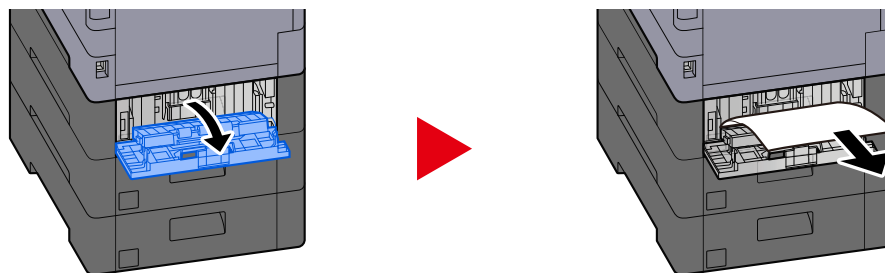

- 4 Return the Rear Cover 2 to the original position.

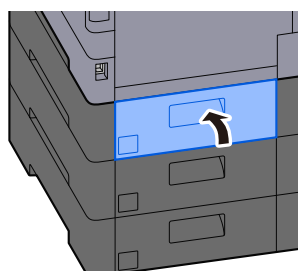

Remove the paper jammed in the Rear Cover 2

- 1 Open the Rear Cover 2 and remove the jammed paper.

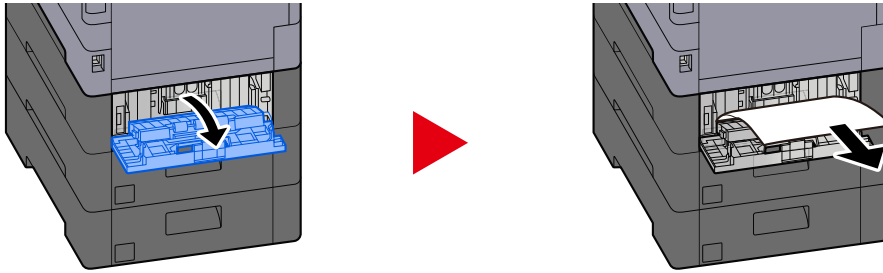

 **NOTE**

If you cannot remove the paper, do not force it out.

➔ [Remove the paper jammed in the Rear Cover 1 \(Feed\) \(page 732\)](#)

- 2 Return the Rear Cover 2 to the original position.

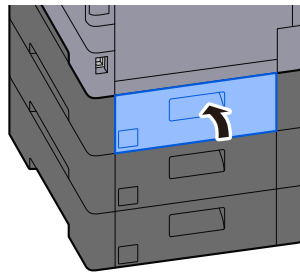

- 3 Open the Rear Cover 3 and remove the jammed paper.



- 4 Return the Rear Cover 3 to the original position.

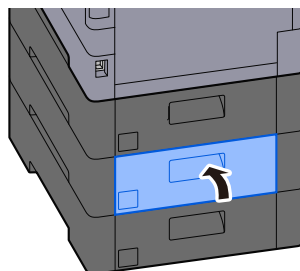

Remove the paper jammed in the Rear Cover 3

- 1 Open the Rear Cover 3 and remove the jammed paper.

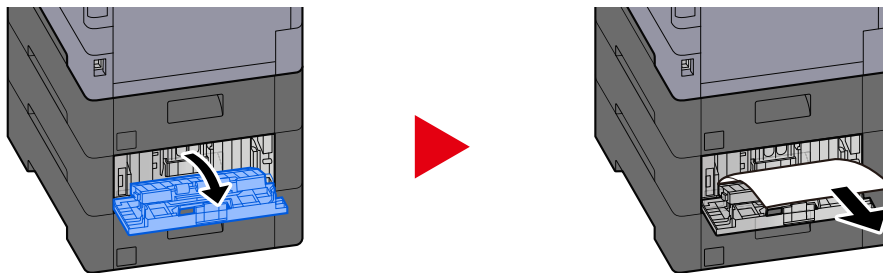

 **NOTE**

If you cannot remove the paper, do not force it out.

➔ [Remove the paper jammed in the Rear Cover 1 \(Feed\) \(page 732\)](#)

- 2 Return the Rear Cover 3 to the original position.

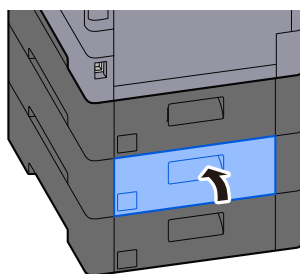

Remove the paper jammed in the Rear Cover 1

1 Open the Rear Cover 1

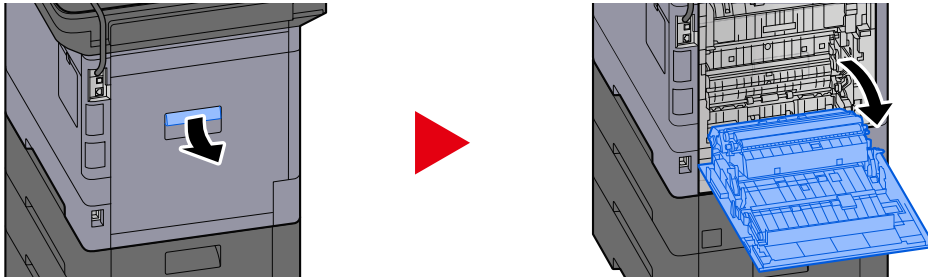

CAUTION

Some parts are very hot inside the machine. Exercise caution as there is a risk of burn injury.

2 Remove any jammed paper.

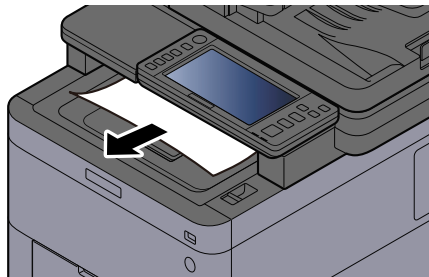

3 Open cover A1 and remove the jammed paper

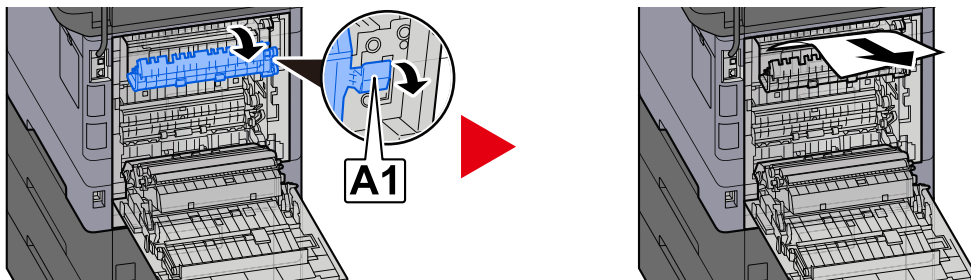

4 Remove any jammed paper.

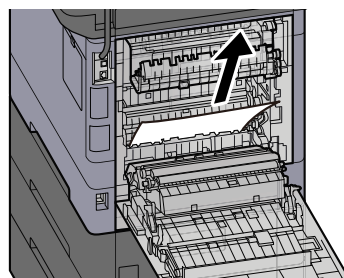

5 Open cover A2 and remove the jammed paper

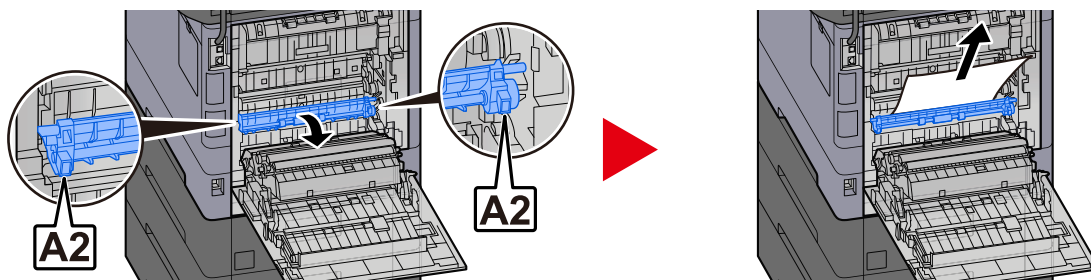

6 Return the rear cover 1 to the original position.

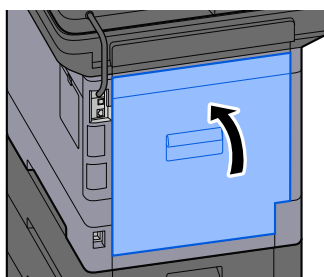

Remove any jammed paper in Duplex Unit

1 Open the Rear Cover 1

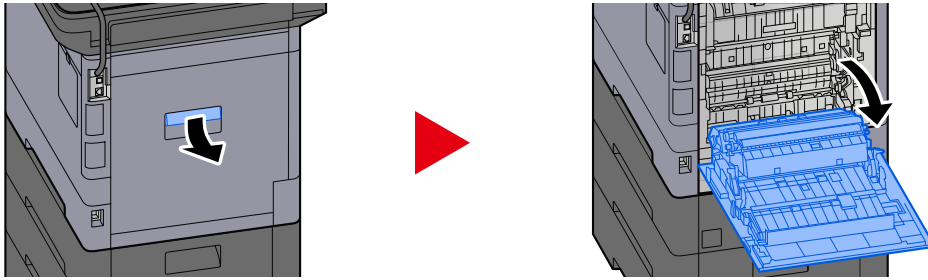

CAUTION

Some parts are very hot inside the machine. Exercise caution as there is a risk of burn injury.

2 Remove any jammed paper.

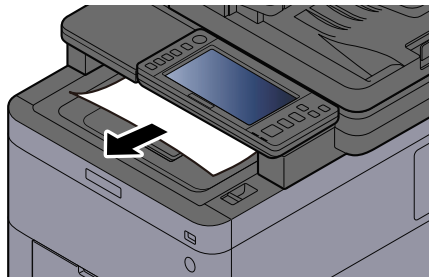

3 Open cover A1 and remove the jammed paper

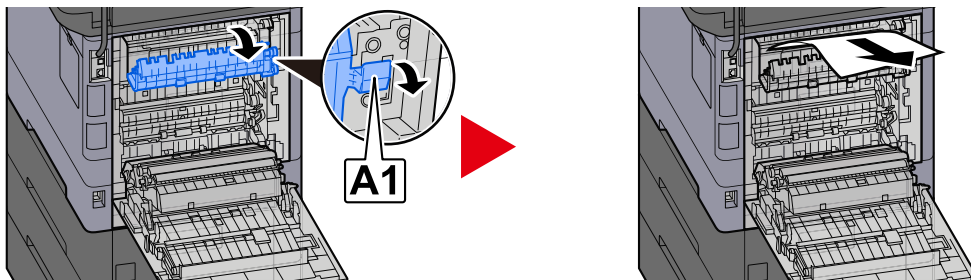

4 Remove any jammed paper.

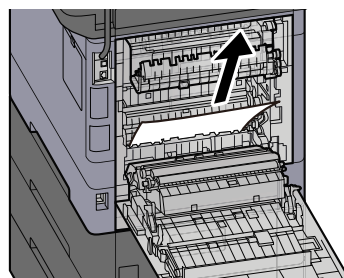

5 Open cover A2 and remove the jammed paper

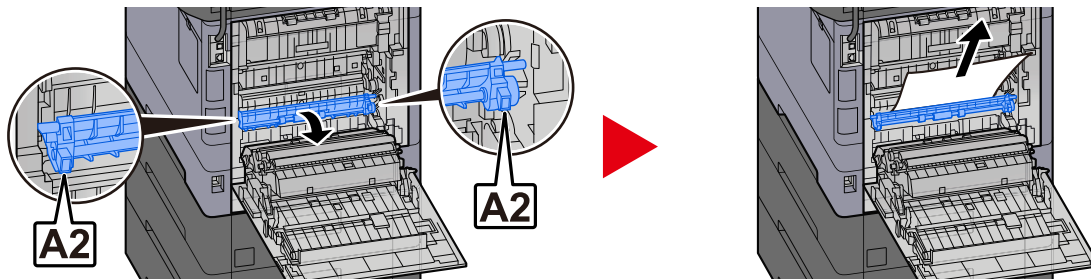

6 Return the Unit A3 to the original position

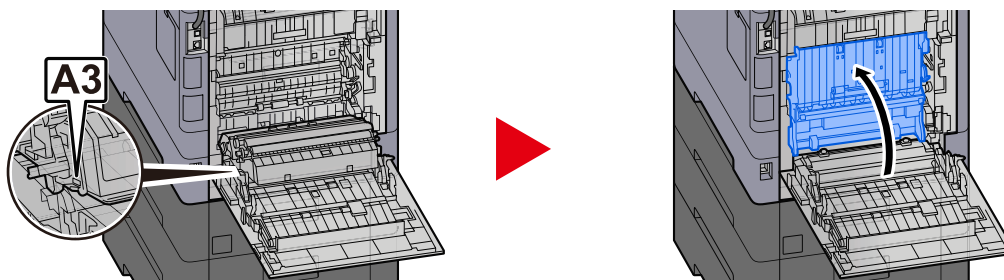

7 Remove any jammed paper.

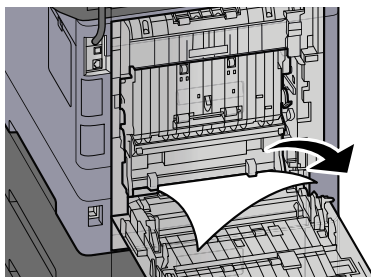

8 Return the rear cover 1 to the original position.

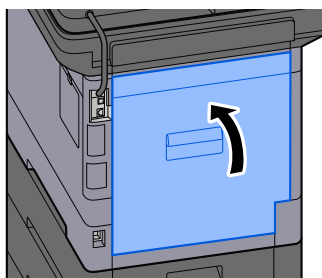

Remove any jammed paper in the Document Processor (Reverse Automatic)

CAUTION

If the paper tears during removal, be sure to remove any loose scraps of paper from inside the machine. Scraps of paper left in the machine could cause subsequent jamming.

- 1 Remove the originals from the Original Table.

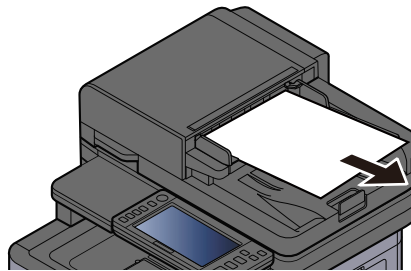

- 2 Open the Document Processor cover and remove the jammed paper.

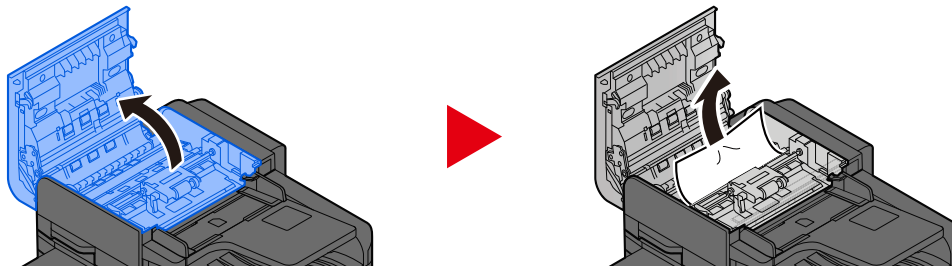

- 3 Turn dial C to remove the jammed paper.

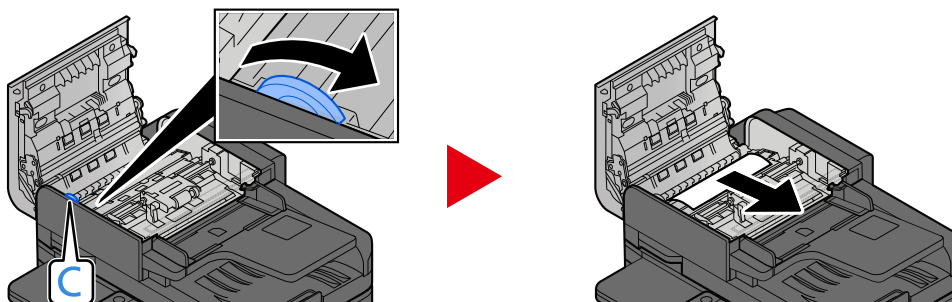

4 Return the cover to the original position.

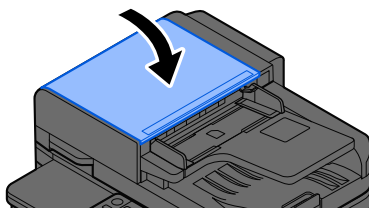

11 Appendix

Optional Equipment

Overview of Optional Equipment

The following optional equipment is available for the machine.

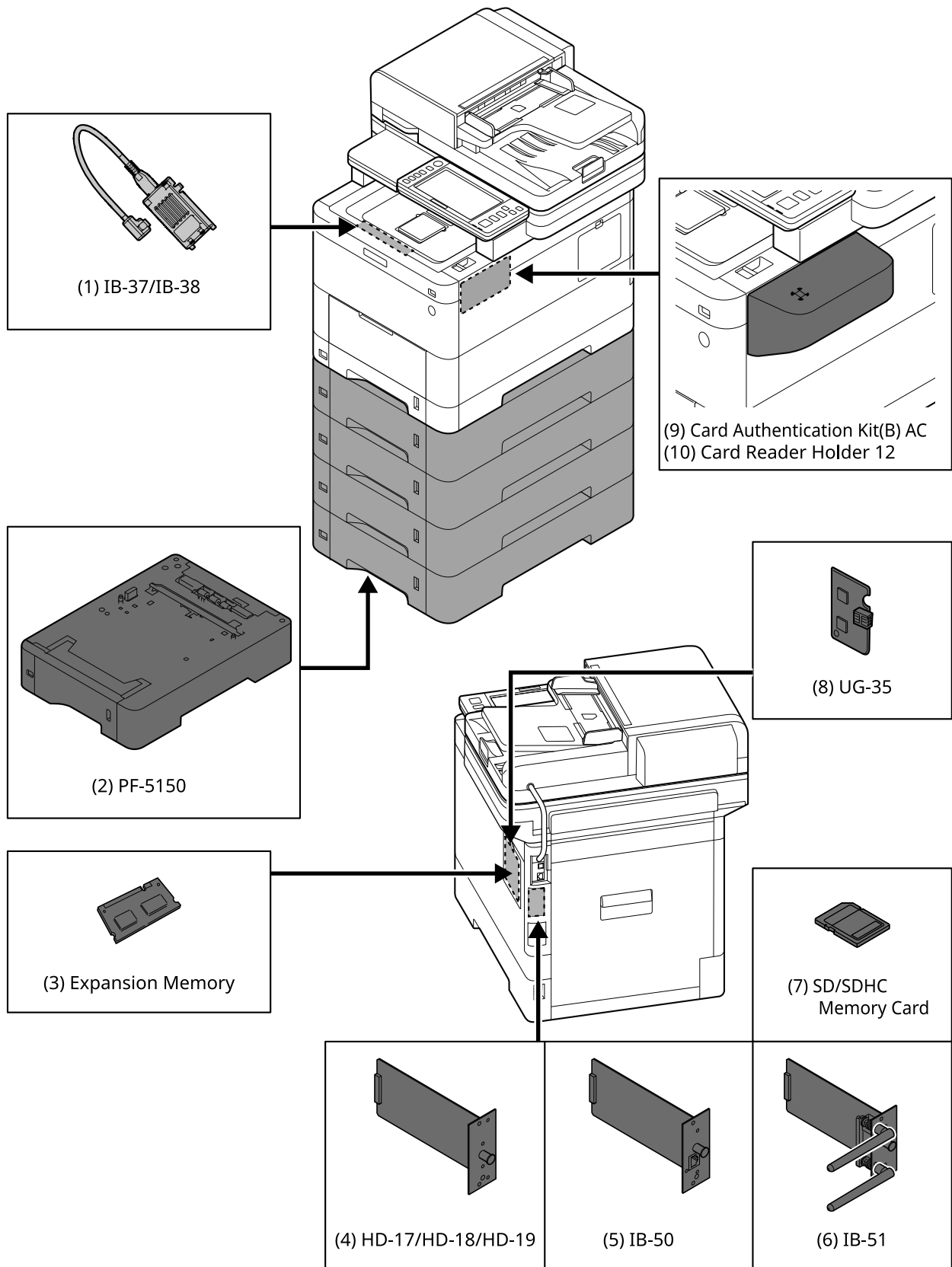

1 IB-37/IB-38 <Wireless network interface (USB: 5GHz/2.4GHz)>

A wireless network interface card that supports the wireless network (Wireless LAN) specifications IEEE802.11n (max. 65Mbps) and 11g/b. In addition, network printing is available without using the wireless LAN router since Wi-Fi Direct is supported.

2 PF-5150 <Paper feeder>

(For TASKalfa MA4500ci) It is possible to add 4 drawers that is same as the cassette of the main unit.

(For TASKalfa MA3500ci) It is possible to add 3 drawers that is same as the cassette of the main unit.

The way of loading paper is same as the standard cassette.

3 Expansion memory

By adding the memory, it will be possible to perform more multiple jobs at the same time. By installing the optional expansion memory, the memory can be expanded to 3,072MB as a maximum.

4 SSD is for storing printing data. When printing the multiple prints, there are advantages such as the high speed printing with the electronic sort function. And also, it is possible to use the document box function.

5 IB-50 <Network interface>

The network interface kit is the high speed interface supported to the communication speed of 1 giga bit/sec. Since TCP/IP, NetBEUI protocol are supported, it is possible make the network printing under the various environment such as Windows, Macintosh, UNIX, etc..

➔ **IB-50 Operation Guide**

6 IB-51 <Wireless network interface (KUIO: 2.4GHz)>

A wireless LAN network interface card that supports the wireless LAN specifications IEEE802.11n (max. 300Mbps) and 11g/b. It is possible to set for various OS and network protocol with bundled utilities.

➔ **IB-50 Operation Guide**

7 SD/SDHC Memory Card

SD/SDHC memory card is the micro-chip card that the option font, macro, form, etc. can be written. Insert SDHC memory card (Max. 32GB) and SD memory card (Max. 2GB) into the memory card slot.

8 UG-35 <Trusted Platform Module>

It is possible to protect the confidential information safely with this option. The encryption key used for the encrypted confidential information is stored in the exclusive storing area of the TPM chip. Since it is not possible to scan in this storing area from the outside of the TPM, the confidential information can protect safely.

9 Card Authentication Kit(B) AC <IC card authentication kit (Activate)>

It is possible to make the user authentication with IC card. In order to perform the user authentication with IC card, IC card information has to be registered to the local user list in advance.

Refer to the following for the method of the registration.

➔ **IC CARD AUTHENTICATION KIT (B) OPERATION GUIDE**

10 Card Reader Holder 12 <Card reader attachment plate>

In order to install Card reader, it is possible to use it as an installation space.

Software option

1 UG-33 AC <ThinPrint expansion kit (Activate)>

It is possible print the print data directly even without the print driver.

2 Scan Extension Kit(A) AC <Scan function expansion kit (Activate)>

This kit is the option that the OCR function can be used in the applications of this main unit.

In order to use this function, it is necessary to install SSD or SD/SDHC memory card.

➔ [SD/SDHC Memory Card \(page 744\)](#)

In order to use this function, it is necessary to install the application and OCR dictionary.

➔ [Overview of the Applications \(page 746\)](#)

➔ [\[OCR Dictionary Installation\] \(page 508\)](#)

Reading the SD/SDHC Memory Card

Once inserted in the machine's slot, the contents of the SD/SDHC memory card can be read from the operation panel or automatically when you power on or reset the machine.

Overview of the Applications

The applications listed below are installed on this machine.

- Data Security Kit
- ThinPrint Option
This can be used on a trial basis for a limited time.
- Card Authentication Kit
This can be used on a trial basis for a limited time.
- OCR Scan Activation Kit
This can be used on a trial basis for a limited time.

NOTE

- Restrictions such as the number of times the application can be used during the trial period differ depending on the application.
 - If you change the date/time while using the trial version of an application, you will no longer be able to use the application.
-

Starting Application Use

1 Display the screen.

[System Menu / Counter] key > [Add/DeleteApplication] > "Optional Function" [Optional Function List]

NOTE

If the user authentication screen appears, log in with a user who has the privilege to configure this setting. If you do not know your login user name or password, please contact your administrator.

2 Select the desired application > [Activate]

You can view detailed information on the selected application by selecting  (information icon).

3 Enter the license key > [Official]

Some applications do not require you to enter a license key. If the license key entry screen does not appear, go to step 4.

To use the application as a trial, select [Trial] without entering the license key.

4 Select [Start] in the confirmation screen.

NOTE

- If you started the Data Encryption/Overwrite or UG-33 AC, turn the power OFF/ON.
 - Icons of activated application are displayed in the Home screen.
-

Checking Details of Application

1 Display the screen.

[System Menu / Counter] key > [Add/DeleteApplication] > [Optional Function] [Optional Function List]



NOTE

If the user authentication screen appears, log in with a user who has the privilege to configure this setting. If you do not know your login user name or password, please contact your administrator.

2 Select (information icon) for the application whose detailed information you want to check.

The detail information are available on the selected application.

The items that can be referenced are as follows:

- Function Name
 - License
 - Remaining Trial Counts
 - Expiration Date of Trial
 - Status
-



NOTE

To extend the trial period, select [Extend].

Character Entry Method

To enter characters for a name, use the on-display keyboard in the touch panel following the steps as explained below.

NOTE

Keyboard Layout

"QWERTY", "QWERTZ" and "AZERTY" are available as keyboard layouts the same as a PC keyboard. Select the [System Menu / Counter] key, [DeviceSettings], [Keyboard] and then [Keyboard Layout] to choose the desired layout. "QWERTY" layout is used here as an example. You may use another layout following the same steps.

Entry Screens

Lower-case Letter Entry Screen

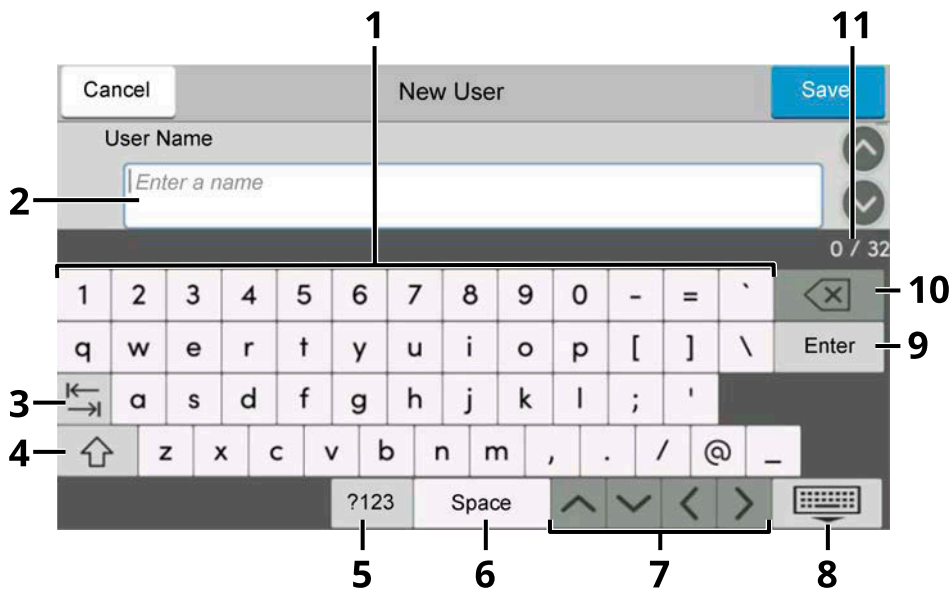

- 1 Keyboard
Select the character to enter.
- 2 Input box
Enter characters in the selected box.
- 3 Tab key
Select to move to the next input box.
- 4 Shift key
Select to switch between upper case and lower case.
- 5 ?123 / Character
Select the characters that are entered.
- 6 Space key
Select to insert a space.

7 Cursor key

Select to move the cursor on the display.

8 Close key

Select to close the entry screen.

9 Enter key

Select to finalize entry and return to the screen before the entry.

10 Backspace key

Select to delete a character to the left of the cursor.

11 Input / Limit display

Displays maximum number of characters and the number of characters entered.

Upper-case Letter Entry Screen

Select the Shift key.

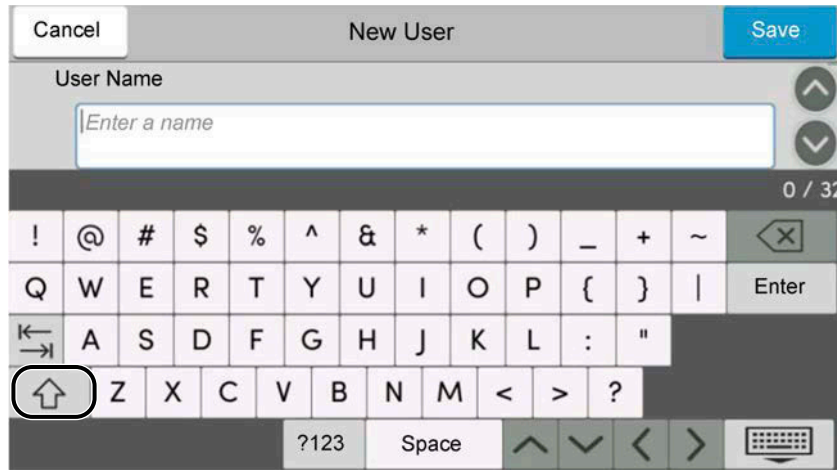

Number/Symbol Entry Screen

Select ?123.

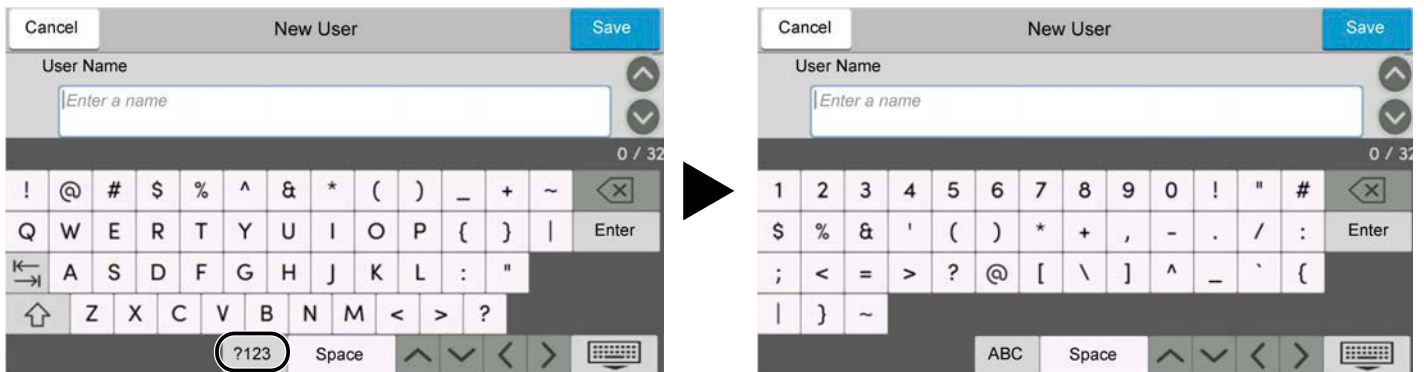

Entering Characters

Follow the steps below to enter 'List #1' for an example

1 Enter 'List', (space).

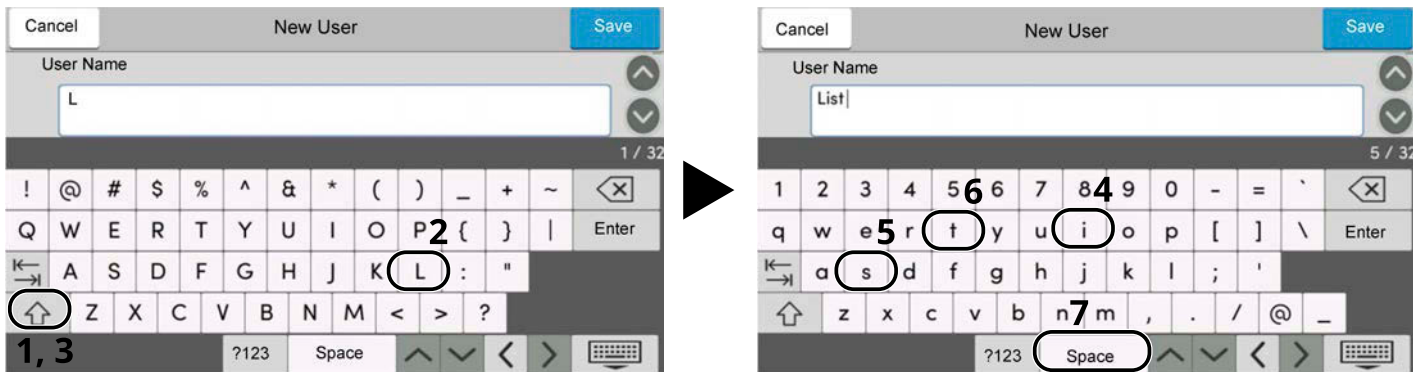

To switch between upper case and lower case, select the Shift key.

2 Enter '#' and '1'.

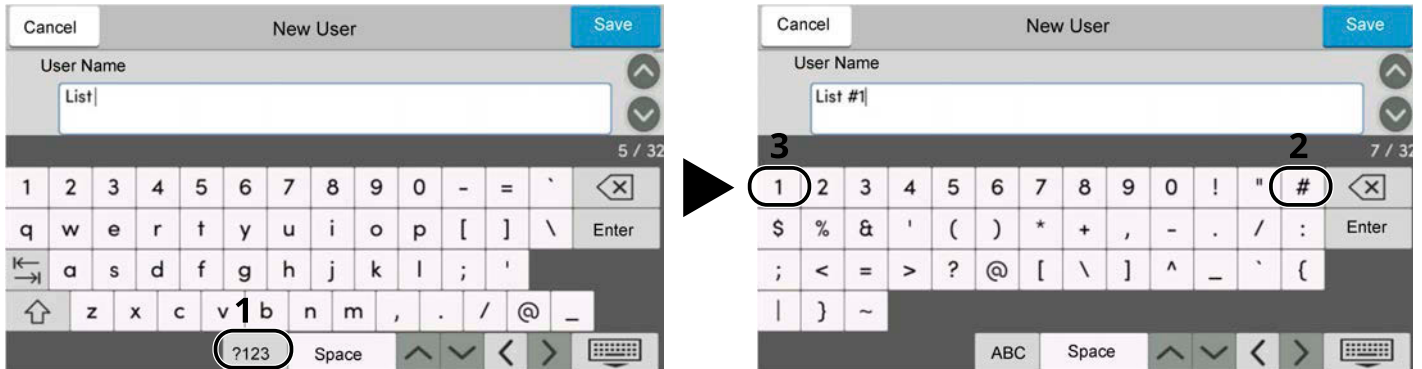

To enter numbers or symbols, select #123.

3 Check that the entry is correct.

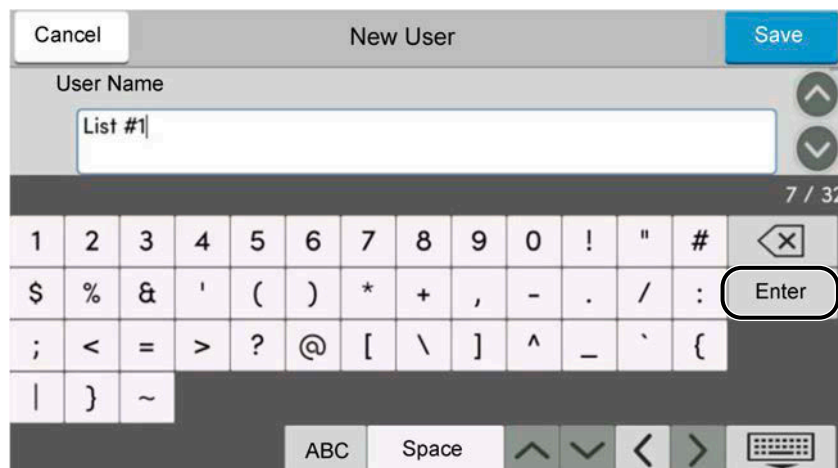

Check that the entry is correct. Select enter.

About Paper

This section explains the paper sizes and types that can be used in the paper source.

For details on the sizes, types, and number of sheets of paper that can be loaded in each paper tray, refer to the following:

→ [Specifications \(page 760\)](#)

Basic Paper Specifications

This machine is designed to print on standard copy paper as used in regular ('dry') copiers and page printers such as laser printers. It also supports a variety of other types of paper that conform to the specifications given in this appendix.

Be careful when choosing paper. Paper unsuitable for the machine may cause jams or may be wrinkled.

Supported Paper

Use standard copy paper for regular copiers or laser printers. The printing quality will be affected by the quality of paper. Poor quality paper may result in unsatisfactory output.

Basic Paper Specifications

The following table lists the specifications of paper that is supported with this machine.

Criteria	Specifications
Weight	Cassettes: 60 to 220 g/m ²
	Multipurpose tray: 60 to 220 g/m ²
Dimensional accuracy	±0.7 mm
Squareness of corners	90° ±0.2°
Moisture Content	4 to 6%
Pulp content	80% or more

NOTE

Some recycled paper does not meet requirements for use with this machine as listed in the Basic Paper Specifications shown below, such as moisture or pulp content. For this reason, we recommend purchasing a small amount of recycled paper as a sample for testing prior to use. Choose recycled paper that gives the best printing results and contains low levels of paper dust.

We are not responsible for the problems occurred from the use of paper that does not conform to our specifications.

Choosing the Appropriate Paper

This section describes guidelines for choosing paper.

Condition

Avoid using paper with bent corners or that is curled, dirty, or torn. Do not use paper that has a rough surface or paper fiber lint, or that is especially delicate. Using such paper can cause poor print quality. In addition, poor paper feeding can cause paper jams and shorten the life of the machine. Use paper with a smooth and even surface. However, do not use paper that has been surface-treated, such as coating, as it may damage the drum and fusing unit.

Ingredients

Do not use paper such as paper that has been coated or surface-treated or paper that contains plastic or carbon. Those types of paper may produce harmful fumes from the heat of printing and may damage the drum.

Be sure to use standard paper that contains at least 80% pulp. Be sure to use standard paper with 20% or less of the paper content consisting of cotton or other fibers.

Smoothness

The paper surface should be smooth, but it must be uncoated. With paper that is too smooth and slippery, several sheets may accidentally be supplied at once, causing jams.

Basis Weight

In countries that use the metric system, basis weight is the weight in grams of one sheet of paper one square meter in area. In the United States, basis weight is the weight in pounds of one ream (500 sheets) of paper cut to the standard size (or trade size) for a specific grade of paper.

Paper that is too heavy or too light may be supplied incorrectly or cause paper jams, which may cause excessive wear of the machine. Mixed paper weight (i.e., thickness) may cause several sheets to be supplied at once accidentally and may also cause blurring or other printing problems if the toner fails to adhere correctly.

Moisture Content

Paper moisture content is the ratio of moisture to dryness expressed as a percentage. Moisture affects how the paper is supplied, the electrostatic chargeability of the paper, and how the toner adheres.

Paper moisture content varies depending on the relative humidity in the room. High relative humidity causes paper to become damp, making the edges expand so it appears wavy. Low relative humidity causes paper to lose moisture, making the edges tighten and weakening print contrast.

Wavy or tight edges may cause the paper to slip when it is supplied. Try to keep the moisture content between 4 to 6%.

To maintain the right level of moisture content, bear in mind the following considerations.

- Store paper in a cool, well-ventilated place.
- Store paper flat and unopened in the package. Once the package is opened, reseal it if the paper is not to be used for a while.
- Store paper sealed in the original package and box. Put a pallet under the box to keep it raised above the floor. Especially during rainy seasons keep the paper a sufficient distance away from wooden or concrete floors.
- Before using paper that has been stored, keep it at the proper moisture level for at least 48 hours.
- Do not store paper where it is exposed to heat, sunlight, or dampness.

Other Paper Specifications

Porosity:

The density of the paper fibers.

Stiffness:

Paper must be stiff enough or it may buckle in the machine, causing jams.

Curl:

Most paper naturally tends to curl after the package is opened. When paper passes through the fixing unit, it curls upward slightly. To deliver flat printouts, load the paper so that the curl faces towards the bottom of the paper tray.

Static electricity:

During printing, paper is electrostatically charged so that the toner adheres. Choose paper that can be discharged quickly so that copies do not cling together.

Whiteness:

Paper whiteness affects print contrast. Use whiter paper for sharper, brighter copies.

Quality:

Machine problems may occur if sheet sizes are not uniform or if corners are not square, edges are rough, sheets are uncut, or edges or corners are crushed. In order to prevent these problems, be especially careful when you cut the paper yourself.

Packaging:

Choose paper that is properly packaged and stacked in boxes. Ideally, the packaging itself should have been treated with a coating to inhibit moisture.

Specially treated paper:

We do not recommend printing onto the following types of paper, even if it conforms to the basic specifications. When you use these kinds of paper, purchase a small amount first as a sample to test.

- Glossy paper
- Watermarked paper
- Paper with an uneven surface
- Perforated paper

Paper Sizes that can be Used with This Machine

Paper of the following sizes is supported by the machine.

Measurements in the table take into account a ± 0.7 mm dimensional accuracy for length and width. Corner angles must be $90^\circ \pm 0.2^\circ$.

Paper Size	Cassette 1	Cassette to 5	Multipurpose Tray
Envelope Monarch (3-7/8 × 7-1/2")	Paper of this size cannot be set	Paper of this size can be set	Paper of this size can be set
Envelope #10 (4-1/8 × 9-1/2")	Paper of this size cannot be set	Paper of this size can be set	Paper of this size can be set
Envelope DL (110 × 220 mm)	Paper of this size cannot be set	Paper of this size can be set	Paper of this size can be set

Paper Size	Cassette 1	Cassette to 5	Multipurpose Tray
Envelope C5 (162 × 229 mm)	Paper of this size cannot be set	Paper of this size can be set	Paper of this size can be set
Executive (7-1/4 × 10-1/2")	Paper of this size can be set	Paper of this size can be set	Paper of this size can be set
Letter	Paper of this size can be set	Paper of this size can be set	Paper of this size can be set
Legal	Paper of this size can be set	Paper of this size can be set	Paper of this size can be set
A4 (297 × 210 mm)	Paper of this size can be set	Paper of this size can be set	Paper of this size can be set
B5 (257 × 182 mm)	Paper of this size can be set	Paper of this size can be set	Paper of this size can be set
A5-R	Paper of this size can be set	Paper of this size can be set	Paper of this size can be set
A5 (210 × 148 mm)	Paper of this size can be set	Paper of this size cannot be set	Paper of this size can be set
A6 (148 × 105 mm)	Paper of this size can be set	Paper of this size cannot be set	Paper of this size can be set
B6 (182 × 128 mm)	Paper of this size can be set	Paper of this size can be set	Paper of this size can be set
Envelope #9 (3-7/8 × 8-7/8")	Paper of this size cannot be set	Paper of this size can be set	Paper of this size can be set
Envelope #6 (3-5/8 × 6-1/2")	Paper of this size cannot be set	Paper of this size can be set	Paper of this size can be set
ISO B5 (176 × 250 mm)	Paper of this size can be set	Paper of this size can be set	Paper of this size can be set
Hagaki (Cardstock) (100 × 148 mm)	Paper of this size cannot be set	Paper of this size cannot be set	Paper of this size can be set
Oufuku hagaki (Return postcard) (148 × 200 mm)	Paper of this size cannot be set	Paper of this size cannot be set	Paper of this size can be set
Oficio II	Paper of this size can be set	Paper of this size can be set	Paper of this size can be set
216 × 340 mm	Paper of this size can be set	Paper of this size can be set	Paper of this size can be set
16K (273 × 197 mm)	Paper of this size can be set	Paper of this size can be set	Paper of this size can be set
Statement-R	Paper of this size can be set	Paper of this size can be set	Paper of this size can be set
Statement	Paper of this size can be set	Paper of this size cannot be set	Paper of this size can be set
Folio (210 × 330 mm)	Paper of this size can be set	Paper of this size can be set	Paper of this size can be set
Youkei 4 (105 × 235 mm)	Paper of this size cannot be set	Paper of this size can be set	Paper of this size can be set

Paper Size	Cassette 1	Cassette to 5	Multipurpose Tray
Youkei 2 (114 × 162 mm)	Paper of this size cannot be set	Paper of this size can be set	Paper of this size can be set
Nagagata 3	Paper of this size cannot be set	Paper of this size can be set	Paper of this size can be set
Nagagata 4	Paper of this size cannot be set	Paper of this size can be set	Paper of this size can be set
Yougata 3	Paper of this size cannot be set	Paper of this size can be set	Paper of this size can be set
Size Input	Cassette 1: 105 × 148 to 216 × 356 mm Cassette 2 to 5: 92 × 162 to 216 × 356 mm Multipurpose Tray: 70 × 148 to 216 × 356 mm		

Special Paper

This section describes printing onto special paper and print media.

The following paper and media can be used.

- Transparencies
- Preprint
- Bond paper
- Recycled paper
- Thin paper
- Letterhead
- Colored Paper
- Prepunched paper
- Envelopes
- Hagaki (Cardstock)
- Thick Paper
- Labels
- Coated Paper
- High-quality paper

When using these paper and media, choose those that are designed specifically for copiers or page printers (such as laser printers). Use the multipurpose tray for thick paper, envelopes, cardstocks, and label paper.

Choosing Special Paper

Although special paper that meets the following requirements can be used with the machine, print quality will vary considerably due to differences in the construction and quality of special paper. Thus, special paper is more likely than regular paper to cause printing problems. Before purchasing special paper in volume, try testing a sample to ensure the print quality is satisfactory. General precautions when printing onto special paper are given below. Note that we are not responsible for any harm to the user or damage to the machine caused by moisture or specifications of special paper.

Select a cassette or multipurpose tray for special paper.

Transparencies

Transparencies must be able to withstand the heat of printing. Transparencies must meet the following conditions.

Heat resistance	Must withstand at least 190°C
Thickness	0.100 to 0.110 mm
Material	Polyester
Dimensional accuracy	±0.7 mm
Squareness of corners	90° ±0.2°

To avoid trouble, be sure to load transparencies in portrait orientation (i.e., the longer edge facing the machine). If transparencies jam frequently at output, try pulling the leading edge of sheets gently as they are ejected.

Labels

Be sure to feed labels from the multipurpose tray

For selecting labels, use extreme care so that the adhesive may not come in direct contact with any part of the machine and that the labels are not easily peeled from the carrier sheet. Adhesives that stick to the drum or rollers and peeled labels remaining in the machine may cause a failure.

When printing onto labels, you must be liable for the print quality and possible trouble.



Labels consist of three layers as shown in the illustration. The adhesive layer contains materials that are easily affected by the force applied in the machine. The carrier sheet bears the top sheet until the label is used. This composition of labels may cause more problems.

The label surface must be covered completely with the top sheet. Gaps between labels may cause peeling of labels, resulting in a serious failure.

Some label paper has large margins on the top sheet. When using such paper, do not peel these margins from the carrier sheet before completing output.

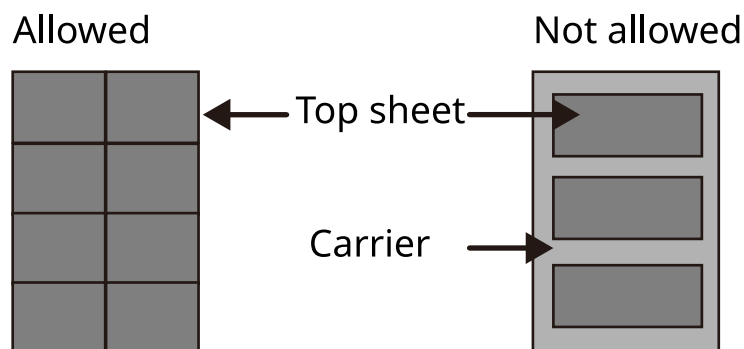

Use label paper that conforms to the following specifications.

Top sheet weight	44 to 74 g/m ²
Basis weight(overall paper weight)	104 to 151 g/m ²
Top sheet thickness	0.086 to 0.107 mm
Overall paper thickness	0.115 to 0.145 mm
Moisture Content	4 to 6 % (composite)

Hagaki (Cardstock)

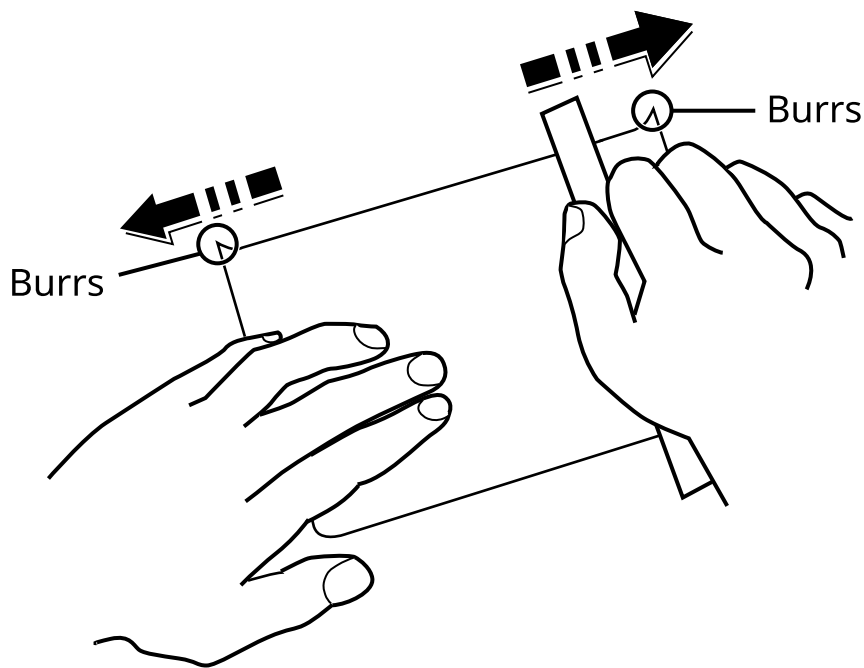

Before loading Hagaki (Cardstock) into the multipurpose tray, fan them and align the edges. If the Hagaki (Cardstock) paper is curled, straighten it before loading. Printing onto curled Hagaki (Cardstock) may cause jams.

Use unfolded Oufuku hagaki (Return postcard) (available at post offices). Some Hagaki (Cardstock) may still have rough edges developed by a paper cutter on the back side. Remove any such rough edges by placing the Hagaki (Cardstock) on a flat surface and rubbing the edges gently a few times with a ruler.

Envelopes

Envelopes should be fed from the MP tray with the print-side down or the cassette and the optional paper feeder with the print-side up.

NOTE

Do not load paper above the load limits located on the paper width guide of the cassette and the optional paper feeder.

Due to the structure of envelopes, printing evenly over the entire surface may not be possible in some cases. Thin envelopes in particular may be wrinkled by the machine in some cases as they pass through. Before purchasing envelopes in volume, try testing a sample to ensure the print quality.

Storing envelopes for a long period may cause them to become wrinkled. Thus, keep the package sealed until you are ready to use them.

Keep the following points in mind.

- Do not use envelopes with exposed adhesive. In addition, do not use the type of envelope in which the adhesive is exposed after the top layer is peeled off. Serious damage may be caused if the paper covering the adhesive comes off in the machine.
- Do not use envelopes with certain special features. For example, do not use envelopes with a grommet for winding a string to close the flap or envelopes with an open or film-covered window.
- If paper jams occur, load fewer envelopes at once.

Thick Paper

Before loading thick paper, fan it and align the edges. Some thick paper may still have rough edges developed by a paper cutter on the back side. Remove any such rough edges just as with Hagaki (Cardstock) by placing the paper on a flat surface and rubbing the edges gently a few times with a ruler. Printing onto paper with rough edges may cause jams.

NOTE

If the paper is not supplied correctly even after it is smoothed, load the paper with the leading edge raised a few millimeters.

Colored Paper

Colored paper must conform to the specifications.

➔ [Basic Paper Specifications \(page 751\)](#)

In addition, the pigments in the paper must be able to withstand the heat of printing (up to 200°C or 392°F).

Preprinted Paper

Preprinted paper must conform to the specifications

➔ [Basic Paper Specifications \(page 751\)](#)

The colored ink must be able to withstand the heat of printing. It must be resistant to silicone oil as well. Do not use paper with a treated surface such as glossy paper used for calendars.

Recycled Paper

Recycled paper must conform to the specifications; however, its whiteness may be considered separately.

➔ [Basic Paper Specifications \(page 751\)](#)

NOTE

Before purchasing recycled paper in volume, try testing a sample to ensure satisfactory print quality.

Coated Paper

Coated paper is created by treating the surface of the base paper with a coating that provides higher printing quality than plain paper. Coated paper is used for particularly high quality printing.

The surface of high-quality or medium-quality paper is coated with special agents that improve ink adhesion by making the paper surface smoother. These agents are used either to coat both sides of the paper or just one side. The coated side appears slightly glossy.

 **IMPORTANT**

When printing on coated paper in very humid environments, ensure that the paper is kept dry as moisture may cause sheets to stick together when they are fed into the machine. If printing in very humid environments, set coated paper for one sheet each.

Specifications

IMPORTANT

Specifications are subject to change without notice.

NOTE

For more information on using the FAX, refer to the following:

➔ [FAX Operation Guide](#)

Machine

Item	Specifications
Type	Desktop
Printing Method	Electrophotography by semiconductor laser
Paper Weight (Cassette)	60 to 163 g/m ²
Paper Weight (Multipurpose Tray)	60 to 220 g/m ²
Paper Type (Cassette)	Plain, Transparency (OHP film), Preprinted, Bond, Recycled, Thin, Letterhead, Color, Prepunched, Thick, High Quality, Custom (Duplex: Same as Simplex except for OHP films.)
Paper Type (Multipurpose Tray)	Plain, Preprinted, Bond, Recycled, Thin, Letterhead, Color, Prepunched, Thick, High Quality, Label, Envelope, Hagaki (Cardstock), Coated, Custom
Paper Size (Cassette)	A4, A5, A5-R, A6, B5, B6, Letter, Legal, 216×340 mm, Executive, Oficio II, 16K, Statement, Statement-R, Folio, ISO B5, Custom (105×140 to 216×356 mm)
Paper Size (Multipurpose Tray)	A4, A5, A5-R, A6, B5, B6, Letter, Legal, 216 × 340 mm, Executive, Oficio II, 16K, Statement, Statement-R, Folio, ISO B5, Envelope Monarch, Envelope #10, Envelope DL, Envelope C5, Envelope #9, Envelope #6 3/4, Hagaki (Cardstock), Oufukuhagaki (Return postcard), Yougata 2, Yougata 4, Nagagata 3, Nagagata 4, Yougata 3, Custom (70×140 to 216×356 mm)
Warm-up Time (23°C/73.4°F, 60%)	26 seconds or less (from power ON)
Warm-up Time (23°C/73.4°F, 60%)	6 seconds or less (from sleep)
Paper Capacity (Cassette)	TASKalfa MA4500ci: 550 sheets (75 g/m ²) TASKalfa MA3500ci: 250 sheets (75 g/m ²) Up to upper limit height line in the cassette.
Paper Capacity (Multipurpose Tray)	100 sheets (75 g/m ²)
Output Tray Capacity (Inner tray)	250 sheets (80 g/m ²)

Item	Specifications
Image Write System	Semiconductor laser and electrophotography
Image Memory	Standard: 2048 MB (On-Board) Maximum: 3072 MB (+ 1024 MB DIMM)
Interface (Standard)	<ul style="list-style-type: none"> • USB Interface Connector: 1 (Super-Speed USB) • Network interface: 1 (10 BASE-T, 100 BASE-TX (TCP/IP, Net BEUI)) • USB Port: 1 (Hi-Speed USB) • Fax: 1
Interface (Option)	eKUIO:1
Operating Environment (Temperature)	10 to 32.5C°
Operating Environment (Humidity)	10 to 80%
Operating Environment (Altitude)	3,500 m/11,482 ft maximum
Operating Environment (Brightness)	1,500 lux maximum
Dimension (W × D × H)	TASKalfa MA4500ci 480 × 577.5 × 602 mm / 18.90" × 22.74" × 23.70" TASKalfa MA3500ci 480 × 577.5 × 575 mm / 18.90" × 22.74" × 22.64"
Weight (without toner container)	TASKalfa MA4500ci 39 kg / 85.98 lb TASKalfa MA3500ci 37 kg / 81.57 lb
Space Required (W × D) (when using multipurpose tray)	480 × 770 mm / 18.90" × 30.32"
Power Source	220-240 V AC, 50 Hz: 5.4 A
The power consumption of the product in networked standby (If all network ports are connected.)	The information is available at the website below. https://www.kyoceradocumentsolutions.eu/en/about-us/our-brand/environmental-policy.html
Options	➔ Overview of Optional Equipment (page 742)

Copy Functions

Copy Speed

TASKalfa MA4500ci

Paper Size	Black and White	Color
A4	45 sheets/min	45 sheets/min
Letter/Statement-R/A5-R	47 sheets/min	47 sheets/min
B5	15 sheets/min	15 sheets/min
A5/Statement	60 sheets/min	60 sheets/min
A6	30 sheets/min	30 sheets/min
Legal	38 sheets/min	38 sheets/min

TASKalfa MA3500ci

Paper Size	Black and White	Color
A4	35 sheets/min	35 sheets/min
Letter/Statement-R/A5-R	37 sheets/min	37 sheets/min
B5	11 sheets/min	11 sheets/min
A5/Statement	47 sheets/min	47 sheets/min
A6	23 sheets/min	23 sheets/min
Legal	30 sheets/min	30 sheets/min

Others

Item	Description
First Copy Time (A4, placed on the platen, feed from Cassette)	<p>TASKalfa MA4500ci</p> <p>Black & White 5.3 seconds or less</p> <p>Color 6.3 seconds or less</p> <p>TASKalfa MA3500ci</p> <p>Black & White 5.7 seconds or less</p> <p>Color 6.8 seconds or less</p>
Zoom Level	Manual mode: 25 to 400%, 1% increments Preset zoom levels: 400%, 200%, 141%, 122%, 115%, 100%, 86%, 81%, 70%, 50%, 25%
Continuous Copying	1 to 998 sheets

Item	Description
Resolution	600 × 600 dpi
Original Type	Sheet, Book, 3-dimensional objects (maximum original size: 216×356 mm)
Original Feed System	Fixed

Printer Function

Print Speed

TASKalfa MA4500ci

Paper Size	Black & White	Color
A4	45 sheets/min	45 sheets/min
Letter/Statement-R/A5-R	47 sheets/min	47 sheets/min
B5	15 sheets/min	15 sheets/min
A5/Statement	60 sheets/min	60 sheets/min
A6	30 sheets/min	30 sheets/min
Legal	38 sheets/min	38 sheets/min

TASKalfa MA3500ci

Paper Size	Black & White	Color
A4	35 sheets/min	35 sheets/min
Letter/Statement-R/A5-R	37 sheets/min	37 sheets/min
B5	11 sheets/min	11 sheets/min
A5/Statement	47 sheets/min	47 sheets/min
A6	23 sheets/min	23 sheets/min
Legal	30 sheets/min	30 sheets/min

Others

Item	Description
First Print Time (A4, feed from Cassette)	<p>TASKalfa MA4500ci</p> <p>Black & White 5.2 seconds or less</p> <p>Color 6.1 seconds or less</p> <p>TASKalfa MA3500ci</p> <p>Black & White 5.4 seconds or less</p> <p>Color 6.7 seconds or less</p>
Resolution	<ul style="list-style-type: none"> • Equivalent of 9600 dpi × 600 dpi • Equivalent of 1200 dpi × Equivalent of 1200 dpi

Item	Description
Operating System	<ul style="list-style-type: none">• Windows 8.1• Windows 10• Windows 11• Windows Server 2012/R2• Windows Server 2016• Mac OS X v10.9 or higher
Interface	<ul style="list-style-type: none">• USB Interface Connector: 1 (Super-Speed USB)• Network interface: 1 (10 BASE-T/100 BASE-TX/1000 BASE-T)• Optional Interface (Option): 1 (For IB-50/IB-51 mounting)• Wireless LAN (Option): 1 (For IB-37/IB-38 mounting)
Page Description Language	PRESCRIBE
Emulation	<ul style="list-style-type: none">• PCL6 (PCL5c/PCL-XL)• KPDL3 AES• PDF Direct Print• XPS

Scanner Functions

Scanning Speed (A4 landscape, 300 dpi, Image quality: Text/Photo original)

When using the document processor (except TWAIN scanning)

TASKalfa MA4500ci

Item	Black and White	Color
1-Sided	60 sheets/min	50 sheets/min
2-Sided	120 sheets/min	100 sheets/min

TASKalfa MA3500ci

Item	Black and White	Color
1-Sided	60 sheets/min	40 sheets/min
2-Sided	100 sheets/min	80 sheets/min

Others

Item	Description
Resolution	<ul style="list-style-type: none"> • 200 dpi x 200 dpi (Default) • 300 dpi x 300 dpi • 200 dpi x 100 dpi • 600dpi x 600dpi • 400dpi x 400dpi • 200dpi x 400dpi
File Format	TIFF (MMR/JPEG compression), JPEG, PDF (MMR/JPEG compression), XPS, PDF/A, High compressive PDF, Encrypted PDF, OPEN XPS, MS Office, Searchable PDF
Interface	Ethernet (10 BASE-T/100 BASE-TX/1000 BASE-T), USB
Transmission System	SMB, SMTP, FTP, FTP over SSL, USB, TWAIN, WIA, WSD

*1 When the optional OCR Scan Activation Kit is installed.

*2 Microsoft Office 2007 or later

*3 Available Operating System: Windows Server 2008/Windows Server 2008 R2/Windows 7/Windows 8/ Windows 8.1/Windows 10/Windows Server 2012/Windows Server 2012 R2/Windows Server 2016

Document Processor

Item	Description
Original Type	Sheet originals
Original Size	Maximum: Legal/Folio Minimum: Statement-R/A6-R
Original Weight	1-sided: 50 to 120 g/m ² 2-sided: 50 to 120 g/m ²
Loading Capacity	100 sheets (50 to 80 g/m ²) maximum Up to upper limit height line in the document processor

Paper Feeder (550-sheet)

Setting	Specifications
Paper Supply Method	Friction roller feeder TASKalfa MA4500ci Capacity 550 sheets (75 g/m ²) × up to 4 cassettes TASKalfa MA3500ci Capacity 550 sheets (75 g/m ²) × up to 3 cassettes
Paper Size	A4, A5-R, B5, Letter, Legal, B6, Folio, 216 × 340 mm, Statement-R, Executive, Oficio II, 16K, ISO B5, Envelope #10, Envelope #9, Envelope #6 3/4, Envelope Monarch, Envelope DL, Envelope C5, Youkei 4, Youkei 2, Custom (92 × 162 to 216 × 356 mm)
Supported Paper	Paper thickness: 60 to 220 g/m ² Media types: Plain, Preprinted, Bond, Recycled, Thin, Letterhead, Color, Prepunched, Thick, High Quality, Custom, Label, Envelope, Coated
Dimensions (W × D × H)	394 × 532 × 116 mm / 15.51" × 20.94" × 4.56"
Weight	4.4 kg / 9.70 lb

Backing up your data

If the SSD or memory of this machine installed in the machine failed for any reason, the files in the box, fax received data and various settings saved there will be deleted and cannot be restored. To prevent erasing data, make regular backups as follows.

- Take a backup using KYOCERA Net Viewer.
 - ➔ [Backing up your data using KYOCERA Net Viewer \(page 769\)](#)
- Take a backup using Command Center RX.
 - ➔ [Backing up your data using Command Center RX \(page 769\)](#)
- Back up your data using a USB drive.
 - ➔ [Backing up your data using USB Drive \(page 770\)](#)

Backing up your data using KYOCERA Net Viewer

Use KYOCERA Net Viewer to regularly back up the data below that is saved on the machine.

- System Settings
- Network Settings
- User List
- Address Book
- Document Box Settings (Except for the file in the Custom Box)
 - ➔ [Migrating the Address Book \(page 133\)](#)

Backing up your data using Command Center RX

Use Command Center RX to regularly back up data saved in the Document Box and Subaddress Box to your PC. This section describes the procedure for backing up the data in the document box. Subaddress box can be backed up using the same procedure.

1 Display the screen.

- 1 Launch your Web browser.
- 2 In the address or location bar, enter the machine's IP address or the host name.
Click in the following order to check the machine's IP address and the host name.
[DeviceInformation] in the home screen > [Identification/Wired Network]
Click the number or name of the Custom Box in which the document is stored.

2 Download Document

- 1 Select the document data you want to download to your PC.
Only the data of one document can be downloaded at a time.
- 2 Click the [Download] icon. The selected document is displayed in [Selected Files].
- 3 Specify the [Image Quality] and [File Format] as needed.
- 4 Click [Download].

Backing up your data using USB Drive

You can copy the data saved in the Custom Box and Subaddress Box to a USB drive. You can save multiple document data at once.

➔ [Copying Documents in Custom Box to USB Drive \(page 294\)](#)

Security Quick Setup Function List

The functions configured in each level of Security Quick Setup are as follows. After selecting the security level, configure the security function according to your operating environment.

TLS

Level 1	Level 2	Level 3
On	On	On

Serverside Settings

The setting item which can be set or configured from Command Center RX.

TLS Version

Level 1	Level 2	Level 3
TLS1.1,TLS1.2,TLS1.3	TLS1.2, TLS1.3	TLS1.2, TLS1.3

Effective Encryption

Level 1	Level 2	Level 3
3DES, AES, AES-GCM, AES, CHACHA20/POLY1305	AES-GCM, AES, CHACHA20/POLY1305	AES-GCM, AES, CHACHA20/POLY1305

Hash

Level 1	Level 2	Level 3
SHA1, SHA-2(256/384)	SHA-2(256/384)	SHA-2(256/384)

IPP Security

Level 1	Level 2	Level 3
Secure Only (IPPS)	Secure Only (IPPS)	Secure Only (IPPS)

HTTPS Security

Level 1	Level 2	Level 3
Secure Only (HTTPS)	Secure Only (HTTPS)	Secure Only (HTTPS)

Enhanced WSD Security

Level 1	Level 2	Level 3
Secure Only (Enhanced WSD over TLS)	Secure Only (Enhanced WSD over TLS)	Secure Only (Enhanced WSD over TLS)

eSCL Security

Level 1	Level 2	Level 3
Non-secure (eSCL over TLS and eSCL)	Secure Only (eSCL over TLS)	Secure Only (eSCL over TLS)

Clientside Settings

The setting item which can be set or configured from Command Center RX.

TLS Version

Level 1	Level 2	Level 3
TLS1.1,TLS1.2,TLS1.3	TLS1.2, TLS1.3	TLS1.2, TLS1.3

Effective Encryption

Level 1	Level 2	Level 3
3DES, AES, AESGCM, CHACHA20/POLY1305	AES-GCM, AES, CHACHA20/POLY1305	AES-GCM, AES, CHACHA20/POLY1305

Hash

Level 1	Level 2	Level 3
SHA1, SHA-2(256/384)	SHA-2(256/384)	SHA-2(256/384)

Certificate Check

Level 1	Level 2	Level 3
	On	On

Certificate check Hash algorithm

Level 1	Level 2	Level 3
	SHA-2(256/384)	SHA-2(256/384)

IPv4 Settings (Wired Network)

The setting item which can be set or configured from Command Center RX.

DNS over TLS

Level 1	Level 2	Level 3
Off	Auto	On

Certificate Auto Verification

Level 1	Level 2	Level 3
Expiration Date	Expiration Date	Expiration Date

Hash

Level 1	Level 2	Level 3
SHA-2(256/384)	SHA-2(256/384)	SHA-2(256/384)

IPv4 Settings (Wireless Network)

The setting item which can be set or configured from Command Center RX.

DNS over TLS

Level 1	Level 2	Level 3
Off	Auto	On

Certificate Auto Verification

Level 1	Level 2	Level 3
Expiration Date	Expiration Date	Expiration Date

Hash

Level 1	Level 2	Level 3
SHA-2(256/384)	SHA-2(256/384)	SHA-2(256/384)

IPv6 Settings (Wired Network)

The setting item which can be set or configured from Command Center RX.

DNS over TLS

Level 1	Level 2	Level 3
Off	Auto	On

Certificate Auto Verification

Level 1	Level 2	Level 3
Expiration Date	Expiration Date	Expiration Date

Hash

Level 1	Level 2	Level 3
SHA-2(256/384)	SHA-2(256/384)	SHA-2(256/384)

IPv6 Settings (Wireless Network)

The setting item which can be set or configured from Command Center RX.

DNS over TLS

Level 1	Level 2	Level 3
Off	Auto	On

Certificate Auto Verification

Level 1	Level 2	Level 3
Expiration Date	Expiration Date	Expiration Date

Hash

Level 1	Level 2	Level 3
SHA-2(256/384)	SHA-2(256/384)	SHA-2(256/384)

Send Protocols: FTP Client (Transmission)

The setting item which can be set or configured from Command Center RX.

Certificate Auto Verification

Level 1	Level 2	Level 3
Expiration Date	Expiration Date	Expiration Date

Hash

Level 1	Level 2	Level 3
SHA-2(256/384)	SHA-2(256/384)	SHA-2(256/384)

Other Protocols: HTTP (Client)

The setting item which can be set or configured from Command Center RX.

Certificate Auto Verification

Level 1	Level 2	Level 3
Expiration Date	Expiration Date	Expiration Date

Hash

Level 1	Level 2	Level 3
SHA-2(256/384)	SHA-2(256/384)	SHA-2(256/384)

Other Protocols: SOAP

The setting item which can be set or configured from Command Center RX.

Certificate Auto Verification

Level 1	Level 2	Level 3
Expiration Date	Expiration Date	Expiration Date

Hash

Level 1	Level 2	Level 3
SHA-2(256/384)	SHA-2(256/384)	SHA-2(256/384)

Other Protocols: LDAP

The setting item which can be set or configured from Command Center RX.

Certificate Auto Verification

Level 1	Level 2	Level 3
Expiration Date	Expiration Date	Expiration Date

Hash

Level 1	Level 2	Level 3
SHA-2(256/384)	SHA-2(256/384)	SHA-2(256/384)

Send Protocols: SMTP (E-mail TX)

The setting item which can be set or configured from Command Center RX.

Certificate Auto Verification

Level 1	Level 2	Level 3
Expiration Date	Expiration Date	Expiration Date

Hash

Level 1	Level 2	Level 3
SHA-2(256/384)	SHA-2(256/384)	SHA-2(256/384)

Email: POP3 User Settings

The setting item which can be set or configured from Command Center RX.

Certificate Auto Verification

Level 1	Level 2	Level 3
Expiration Date	Expiration Date	Expiration Date

Hash

Level 1	Level 2	Level 3
SHA-2(256/384)	SHA-2(256/384)	SHA-2(256/384)

Print protocols

NetBEUI

Level 1	Level 2	Level 3
On	Off	Off

LPD

Level 1	Level 2	Level 3
On	On	Off

FTP (Receiving)

Level 1	Level 2	Level 3
On	Off	Off

IPP

Level 1	Level 2	Level 3
On	Off	Off

IPP over TLS

Level 1	Level 2	Level 3
On		On

Raw

Level 1	Level 2	Level 3
On	On	Off

ThinPrint

Level 1	Level 2	Level 3
On	Off	Off

ThinPrint over TLS

Level 1	Level 2	Level 3
On	Off	Off

WSD Print

Level 1	Level 2	Level 3
On	Off	Off

POP (E-mail RX)

Level 1	Level 2	Level 3
Off	Off	Off

Send Protocol

FTP Client (Transmission)

Level 1	Level 2	Level 3
On	Off	Off

SMB

Level 1	Level 2	Level 3
On	On	Off

WSD Scan

Level 1	Level 2	Level 3
On	Off	Off

DSM Scan

Level 1	Level 2	Level 3
Off	Off	Off

eSCL

Level 1	Level 2	Level 3
On	Off	Off

eSCL over TLS

Level 1	Level 2	Level 3
On	On	Off

Other Protocols

SNMPv1/v2c

Level 1	Level 2	Level 3
On	On	Off

SNMPv3

Level 1	Level 2	Level 3
On	On	Off

HTTP

Level 1	Level 2	Level 3
On	Off	Off

HTTPS

Level 1	Level 2	Level 3
On	On	On

Enhanced WSD

Level 1	Level 2	Level 3
On	Off	Off

Enhanced WSD (TLS)

Level 1	Level 2	Level 3
On	On	On

LDAP

Level 1	Level 2	Level 3
Off	Off	Off

LLTD

Level 1	Level 2	Level 3
Off	Off	Off

VNC (RFB)

Level 1	Level 2	Level 3
Off	Off	Off

VNC (RFB) over TLS

Level 1	Level 2	Level 3
Off	Off	Off

Enhanced VNC (RFB) over TLS

Level 1	Level 2	Level 3
On	Off	Off

TCP/IP: Bonjour Settings

Bonjour

Level 1	Level 2	Level 3
On	On	Off

Network Settings

Wi-Fi Direct Settings

Level 1	Level 2	Level 3
Off	Off	Off

Connectivity

Bluetooth Settings

Level 1	Level 2	Level 3
Off	Off	Off

NFC

Level 1	Level 2	Level 3
Off	Off	Off

Interface Block Setting

USB Host

Level 1	Level 2	Level 3
Unblock	Unblock	Block

USB Device

Level 1	Level 2	Level 3
Unblock	Unblock	Block

Optional Interface

Level 1	Level 2	Level 3
Unblock	Unblock	Block

Energy Saver/Timer

Auto Panel Reset

Level 1	Level 2	Level 3
On	On	On

User Account Lockout Setting

Lockout

Level 1	Level 2	Level 3
Off	Off	On

Job Status/Job Logs Settings

Display Jobs Detail Status

Level 1	Level 2	Level 3
Show All	Show All	Hide All (Display only when Administrator)

Display Jobs Log

Level 1	Level 2	Level 3
Show All	Show All	Hide All (Display only when Administrator)

Display Fax Log

Level 1	Level 2	Level 3
Show All	Show All	Hide All (Display only when Administrator)

Edit Restriction

Address Book

Level 1	Level 2	Level 3
Off	Off	Administrator only

One-Touch Key

Level 1	Level 2	Level 3
Off	Off	Administrator only

Prevent Mis-sending Settings

Destination Check before Send

Level 1	Level 2	Level 3
Off	Off	On

Entry Check for New Dest.

Level 1	Level 2	Level 3
Off	Off	On

New Destination Entry

Level 1	Level 2	Level 3
Permit	Permit	Prohibit

New destination entry (FAX)

Level 1	Level 2	Level 3
Permit	Permit	Prohibit

Recall Destination

Level 1	Level 2	Level 3
Permit	Permit	Prohibit

Broadcast

Level 1	Level 2	Level 3
Permit	Permit	Prohibit

Destination History

Level 1	Level 2	Level 3
Permit	Permit	Prohibit

History Settings

Secure Comm. Error Log

Level 1	Level 2	Level 3
Off	On	On

For the Kyocera contact, see the link in the group directory.

<https://www.kyoceradocumentsolutions.com/company/directory.html>